

Pioneer

MULTI PLAYER

XDJ-1000

<http://pioneerdj.com/support/>

The Pioneer DJ support site shown above offers FAQs, information on software and various other types of information and services to allow you to use your product in greater comfort.

<http://rekordbox.com/>

For various types of information and services regarding rekordbox™, see the Pioneer website above.

<http://kuvo.com/>

Operating Instructions

Contents

How to read this manual

- Thank you for buying this Pioneer product.
Be sure to read both this manual and the Operating Instructions (Quick Start Guide). Both contain important information that you should understand before using this product.
After you have finished reading the instructions, put them away in a safe place for future reference.
- In this document, names of screens, menus and touch keys displayed on the computer screen as well as the names of buttons and terminals on the product etc., are indicated within [] brackets.
Examples:
 - Touch [SLIP].
 - Press the [CUE] button.
 - The [UTILITY] screen is displayed.
 - Click on the Windows [Start] menu button, then [All Programs] > [Pioneer] > [rekordbox 3.x.x] > [rekordbox 3.x.x].
 - Connect the LAN cable properly to the [LINK] terminal.

01 Before start

Features	3
----------------	---

02 Before you start

Supported sources	5
Usable media	5
Playable music file formats	5
Preparing the software	6

03 Connections

Descriptions of terminals.....	7
Basic style.....	7
Using other brands of DJ software	10
Connections for relay play.....	10

04 Part names and functions

Control panel.....	11
Rear panel	13
Normal playback screen (display part)	13
Normal playback screen (touch keys)	14
Performance screen.....	15
Jog dial display section	15

05 Basic Operation

Turning the power on	16
Turning the power off	16
Connecting and disconnecting USB devices	16
Playback	16
Operating the jog dial.....	18

06 Advanced Operation

Setting Cue.....	19
Setting loops	19
Setting Hot Cue.....	20
Storing cue or loop points.....	21
Deleting stored cue or loop points.....	21
Setting the cue point for auto cueing	21
Using beat jump	21
Using loop move	22
Using the slip mode.....	22
Playing from the position on the waveform which was touched	23
Using the beat sync function.....	23
Adjusting the beat grid.....	23
Operating the XDJ-1000 in combination with other devices	23
Browsing tracks.....	24
Other browsing operations.....	25
Checking the playing history (HISTORY)	26
Editing tag lists	26
Displaying the details of the currently loaded track	28

Changing track ratings	28
Displaying details of tracks loaded in other DJ players	28

07 Changing the settings

Storing settings on USB devices.....	29
Calling out settings stored on a USB device.....	29
Changing the color set in the USB.....	29
Displaying the [UTILITY] screen.....	29
Changing the settings.....	29
Duplicating the settings onto DJ players connected by PRO DJ LINK... 31	
Installing the driver software	31

08 Using other brands of DJ software

Operating DJ software by MIDI interface	32
---	----

09 Additional information

Troubleshooting.....	34
About the liquid crystal display	35
Error messages.....	35
Cleaning the touch display	35
List of icons displayed on the main unit display section.....	35
About iPod/iPhone	35
Trademarks, licenses, etc.	36

Before start

Features

This unit is a DJ player equipped with the technology of the Pioneer CDJ series, the world standard for club players. You can play it like a real DJ using the music stored on your USB device, computer or even on mobile devices (smartphones etc.). It is not only equipped with a wide range of features for DJ performances supporting a variety of sources, including the PRO DJ LINK, Quantize and Beat Sync functions. It also has a high sound quality, high reliability design and a panel layout providing high operability, thereby offering strong support for all types of DJ performances.

MULTI MEDIA, MULTI FORMAT

Music files stored on USB devices (flash memory devices or hard disks) and on mobile devices can also be played. The formats of music files that are supported include MP3, AAC, WAV, and AIFF.

The included music management software rekordbox (Mac/Windows) can be used to carefully prepare the play lists, cues, loops and beat grids you will need for DJ performances at home. You can devote your attention to the DJ performance at the disco/club easily. This makes for a deejaying cycle smoothly integrating all the steps, from acquiring the music files to the actual DJ performance.

rekordbox (Mac/Windows)

rekordbox is a software program allowing users who have purchased a Pioneer DJ player supporting rekordbox to manage music files to be used for DJ performances.

The music management software rekordbox can be used for the management (analysis, settings, creation, history storage) of music files on computers. Using music files managed rekordbox in combination with this unit makes it possible to achieve outstanding DJ performances.

- In these operating instructions, the version of rekordbox for Mac/Windows is referred to as "rekordbox (Mac/Windows)". "rekordbox" is used to indicate the versions of rekordbox (Mac/Windows) and rekordbox (iOS/Android) simultaneously, as well as when referring to rekordbox functions directly.

rekordbox (iOS/Android)

rekordbox (iOS/Android), a smartphone application that can be downloaded free of charge, can be used for the management (analysis, settings, creation, history storage) of music files on mobile devices. Using music files managed with rekordbox (iOS/Android) in combination with this unit makes it possible to achieve outstanding DJ performances.

- In these operating instructions, the version of rekordbox for mobile devices is referred to as "rekordbox (iOS/Android)".

PRO DJ LINK

Functions include "USB Export" using USB devices (flash memory drives and hard discs) and "rekordbox LINK Export" using the computer on which rekordbox is installed.

❖ USB Export

This function can be used to transfer rekordbox music files and management data using USB devices. This eliminates the need to take your computer to the disco or club.

At home or in a studio



- Add music files to collections and analyze them.
- Make the preparations on rekordbox.



Write the rekordbox data on a USB device.



At the disco or club

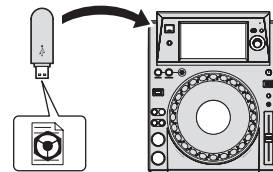

Connect the USB device to the DJ player.

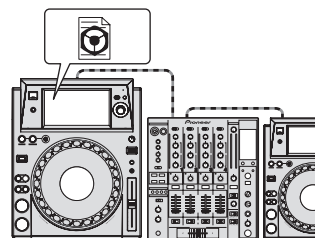

- Use the rekordbox data for the performance.
- Share the rekordbox data using the PRO DJ LINK function.



The playing history is stored on the USB device.



At home or in a studio

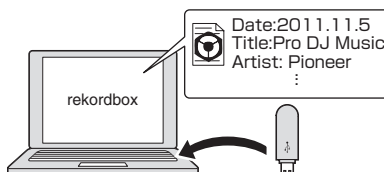

Check and manage the playback history with rekordbox.

❖ rekordbox LINK Export

When this unit and the computer are connected by LAN cable, the rekordbox music files and management can be transferred directly, eliminating the bother of exporting them to a USB device. This unit and the computer can also be connected wirelessly using a wireless LAN router (or wireless LAN access point).

At home or in a studio

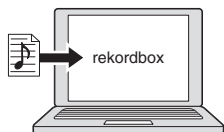

- Add music files to collections and analyze them.
- Make the preparations on rekordbox.



At the disco or club

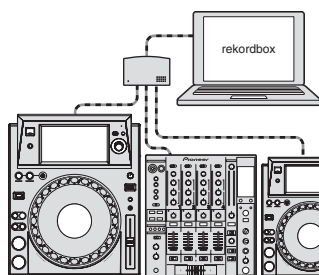

Connect the computer and DJ player.

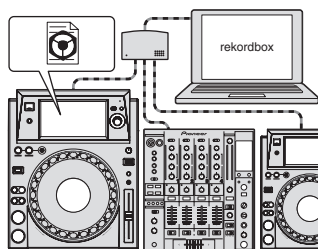

- Use the rekordbox data for the performance.
- Share the rekordbox data using the PRO DJ LINK function.



At home or in a studio

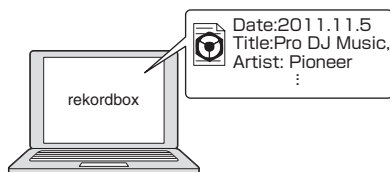

Check and manage the playback history with rekordbox.

TOUCH DISPLAY

This unit is equipped with a large, high-resolution full-color LCD so that the information required for DJ performances is easily visible. This unit not only displays the information required for DJ performances conveniently, but also helps you achieve reliable and aggressive DJ performances through its wide variety of functions including AUTO BEAT LOOP or HOT CUE and BEAT JUMP/LOOP MOVE.

❖ BROWSE

The combination of the list display of music files and an easy-to-operate rotary selector lets you select tracks without stress. In addition, the display of track artwork lets you find the desired tracks instinctively.

❖ KEYWORD SEARCH

A keyboard is displayed on the touch display so that you can type the keywords and search them. It is possible to search the target music files much faster in this manner.

❖ WAVE/WAVE ZOOM

The overall waveform ("WAVE") can be displayed so that you can grasp the overall composition of the track visually. Also, the frequency bands are color-coded, and a zoomable enlarged waveform ("WAVE ZOOM") can be displayed so that the development of the track can be grasped instantaneously.

❖ NEEDLE SEARCH

Just touch the overall waveform (WAVE) with your finger to instantly play the tune next to the touched one. A quick point search can be done by instinctive operation.

❖ BEAT JUMP/LOOP MOVE

You can move the playing position with the specified beat count instantly. A wide range of beats can be improvised without changing the music rhythm.

❖ HOT CUE

This unit has a hot cue that can instantly play back from the cue points that have been set in advance.

❖ AUTO BEAT LOOP

Auto beat loops are prepared for setting loops automatically based on the tempo of the music.

BEAT SYNC

Based on the GRID information of tracks analyzed with rekordbox, the tempo (BPM) and beat position of tracks playing on this unit can automatically be synchronized with other DJ players connected by PRO DJ LINK. The beat sync function helps you mix tracks and create mixing and effect performances, greatly expanding the range of DJ performances.

QUANTIZE

This unit is equipped with a quantize function that automatically corrects the timing when using such functions as looping, reversing or slip looping, even if you perform operations off-beat, as long as the track has been analyzed with rekordbox. This enables accurate performances without breaking the rhythm of the currently playing track.

SLIP MODE

It has a sleep mode function which continues to play back the tracks in background during the Loop/Reverse/Scratch/Pause/Hot Cue/Beat Jump/Loop Move operations. This enables DJ performances without changing the track's development, even after the Loop/Reverse/Scratch/Pause/Hot Cue/Beat Jump/Loop Move.

KUVO

KUVO is a service helping people to enjoy the club culture both inside and outside clubs connecting clubbers, DJs and clubs using the concept of "creating the next generation space to enjoy dance music". See here for the service details.
<http://kuvo.com/>

Before you start

Supported sources

This unit supports the sources listed below.

- USB devices
- Computers (page 17)

Usable media

This unit supports USB mass storage class USB devices (external hard disks, portable flash memory devices, digital audio players, etc.).

Folder layers	Max. 8 layers (files in folders beyond the 8th layer cannot be played)
Max. number of folders	Unlimited (folders beyond the 10 000th folder within a single folder cannot be displayed)
Max. number of files	Unlimited (files beyond the 10 000th file within a single folder cannot be displayed)
Supported file systems	FAT16, FAT32 and HFS+ (NTFS is not supported.)

- Tracks managed by rekordbox can be played by connecting the mobile device on which rekordbox (iOS/Android) is installed via USB. For supported devices, see the Pioneer DJ support website (<http://pioneerdj.com/support/>). For rekordbox (iOS/Android) see the rekordbox (iOS/Android) user's manual.
- When there are many folders or files, some time may be required for loading.
- Folders and files exceeding the limits cannot be displayed.

USB devices that cannot be used

- Optical disc type devices such as external DVD/CD drives, etc., are not supported.

Playable music file formats

This unit supports music files in the formats shown below.

Type	File extension	Compatible formats	Bit depth	Bit rate	Sampling frequency	Encoding method
MP3	.mp3	MPEG-1 AUDIO LAYER-3	16 bit	32 kbps to 320 kbps	32 kHz, 44.1 kHz, 48 kHz	CBR, VBR
		MPEG-2 AUDIO LAYER-3	16 bit	8 kbps to 160 kbps	16 kHz, 22.05 kHz, 24 kHz	CBR, VBR
AAC	.m4a, .aac and .mp4	MPEG-4 AAC LC	16 bit	16 kbps to 320 kbps	16 kHz, 22.05 kHz, 24 kHz, 32 kHz, 44.1 kHz, 48 kHz	CBR, VBR
		MPEG-2 AAC LC	16 bit	16 kbps to 320 kbps	16 kHz, 22.05 kHz, 24 kHz, 32 kHz, 44.1 kHz, 48 kHz	CBR, VBR
WAV	.wav	WAV	16 bit, 24 bit	—	44.1 kHz, 48 kHz	Uncompressed PCM
AIFF	.aif, .aiff	AIFF	16 bit, 24 bit	—	44.1 kHz, 48 kHz	Uncompressed PCM

About MP3 files

MP3 files can have a constant bit rate (CBR) or a variable bit rate (VBR). Both types of files can be played on this unit, but the search and super fast search functions are slower with VBR files. If your priority is operability, we recommend recording MP3 files in CBR.

About AAC files

- AAC is the abbreviation of "Advanced Audio Coding", a basic format of audio compression technology used for MPEG-2 and MPEG-4.
- The file format and extension of AAC data depends on the application used to create the data.
- On this unit, in addition to AAC files encoded with iTunes® and with the extension ".m4a", files with the extensions ".aac" and ".mp4" files can also be played. However, AAC files that are copyright-protected,

- USB hubs cannot be used.
 - iPod cannot be used. (Music data on iPod touch or iPhone can only be played on this unit if it is added to the rekordbox (iOS/Android) library.)
- ⇒ *iPod and iPhone that can be connected to this product (p.8)*

Cautions on using USB devices

- Some USB devices may not operate properly. Please note that Pioneer will accept no responsibility whatsoever for loss of data stored by the user on USB devices or other direct or indirect problems arising due to connection of USB devices to this unit.
- When the current above the permissible level is passed through the USB device insertion slot of this unit, the USB indicator will flash. The communication may be stopped by stopping the power supply to the USB device. To return to normal conditions, please remove the USB device connected to this unit. Avoid re-using the USB device for which the excess current has been detected. If you cannot return to the normal condition (cannot communicate) using the above-mentioned procedure, turn off the power supply unit once and then turn the power on again.
- If multiple partitions are set on the USB device, only the first partition can be used. (When rekordbox library information is present, the partition containing the rekordbox library information has priority.)
- USB devices equipped with flash card readers may not operate.
- Depending on the USB device you are using, the desired performance may not be achieved.

such as those purchased from the iTunes Store, cannot be played. Also, depending on the version of iTunes in which the file was encoded, it may not be possible to play the file.

About ID3 tags

The tag information types which can be registered from a music file are ID3 tags (v1, v1.1, v2.2.0, v2.3.0, and v2.4.0) or meta tags.

About music file artwork

The file format for artwork images that can be added to music files is JPEG (extensions: ".jpg" or ".jpeg").

- Files larger than 800 x 800 dots cannot be displayed.

About character displays

❖ MP3/AAC

When displaying track names, etc., to display characters written in local codes other than Unicode, change the [LANGUAGE] setting.

➤ *Changing the language* (p.30)

Preparing the software

Music management software rekordbox and driver software are not included.

To use rekordbox and the driver software, access the rekordbox site and Pioneer DJ Support site, and download the software.

- The user is responsible for preparing the computer, network devices and other elements of the Internet usage environment required for a connection to the Internet.

About rekordbox

rekordbox is a software program allowing users who have purchased a Pioneer DJ player supporting rekordbox to manage music files to be used for DJ performances.

Music file can be managed in various ways (analysis, setting, creation, history saving) by using the music management software rekordbox. An excellent DJ performance can be achieved by using the music files managed by rekordbox together with this unit.

❖ Acquiring rekordbox (Mac/Windows)

1 Open your web browser on your computer, and access the rekordbox site.

<http://www.rekordbox.com>

2 Click [Download] in the rekordbox site and download rekordbox from the download page.

- For inquiries on rekordbox (Mac/Windows), please see the support site indicated above.

❖ About rekordbox (iOS/Android)

Tracks managed by rekordbox can be played by connecting the mobile device on which the rekordbox (iOS/Android) is installed via USB. For supported devices, see the Pioneer support DJ site (<http://pioneerdj.com/support/>). For rekordbox (iOS/Android), see the rekordbox (iOS/Android) user's manual.

- For details on installing rekordbox (iOS/Android), see the Pioneer website (<http://www.rekordbox.com>).

Cautions on copyrights

rekordbox restricts playback and duplication of copyright-protected music contents.

- When coded data, etc., for protecting the copyright is embedded in the music contents, it may not be possible to operate the program normally.
- When rekordbox detects that coded data, etc., for protecting the copyright is embedded in the music contents, processing (playback, reading, etc.) may stop.

Recordings you have made are for your personal enjoyment and according to copyright laws may not be used without the consent of the copyright holder.

- Music recorded from CDs, etc., is protected by the copyright laws of individual countries and by international treaties. It is the full responsibility of the person who has recorded the music to ensure that it is used legally.
- When handling music downloaded from the Internet, etc., it is the full responsibility of the person who has downloaded the music to ensure that it is used in accordance with the contract concluded with the download site.

Using the online support site

Before making inquiries on rekordbox operating procedures or technical issues, read the rekordbox (Mac/Windows) operating instructions and online manual and check the FAQ provided on the rekordbox online support site.

<rekordbox online support site>

<http://www.rekordbox.com>

Connections

- Be sure to turn off the power and unplug the power cord from the power outlet whenever making or changing connections.
 - Refer to the operating instructions for the component to be connected.
 - Connect the power cord after all the connections between devices have been completed.
- When using a LAN cable for connection, be sure to use either the LAN cable included with this product or an STP (shielded twisted pair) cable.
 - Do not disconnect the LAN cable when music files and/or information are being shared using PRO DJ LINK.

Descriptions of terminals

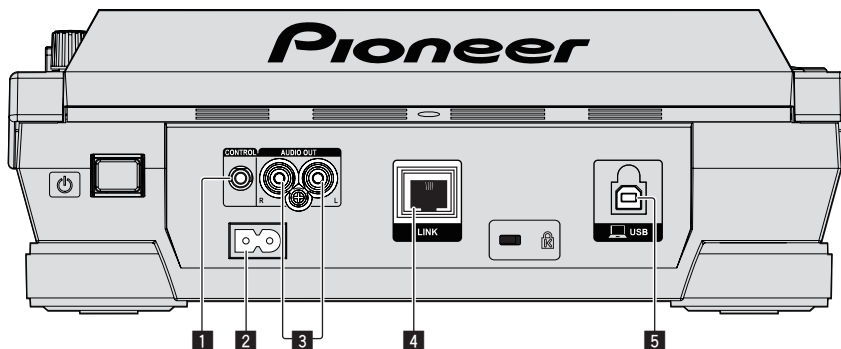

1 CONTROL terminal

This is used to interconnect DJ players with a monaural mini phone plug (Ø 3.5 mm) cable (commercially available) to send control signals for relay playback.

➔ *Connections for relay play* (p.10)

2 AC IN

Connect this to a power outlet.

Connect the power cord after all the connections between devices have been completed.

Be sure to use the included power cord.

3 AUDIO OUT L/R terminals

Connect the audio cables (included) here.

4 LINK terminal

Connect the LAN cable (included) here.

5 USB port

Connect to a computer.

Basic style

Playback on this unit is performed mainly using tracks prepared with rekordbox installed on a computer.

- For rekordbox operations, see the rekordbox (Mac/Windows) user's manual. You can see the rekordbox (Mac/Windows) user's manual from [Help] menu of rekordbox (Mac/Windows).
- Also, for DJ players and DJ mixers, up to four PRO DJ LINK-compatible players can be connected with LAN cables (CAT5e) using PRO DJ LINK connections.
- A switching hub (commercially available) may be necessary, depending on the combination of models used. Use a switching hub of 100 Mbps or greater. Some switching hubs may not operate properly.
- A switching hub (commercially available) is necessary to connect to a mixer equipped with only one LAN port. For mixers with enough LAN ports for all the DJ players and computers in the system, connect directly to the LAN ports on the mixer's rear panel, without using a hub.
- Use the wireless router (available in the market) and access point (available in the market) which can obtain a sufficient communication speed such as IEEE802.11n, IEEE802.11g etc. Depending on the signal conditions in the usage environment or the wireless router and access point, PRO DJ LINK connections may not operate properly.

Connecting to a mixer with only one LAN port

When connecting to a mixer with only one LAN port using a switching hub, for optimum usage of rekordbox's music file management functions, set the channel number of the mixer to which the audio cable is connected and the player number displayed at the bottom left of the main unit display section to the same number.

(Ex.: When the audio cable is connected to channel 1)

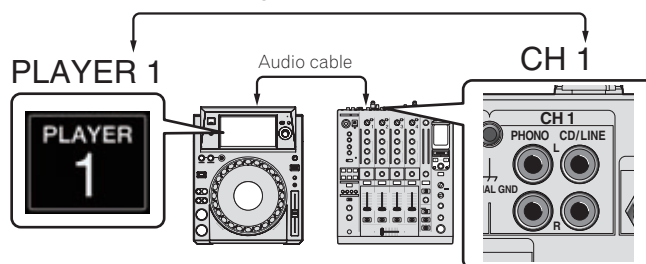

To change the player number, follow the procedure below.

- ① Disconnect the USB device and LAN cable.
- ② Touch **[MENU (UTILITY)]** for over 1 second to display the **[UTILITY]** screen.
- ③ Turn the rotary selector to select **[PLAYER No.]**, then press the rotary selector.
- ④ Turn the rotary selector to select the player number, then press the rotary selector to enter it.

UTILITY	
HISTORY NAME	HISTORY
PLAYER No.	▶ 1
LINK STATUS	CONNECTED
MIDI CHANNEL	8
AUTO STANDBY	OFF
LCD BRIGHTNESS	5
TOUCH DISPLAY CALIBRATION	

- ⑤ Touch **[MENU (UTILITY)]** to complete setting.

PRO DJ LINK (USB Export)

- Without taking a computer into the DJ booth, by using a memory device (flash memory device, hard disk, etc.), rekordbox music files and data can be transferred between this unit and the memory device. This makes it possible to use such information as playlists, cues and loops that have been set ahead of time with rekordbox for performances.

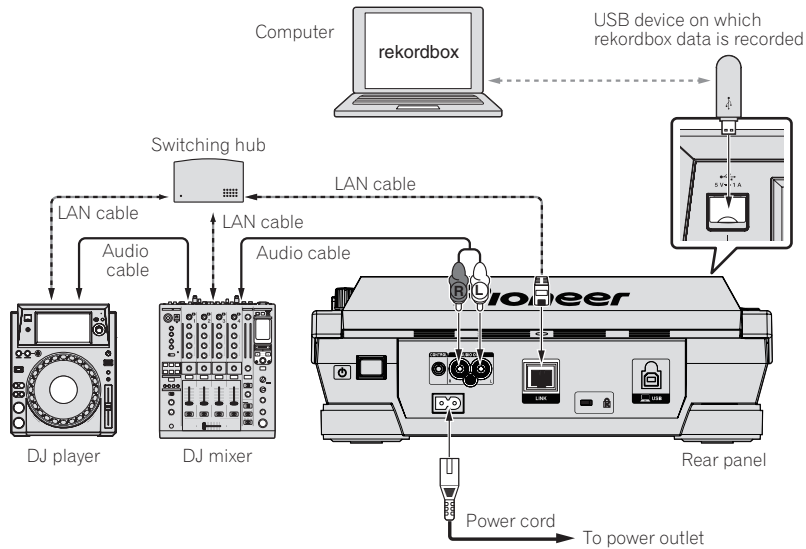

PRO DJ LINK (LINK Export)

- When a computer on which rekordbox is installed is taken into the DJ booth and connected to this unit using a LAN cable (CAT5e) or wireless LAN (Wi-Fi) router, tracks in rekordbox can be selected and played. This makes it possible to use such information as playlists, cues and loops that have been set ahead of time with rekordbox for performances.
- When a mobile device on which rekordbox (iOS/Android) is installed is connected using a USB cable or wireless LAN (Wi-Fi) router, tracks in rekordbox can be selected and played. This makes it possible to use such information as playlists, cues and loops that have been set ahead of time with rekordbox for performances.
- With wired LAN connections, up to two computers on which rekordbox is installed can be connected.
- With wireless LAN (Wi-Fi) connections, up to four computers or mobile devices on which rekordbox is installed can be connected.

iPod and iPhone that can be connected to this product

- This product is compatible with iPhone 6 Plus, iPhone 6, iPhone 5s, iPhone 5c, iPhone 5, iPhone 4s, iPhone 4, iPhone 3GS, and iPod touch (3rd, 4th, 5th generation).
- For the latest supported devices, see the below-mentioned Pioneer support DJ site.
<http://pioneerdj.com/support/>

❖ Using a switching hub

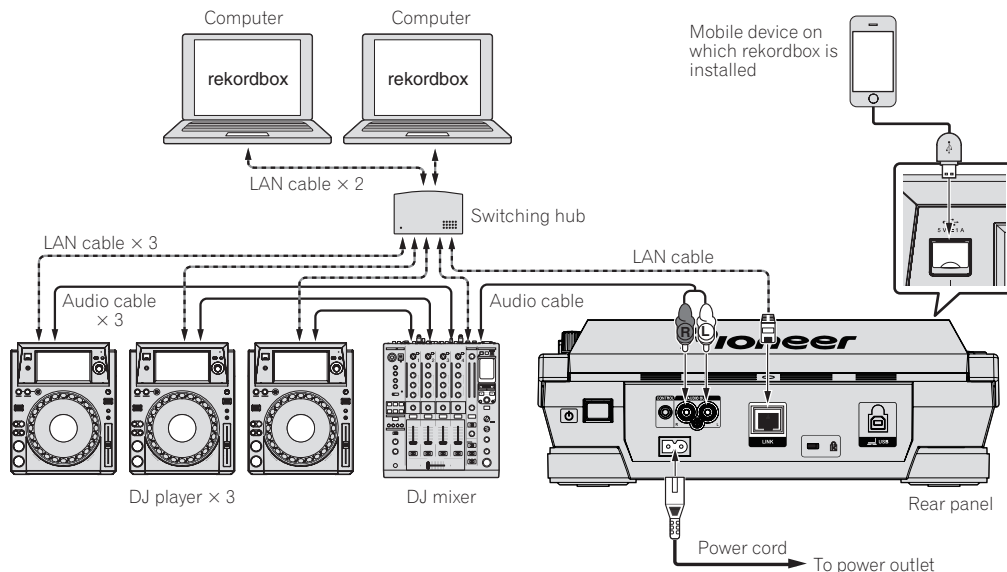

- Use your iPod cable to connect this unit with an iPod or iPhone.
- A switching hub (commercially available) is necessary to connect to a mixer equipped with only one LAN port. For mixers with enough LAN ports for all the DJ players and computers in the system, connect directly to the LAN ports on the mixer's rear panel, without using a hub.

❖ Using a wireless router and access points

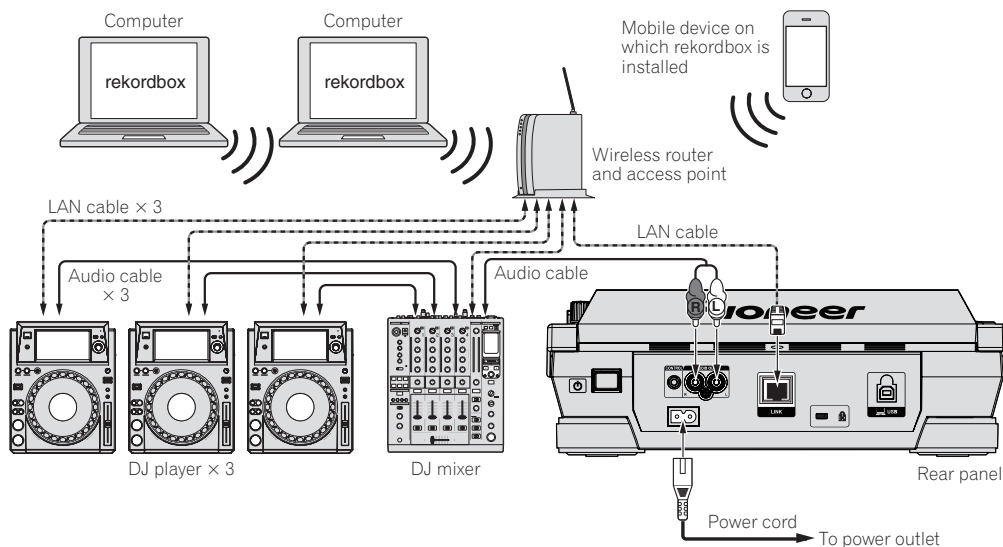

Cautions

In order to maximize the use of music file management functions of rekordbox, please match the player number with the channel of audio cable entered in the mixer.

If the player number is different, change the **[PLAYER No.]** setting on the **[UTILITY]** screen.

- When a storage device is connected to this unit, **[PLAYER No.]** is displayed in gray and cannot be changed. Disconnect the storage device or LAN cable to turn the link off, then change the setting.

Using other brands of DJ software

With this unit, the operating information of the buttons, tempo adjustment dial, etc., can also be output in universal MIDI format. When connected by USB cable to a computer on which MIDI-compatible DJ software is installed, the DJ software can be operated from the XDJ-1000. The sound of music files being played on the computer can also be output from the XDJ-1000. For details, see *Installing the driver software* on page 31 and *Using other brands of DJ software* on page 32.

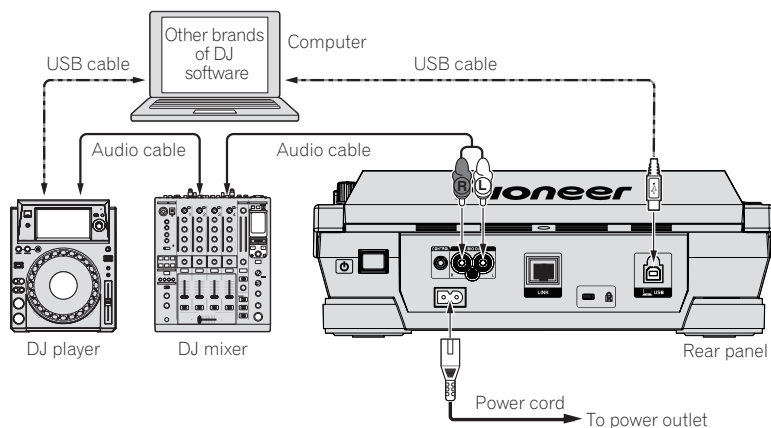

Connections for relay play

When this unit and a Pioneer DJ player are interconnected with their [CONTROL] terminals using a mini phone plug cable (Ø 3.5 mm), relay playback between the two DJ players is possible (page 24).

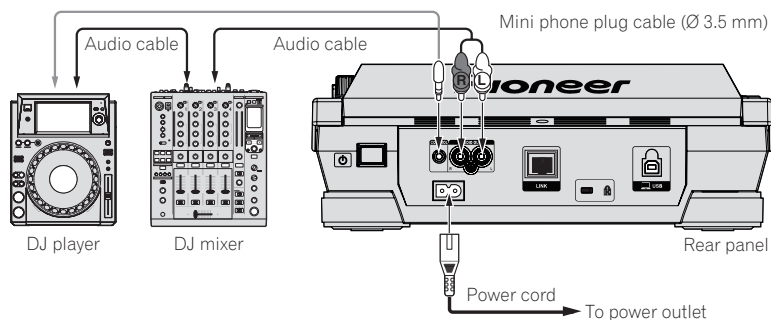

Part names and functions

Control panel

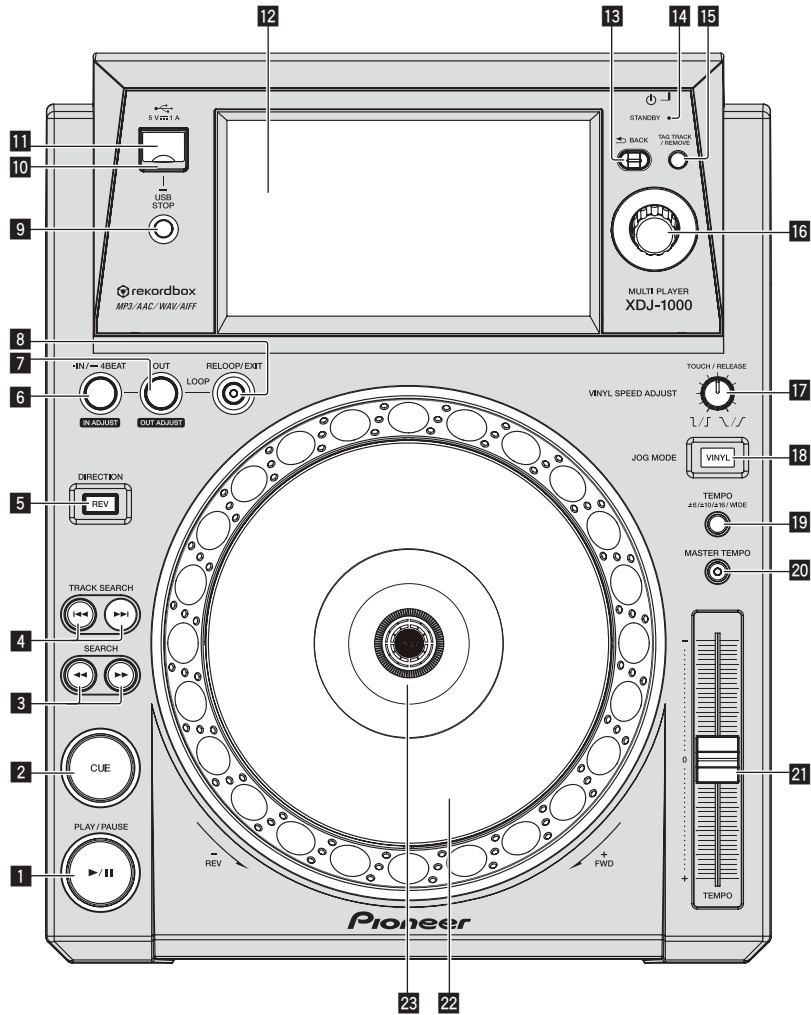

1 PLAY/PAUSE ►/II button

This lights when playing tracks and flashes when in the pause mode.
➔ *Pausing* (p.17)

2 CUE button

This lights when a cue point is set (except during track searching), and flashes when a new cue point can be set in the pause mode.
➔ *Setting Cue* (p.19)

3 SEARCH ◀◀, ▶▶ buttons

The track is forwarded/reversed while the button is held in.
➔ *Forward and reverse scanning* (p.17)

4 TRACK SEARCH ◀◀◀, ▶▶▶ buttons

Use these to search for the beginnings of tracks.
➔ *Finding the beginnings of tracks (Track Search)* (p.17)

5 DIRECTION REV button

Use this to turn reverse playback on and off.
➔ *Playing in reverse* (p.18)

6 IN/4BEAT (IN ADJUST)

Use this to set and fine-adjust the loop in point.
➔ *Setting loops* (p.19)

7 OUT (OUT ADJUST) button

Use this to set and fine-adjust the loop out point.
➔ *Setting loops* (p.19)

8 RELOOP/EXIT button

Use this to return to loop playback (reloop) or cancel loop playback (loop exit).
➔ *Returning to Loop playback (Reloop)* (p.20)

9 USB STOP button

Press for at least 2 seconds before disconnecting the USB device.
➔ *Disconnecting USB devices* (p.16)

10 USB indicator

This flashes when this unit is communicating with the USB device.
➔ *Changing the color set in the USB* (p.29)

11 USB device insertion slot

Load the USB device here.
➔ *Connecting and disconnecting USB devices* (p.16)

12 Touch display

➔ *Normal playback screen (display part)* (p.13)

13 BACK button

Press this once to return to the previous screen.

Press for over 1 second to move to the top layer.

↻ *Playing media connected to or inserted in this unit* (p.16)

14 STANDBY indicator

This lights when in the standby mode.

↻ *Setting the auto standby mode* (p.30)

15 TAG TRACK/REMOVE button

Use these to add and remove tracks from the tag list.

↻ *Editing tag lists* (p.26)

16 Rotary selector

When selecting tracks or setting items, the cursor moves when the rotary selector is turned. Press the rotary selector to enter.

17 VINYL SPEED ADJUST TOUCH/RELEASE control

↻ *Adjusting the speed at which playback slows then stops when the top of the jog dial is pressed and the speed at which playback returns to normal when the top of the jog dial is released.* (p.18)

18 JOG MODE VINYL button

The mode switches between VINYL and CDJ each time this is pressed. When the VINYL mode is selected, the indicator lights.

↻ *Switching the jog dial mode* (p.18)

19 TEMPO ±6/±10/±16/WIDE button

Use this to switch the playing speed adjustment range.

↻ *Adjusting the playing speed (Tempo control)* (p.17)

20 MASTER TEMPO button

Use this to turn the master tempo function on and off.

↻ *Adjusting the playing speed without changing the pitch (Master Tempo)* (p.18)

21 TEMPO slider

Use this to adjust the track playing speed.

↻ *Adjusting the playing speed (Tempo control)* (p.17)

22 Jog dial

This can be used for such operations as scratching, pitch bending, etc.

↻ *Operating the jog dial* (p.18)

23 Jog dial display section

↻ *Jog dial display section* (p.15)

Rear panel

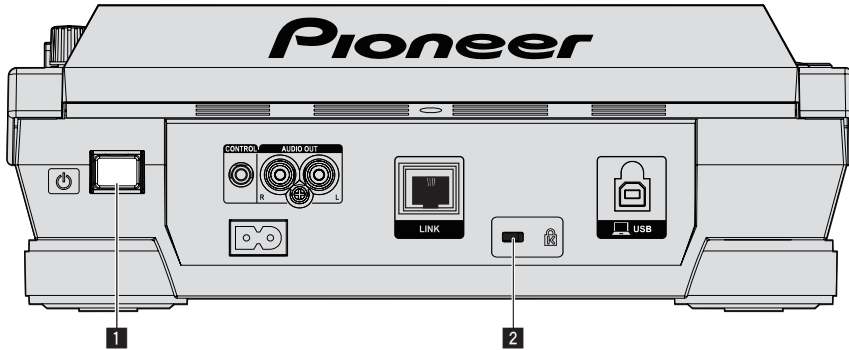

For the terminals used for connections, see *Descriptions of terminals* on page 7.

- 1** **switch**
Turns this unit's power on and off.
- 2** **Kensington security slot**

Normal playback screen (display part)



- 1 Information display section**
The enlarged waveform analyzed with rekordbox, etc., is displayed here.
- 2 Player number (1 – 4)**
This indicates the player number (1 – 4) assigned to this unit.
- 3 Track names**
- 4 Phase Meter**
This indicates the amount of divergence of the bars and beats with the master player when using the beat sync function.
- 5 Beat count down**
This indicates the number of bars or beats from the currently playing position to the nearest stored cue point.
- 6 Key**
This indicates the track's key.
- 7 REMAIN**
This lights when the time display is set to the remaining time.
- 8 A. CUE**
This lights when auto cue is set.
➔ *Setting auto cue* (p.19)
- 9 QUANTIZE**
This is displayed when the quantize function is ON.
- 10 Time display (minutes, seconds and msec)**
This displays the remaining time or elapsed time.
- 11 ZOOM and GRID ADJUST mode display**
When the rotary selector is pressed for over 1 second, the mode switches between the [ZOOM] mode and the [GRID ADJUST] mode.
 - [ZOOM] mode: The waveform zooms in or out when the rotary selector is turned.
 - [GRID ADJUST] mode: When the rotary selector is turned, the beat grid is adjusted.
 ➔ *Adjusting the beat grid* (p.23)
- 12 MT**
This lights when the master tempo is set.
➔ *Adjusting the playing speed without changing the pitch (Master Tempo)* (p.18)
- 13 Playing speed display**
The value changes according to the position of the [TEMPO] slider.
- 14 BPM display**
Displays BPM (Beats Per Minute) of the track currently being played.
 - The BPM measured by this unit may differ from the BPM indicated on the audio source or that of a Pioneer DJ mixer, etc. This is due to the different methods used for measuring the BPM, and is not a malfunction.

15 Loop beat display

Beat count set in the loop is displayed.

16 Playing speed adjustment range display

This indicates the range in which the playing speed can be adjusted with respect to the original playing speed recorded on the medium.

17 Waveform display

This displays the sound as a waveform.

18 Playing address display/scale display (1-minute intervals)

The track is displayed as a bar graph. The current playback position is displayed as a white vertical line. When the elapsed time is displayed, the left edge of the graph lights. When the remaining time is displayed, the display turns off from the left side. The entire graph flashes slowly when there are less than 30 seconds remaining in the track, then begins flashing rapidly when less than 15 seconds remain.

19 Cue point, hot cue point and loop point display

This displays the position of cue point, hot cue point and loop point that have been set using the mark.

20 Cue/loop point memories

Cue and loop points recorded on USB devices are displayed as marks.

21 Cache meter

This indicates how much of the currently playing track is cached in the memory.

22 Track number display

This indicates the track number (01 – 999).

Normal playback screen (touch keys)



1 SLIP

⇨ Using the slip mode (p.22)

2 LOOP MODE

⇨ Setting the loop automatically based on the track's tempo (Auto Beat Loop) (p.20)

3 USB

Touch to play a music file stored on a USB device.
⇨ Playing media connected to or inserted in this unit (p.16)

4 LINK

Touch to play a music file on some other DJ player.
⇨ Playing music files on other DJ players (p.17)

5 rekordbox

Touch to play a music file on rekordbox.
⇨ Playing the rekordbox library on a computer or mobile device (p.17)

6 BROWSE (SEARCH)

Touch to display the Browse screen.
Touch [BROWSE (SEARCH)] for over 1 second to search tunes.
⇨ Switching to the browse screen (p.24)
⇨ Searching for tracks (p.25)

7 TAG LIST

Touch to display the Tag list screen.
⇨ Editing tag lists (p.26)

8 INFO (LINK INFO)

Touch to display track details.
If you touch and hold [INFO (LINK INFO)] for over 1 second, the details of the track loaded in another DJ player are displayed.
⇨ Displaying the details of the currently loaded track (p.28)

9 MENU (UTILITY)

Touch to display menu screen.
If you touch for over 1 second, [UTILITY] screen is displayed.
⇨ Displaying the [UTILITY] screen (p.29)

10 PERFORM

Touch to display the Performance screen.

11 CUE/LOOP CALL ◀(LOOP 1/2X), ▶(LOOP 2X)

Use these to call out stored cue and loop points.
⇨ Calling out stored cue or loop points (p.21)
When pressed during loop playback, the loop is cut or extended.
⇨ Cutting loops (Loop Cut) (p.20)
⇨ Extending loops (loop doubling) (p.20)

12 MEMORY (DELETE)

Use this to store cue and loop points in the memory.
If you continue to touch and hold for over 1 second, the cue point or loop point is deleted.
⇨ Storing cue or loop points (p.21)

13 QUANTIZE

Touch to use the quantize function.

When the quantize function is set to on, the point is automatically set to the nearest beat position when a loop in point, loop out point or cue is set.

Also, looping, reversing, slipping, etc., can be used without breaking the beat.

- When the quantize function is set to on, [QUANTIZE] is displayed on the main unit display.

The quantize function is disabled (displayed in gray color) when you play a music file which is not analyzed by rekordbox.

14 BEAT SYNC

Use this to turn on the beat sync function.

- ➔ *Using the beat sync function (p.23)*

15 BEAT SYNC MASTER

Use this to set the track loaded in this unit as the master for the beat sync function.

- ➔ *Using the beat sync function (p.23)*

16 TIME (A. CUE)

When touched, the time display (remaining time display or elapsed time display) gets switched on.

When touch and hold for over 1 second, the auto cue turns on/off.

- ➔ *Setting auto cue (p.19)*

17 Waveform display

➔ *Playing from the position on the waveform which was touched (p.23)*

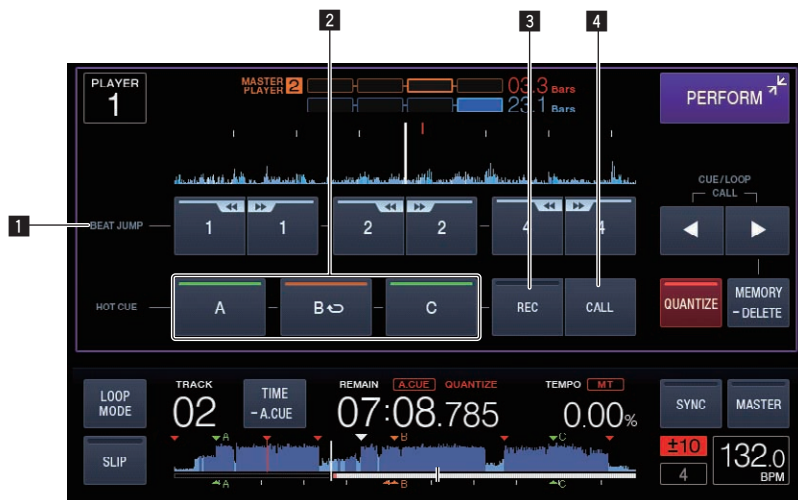
Performance screen**1 BEAT JUMP (LOOP MOVE)**

Loop move function can be used in loop status.

- ➔ *Using beat jump (p.21)*
- ➔ *Using loop move (p.22)*

2 HOT CUE (A,B,C)

- ➔ *Playing hot cues (p.20)*

3 HOT CUE (REC)

- ➔ *Setting Hot Cue (p.20)*

4 HOT CUE (CALL)

- ➔ *Calling out hot cues (p.21)*

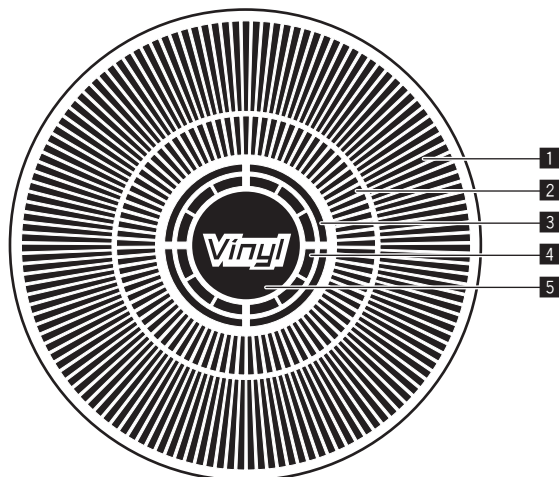
Jog dial display section**1 Operation display**

This displays a playback position with 1 loop of 1.8 seconds. It turns during playback and stops in the pause mode.

2 Cue point display/slip play display**3 Audio memory status display**

This flashes when the audio memory is being written. It stops flashing, remaining lit, when writing is completed.

It may not be possible to perform the real time cue operation while the audio memory is being written.

The display also flashes when there is not enough memory due to scratch play.

4 Jog touch detection display

When the jog mode is set to VINYL, the top of the jog dial lights when pressed.

5 VINYL

This lights when the jog mode is set to VINYL.

- ➔ *Switching the jog dial mode (p.18)*

Basic Operation

Turning the power on

1 Make all the connections, then plug the power cord into a power outlet.

⇒ *Connections* (p.7)

2 Press the [⏻] switch.

This unit's indicators light and the power turns on.

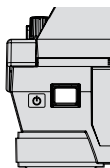

Turning the power off

Press the [⏻] switch.

This unit's power turns off.

- Do not remove the USB device or turn Off the power of the unit while the USB indicator is blinking. The management data in the unit may get deleted. Also, the USB device may become unreadable.

Connecting and disconnecting USB devices

Connecting USB devices

1 Press the [⏻] switch to turn this unit's power on.

2 Open the cover of the USB device insertion slot and connect the USB device.

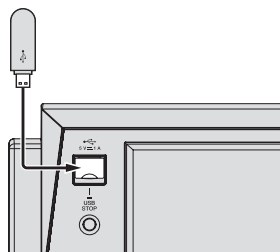

The indicator blinks during communication.

The color of the USB indicator changes to the color set in the USB device.

⇒ *Changing the color set in the USB* (p.29)

Disconnecting USB devices

1 Press and hold the [USB STOP] button until the USB indicator stops flashing.

- Do not remove the USB device or turn Off the power of the unit while the USB indicator is blinking. The management data in the unit may get deleted. Also, the USB device may become unreadable.

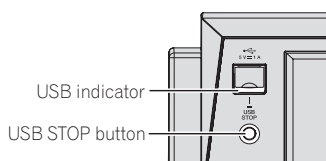

2 Disconnect the USB device.

3 Close the cover of the USB device insertion slot.

Playback

This section describes basic track selection operations and how to switch the screen.

⇒ *Playing music files on other DJ players* (p.17)

⇒ *Playing the rekordbox library on a computer or mobile device* (p.17)

Playing media connected to or inserted in this unit

1 Load the medium in this unit.

⇒ *Connecting USB devices* (p.16)

2 Touch [USB].

The tracks or folders are displayed on a list.



The contents of the media to be displayed on the main unit display can be switched.

- [USB]: Displays the contents of the connected USB device and mobile devices.
- When you touch [LINK], other music files in the DJ player will be displayed.
- When you touch [rekordbox], music files in rekordbox will be displayed.
- If the rekordbox library information was written on the USB device, the rekordbox library is displayed.

⇒ *Playing the rekordbox library on a computer or mobile device* (p.17)

3 Turn the rotary selector.

Move the cursor and select the item.

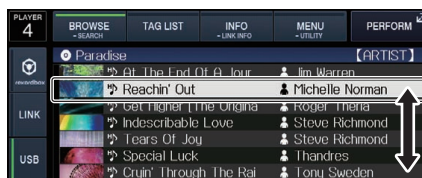

- Press the rotary selector to move to a lower level in the folder. Press the [BACK] button to return to the level above.
- When the [BACK] button is pressed for over 1 second or the medium button for the medium being browsed is pressed, the display moves to the topmost level.
- Tracks in the currently playing track's category/folder can also be selected using the [TRACK SEARCH] buttons.

4 Select the track and press the rotary selector.

When the track is loaded, the screen switches to the normal playback screen.

⇒ *Normal playback screen (display part)* (p.13)

- When [LOAD LOCK] on the [UTILITY] menu is set to [LOCK], it is not possible to load other tracks during playback. Either set [LOAD LOCK] to [UNLOCK] or press the [PLAY/PAUSE] button to pause, then load the track.
- When auto cue is turned on, the disc pauses at the audio start position. In this case, press the [PLAY/PAUSE] button to start playback.

⇒ *Setting auto cue* (p.19)

Playing music files on other DJ players

The contents of the mobile device in which rekordbox is installed, or storage device installed in other players connected to PRO DJ LINK, are displayed on the unit screen.

1 Set the storage device, or mobile device in which rekordbox is installed, to another player while is connecting to PRO DJ LINK.

2 Touch [LINK].

The tracks and folders of the recording medium connected to another player or of the mobile device on which rekordbox is installed are displayed.

- When multiple media are connected, a screen for selecting the medium appears.
- If the rekordbox library information was written on the USB device, the rekordbox library is displayed.
 - ➔ *Playing the rekordbox library on a computer or mobile device* (p. 17)

3 Turn the rotary selector.

Move the cursor and select the item.

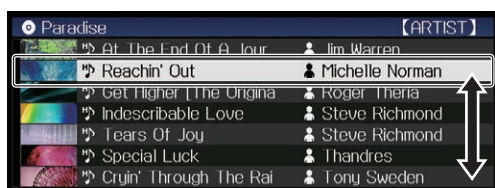

4 Select the track and press the rotary selector.

When the track is loaded, the screen switches to the normal playback screen.

The track is loaded and playback starts.

- ➔ *Normal playback screen (display part)* (p.13)

❖ If the medium contains the rekordbox library

rekordbox library information is displayed when the rekordbox library information is written in the USB device set in this unit or in another DJ player that is connected to this unit or PRO DJ LINK.

- Music files are displayed in the categories (album, artist, etc.) set with rekordbox.
- The types of items on the category menu can be changed in rekordbox's preferences.

Playing the rekordbox library on a computer or mobile device

Music files are displayed in the categories (album, artist, etc.) set with rekordbox.

1 Touch [rekordbox].

The rekordbox library is displayed on this unit's main unit display.

- With wireless LAN (Wi-Fi) connections, if **[Please push the rotary selector to permit mobile connection.]** appears on this unit's main unit display when connecting, connection is possible by pressing the rotary selector.
- Touch [USB] when you want to select a mobile device connected to USB.
Touch [LINK] when you want to select a mobile device connected to other DJ players connected to PRO DJ LINK.

2 Turn the rotary selector.

Move the cursor and select the item.

3 Select the track and press the rotary selector.

When the track is loaded, the screen switches to the normal playback screen.

The track is loaded and playback starts.

- ➔ *Normal playback screen (display part)* (p.13)

Load previous tracks

The names of the last seven tracks that were played can be displayed and these tracks can be selected.

1 Display the normal playback screen.

- ➔ *Normal playback screen (display part)* (p.13)

2 Touch [MENU (UTILITY)].

3 Turn the rotary selector to select the track, then press the rotary selector to set playback.

- If you touch [MENU (UTILITY)] or press [BACK] button, the song name display turns Off.

Pausing

During playback, press the [PLAY/PAUSE ►/II] button.

The [PLAY/PAUSE ►/II] and [CUE] buttons flash. When the [PLAY/PAUSE ►/II] button is pressed again, playback resumes.

Forward and reverse scanning

Press one of the [SEARCH ◀◀, ▶▶] buttons.

The track is scanned in the forward or reverse direction while one of the [SEARCH ◀◀, ▶▶] buttons is pressed.

- It is not possible to move to a different category or folder during forward or reverse scanning.

Finding the beginnings of tracks (Track Search)

Press one of the [TRACK SEARCH ◀◀, ▶▶] buttons.

Press the [▶▶] to move to the beginning of the next track.

When [◀◀] is pressed, playback returns to the beginning of the currently playing track. When pressed twice in a row, playback returns to the beginning of the previous track.

- It is not possible to move to a different category or folder with the track search function.
- rekordbox (iOS/Android) tracks operate in the single mode, so searching for the beginnings of other tracks is not possible.

Adjusting the playing speed (Tempo control)

Press the [TEMPO ±6/±10/±16/WIDE] button.

The [TEMPO] slider's adjustment range switches each time the button is pressed. The adjustment range setting is indicated on the main unit display.

Setting value	Units of adjustment
±6	0.02 %
±10	0.05 %
±16	0.05 %
WIDE	0.5 %

The [WIDE] adjustment range is ±100 %. When set to -100 %, playback stops.

- The adjustment range is set to ±10 % when the power is turned on.

Move the [TEMPO] slider forward or backward.

The tempo increases when moved to the [+] side (down), decreases when moved to the [-] side (up). The rate at which the playing speed is changed is indicated on the playing speed display.

Adjusting the playing speed without changing the pitch (Master Tempo)

1 Press the [MASTER TEMPO] button.

The [MASTER TEMPO] button and [MT] indicator on the main unit display light.

2 Move the [TEMPO] slider forward or backward.

The pitch does not change even when the playing speed is changed with the [TEMPO] slider.

- The sound is digitally processed, so the sound quality decreases.

Playing in reverse

- When the quantize function is on, there may be a slight delay in operation of this function in order to synchronize the beat.

Press the [DIRECTION REV] button.

The button lights and reverse playback starts.

- When the music files are recorded in a folder structure, only tracks within the same category/folder can be played in reverse. Also note that reverse playback may not start immediately.
- The direction in which the playing speed is increased or decreased according to the direction in which the jog dial is turned is reversed.
- When such operations as track searching and loop playback are performed during reverse playback, the audio memory status display on the jog dial display section flashes and scratch play may not be possible.

Operating the jog dial

- The top of the jog dial has an embedded switch. Do not place objects on the jog dial or subject it to strong forces.
- Water or other liquids getting into the set will lead to malfunction.

Switching the jog dial mode

Press the [JOG MODE VINYL] button.

The mode switches between VINYL and CDJ each time the button is pressed.

- VINYL mode: When the top of the jog dial is pressed during playback, playback stops, and when the jog dial is spun at this time sound is produced according to the direction in which the jog dial is spun.
- CDJ mode: Playback does not stop even when the top of the jog dial is pressed. Such operations as scratching cannot be performed.

Pitch bend

During playback, spin the outer section of the jog dial without touching the top.

The playing speed increases when spun clockwise, decreases when spun counterclockwise. When spinning is stopped, playback returns to the normal speed.

- When the jog mode is set to the CDJ mode, the same operation can be performed by spinning the top of the jog dial.

Scratch

When the jog mode is set to the VINYL mode, tracks can be played according to the direction and speed at which the jog dial is spun by spinning the top of the jog dial while pressing it.

1 Press the [JOG MODE VINYL] button.

Set the jog mode to VINYL.

2 During playback, press the top of the jog dial.

Playback slows then stops.

3 Spin the jog dial in the desired direction and at the desired speed.

The sound is played according to the direction and speed at which the jog dial is spun by spinning the top of the jog dial while pressing it.

4 Release your hand from the top of the jog dial.

Normal playback resumes.

Frame search

In the pause mode, spin the jog dial.

The position at which the track is pausing can be moved in units of 0.5 frames.

- The approximate time for 0.5 frame is 6.7 msec.
- The position is moved in the direction of the playback when the jog dial is spun clockwise, in the reverse direction when it is spun counterclockwise. The position moves 1.8 seconds for one revolution of the jog dial.

Super fast search

Turn the jog dial while pressing one of the [SEARCH ◀◀, ▶▶] buttons.

The track is fast-forwarded/fast-reversed in the direction in which the jog dial is spun.

- When the [SEARCH ◀◀, ▶▶] button is released, this function is canceled.
- When you stop the jog dial from spinning, normal playback resumes.
- The fast-forward/fast-reverse speed can be adjusted according to the speed at which the jog dial is spun.

Super fast track search

Turn the jog dial while pressing one of the [TRACK SEARCH ◀◀, ▶▶] buttons.

The track is advanced at high speed in the direction in which the jog dial was turned.

Adjusting the speed at which playback slows then stops when the top of the jog dial is pressed and the speed at which playback returns to normal when the top of the jog dial is released.

Turn [VINYL SPEED ADJUST TOUCH/RELEASE].

The speed increases when turned clockwise, decreases when turned counterclockwise.

- When the jog mode set to the VINYL mode, the speed at which playback starts and stops when [PLAY/PAUSE▶/II] is pressed changes simultaneously.

Advanced Operation

Setting Cue

1 During playback, press the [PLAY/PAUSE ►/II] button.
Playback is paused.

2 Press the [CUE] button.

The point at which the track is paused is set as the cue point.
The [PLAY/PAUSE ►/II] indicator flashes and the [CUE] indicator lights.
No sound is output at this time.

- When a new cue point is set, the previously set cue point is canceled.

Adjusting the cue point position

1 Press the [SEARCH ◀◀, ▶▶] buttons while pausing at the cue point.

The [PLAY/PAUSE ►/II] and [CUE] indicators flash.

2 Press one of the [SEARCH ◀◀, ▶▶] buttons.

The cue point can be fine-adjusted in steps of 0.5 frames.

- The same operation is possible using the jog dial.

3 Press the [CUE] button.

The position at which the button was pressed is set as the new cue point.

- When a new cue point is set, the previously set cue point is canceled.

Returning to Cue Point (Back Cue)

During playback, press the [CUE] button.

The set immediately returns to the currently set cue point and pauses.

- When the [PLAY/PAUSE ►/II] button is pressed, playback starts from the cue point.

Checking Cue Point (Cue Point Sampler)

Keep pressing the [CUE] button after returning to the cue point.

Playback starts from the set cue point. Playback continues while the [CUE] button is pressed.

- If the [PLAY/PAUSE ►/II] button is pressed while sampling the cue, playback continues even if the [CUE] button is released.

Setting Cue Point during playback (Real Time Cue)

During playback, press the [IN/4BEAT (IN ADJUST)] button at the point at which you want to set the cue point.

The point at which the button was pressed is set as the cue point.

Setting auto cue

When a track is loaded or the track search operation is performed, the silent section at the beginning of the track is skipped and the cue point is automatically set at the point immediately before the sound starts.

Touch [TIME (A. CUE)] for over 1 second.

[A. CUE] lights.

- If you touch and hold [TIME (A. CUE)] for over 1 second again, auto cue is set to Off.
- The auto cue level setting remains in the memory, even when the power is turned off.

Setting loops

This function can be used to play specific sections repeatedly.

- When the quantize function is on, there may be a slight delay in operation of this function in order to synchronize the beat.

1 During playback, press the [IN/4BEAT (IN ADJUST)] button at the point at which you want to start loop playback (the loop in point).

Loop In Point is set.

- This operation is not necessary if you want to set the currently set cue point as the loop in point.

2 Press the [OUT (OUT ADJUST)] button at the point at which you want to end loop playback (the loop out point).

The loop out point is set, and loop playback begins.

Fine-adjusting the loop in point (loop in adjust)

1 During loop playback, press the [IN/4BEAT (IN ADJUST)] button.

The [IN/4BEAT (IN ADJUST)] button starts flashing rapidly, and the [OUT (OUT ADJUST)] button turns off.

The loop in point's time is displayed on the main unit display.

2 Press one of the [SEARCH ◀◀, ▶▶] buttons.

The loop in point can be adjusted in units of 0.5 frames.

- The same operation is possible using the jog dial.
- The loop in point's range of adjustment is ± 30 frames.
- The loop in point cannot be set at a point beyond the loop out point.

3 Press the [IN/4BEAT (IN ADJUST)] button.

Loop playback resumes.

- Normal loop playback also resumes if no operation is performed for over 10 seconds.

Fine-adjusting the loop out point (loop out adjust)

1 During loop playback, press the [OUT (OUT ADJUST)] button.

The [OUT (OUT ADJUST)] button starts flashing rapidly, and the [IN/4BEAT (IN ADJUST)] button turns off.

The loop out point's time is displayed on the main unit display.

2 Press one of the [SEARCH ◀◀, ▶▶] buttons.

The loop out point can be adjusted in units of 0.5 frames.

- The same operation is possible using the jog dial.
- The loop out point cannot be set at a point before the loop in point.

3 Press the [OUT (OUT ADJUST)] button.

Loop playback resumes.

- Normal loop playback also resumes if no operation is performed for over 10 seconds.

Canceling Loop playback (Loop Exit)

During loop playback, press the [RELOOP/EXIT] button.

Playback continues beyond the Loop Out Point without returning to the Loop In Point.

Returning to Loop playback (Re-loop)

After canceling loop playback, press the **[RELOOP/EXIT]** button during playback.

Playback returns to the previously set Loop In Point, and Loop playback resumes.

Setting the loop automatically based on the track's tempo (Auto Beat Loop)

A loop with the specified number of beats is set and loop playback starts.

1 Touch **[LOOP MODE]** during playback.

The beat number selection screen appears on the main unit display.

- The beat select screen is also displayed when loops are set and when the slip function is turned on.

2 Touch the beat you want to set.



Loop playback starts with the selected beat.

3 Touch **[LOOP MODE]**.

The beat number selection screen turns off.

- The beat select screen also turns off when a track is loaded.
- When a track that has not been analyzed is playing, the loop is set according to the track's BPM.
- If the track's BPM cannot be detected, the BPM is set to 130.

❖ 4 beat loop

During playback, press the **[IN/4BEAT (IN ADJUST)]** button for over 1 second.

A loop of 4 beats starting from the point at which the button was pressed is set automatically according to the BPM of the currently playing track, and loop playback starts.

- If the track's BPM cannot be detected, the BPM is set to 130.

Cutting loops (Loop Cut)

Touch **[LOOP 1/2X]** during loop playback.

The Loop playing time is cut in half each time the touch key is touched.

Extending loops (loop doubling)

Touch **[LOOP 2X]** during loop playback.

The Loop playing time is doubled each time the touch key is touched.

Using active loops

Load a track for which an active loop has been set with rekordbox.

One loop stored in rekordbox can be played back as the active loop.

The set active loop point is indicated with a red line on the waveform display, as shown below.



When the set point is reached, the loop is set automatically and loop playback begins.

Emergency loops

With this unit, a 4-beat loop is set automatically to prevent the sound from being interrupted if a track can no longer continue to play.

- DJ playback is restricted during emergency looping. To cancel emergency looping, load the next track.

Setting Hot Cue

When a hot cue is set, that point can be called out and played instantaneously. Up to 3 hot cues can be set per music track.

- When the quantize function is on, there may be a slight delay in operation of this function in order to synchronize the beat.

1 Touch **[PERFORM]**.

2 Touch **[HOT CUE (REC)]**.

This switches the recording mode of hot cue. **[HOT CUE (A,B,C)]** lights on to red.

3 Touch **[HOT CUE (A,B,C)]** at any position set in hot cue during playback or pause.

The touched position is set to the hot cue and **[HOT CUE (A,B,C)]** starts flashing.

- During loop playback, the loop is registered as a hot cue. The direction of playback is not recorded for hot cues. While the hot cue is being recorded, it is not possible to record other hot cues, to set cue points, to scan in the forward or reverse direction or to scratch.
- When a hot cue is set during scratch play, playback may stop temporarily.

4 Touch **[HOT CUE (REC)]**.

This cancels the recording mode of the hot cue and returns to the playback mode.

Playing hot cues

About the color of **HOT CUE (A,B,C)**

Light color	Contents recorded as hot cue
Green	Cue Point
Orange	Loop
Not lit	Nothing is recorded.

1 Touch **[PERFORM]**.

2 This switches to the hot cue playback mode.

When the mode is in the recording mode of the hot cue, touch **[HOT CUE(REC)]**. When the mode is in the call out mode of the hot cue, touch **[HOT CUE(CALL)]**.

3 Touch any **[HOT CUE (A,B,C)]** during playback or pause.

The stored hot cue is called out and playback starts.

- The information of the loop play stored in **[HOT CUE (A,B,C)]** is different from the loop playback set using **[IN/4BEAT (IN ADJUST)]** or **[OUT (OUT ADJUST)]** button.
- It is possible to cancel loop playback using the **[RELOOP/EXIT]** button after calling out the loop stored in **[HOT CUE (A,B,C)]** and fine tune the loop-in point using the **[IN/4BEAT (IN ADJUST)]** button or the loop-out point using the **[OUT (OUT ADJUST)]** button. After adjustment, the information stored in **[HOT CUE(A,B,C)]** is changed.

Calling out hot cues

- 1 Load the track whose hot cue you want to call out.
- 2 Touch [PERFORM].
- 3 Touch [HOT CUE (CALL)].
[HOT CUE (A,B,C)] recording the hot cue starts flashing and switches to the hot cue call out mode.
- 4 Touch the [HOT CUE (A,B,C)] which you want to call hot cue.

The hot cue is called out and [HOT CUE(A,B,C)] lights up in green or orange.

- If you don't want to call out hot cue, press [HOT CUE (CALL)] without pressing [HOT CUE (A,B,C)]. The light turns off when hot cueing is not called out.
- If the call out mode of the hot cue is canceled by mistake, touch the [HOT CUE (CALL)] again.
- rekordbox can be preset so that hot cues are called out automatically when tracks are loaded.
-  is displayed on the track list for tracks for which auto hot cue loading is set.

❖ Canceling the hot cue call out mode

Perform one of the operations below to cancel the hot cue call out mode.

- Calling out hot cues A, B and C.
- Touch [HOT CUE (CALL)].

Storing cue or loop points

1 Set Cue Point or Loop Point.

2 Touch [MEMORY (DELETE)].

 [MEMORY] is displayed on the main unit display for several seconds, then the point information is stored on the USB device. Stored cue and loop points are indicated [▼] at the top of the waveform display.

- It is also possible to select media connected to other DJ players connected by PRO DJ LINK.
- To store loop points, touch [MEMORY] during loop playback. The stored loop points are shown on the playing address display.

Calling out stored cue or loop points

1 Load the track whose cue or loop points you want to call out.

2 Touch [CUE/LOOPCALL◀] or [CUE/LOOPCALL▶].

To call a point before the currently playing position, touch [CUE/LOOPCALL◀]. To call out a point after the currently playing position, touch [CUE/LOOPCALL▶].

The track cues to the called out point and pauses.

- When multiple points are stored, a different point is called out each time the button is pressed.
- Loops set as active loops can also be called out as stored loops by rekordbox.

3 Touch [PLAY/PAUSE▶/II].

Normal or loop playback starts from the point that was called out.

Deleting stored cue or loop points

- 1 Load the track containing the cue point or loop points you want to delete.
- 2 Touch [CUE/LOOPCALL◀] or [CUE/LOOPCALL▶] to call out the point to be deleted.

The track cues to the called out point and pauses.

- When multiple points are stored, a different point is called out each time the buttons [CUE/LOOP CALL ◀] or [CUE/LOOP CALL ▶] are touched.

3 Touch and hold [MEMORY (DELETE)] for over 1 second.

 [DELETE] is displayed on the main unit display, then the selected point information is deleted.

- When a stored loop set as an active loop is deleted, the active loop is also deleted.

Setting the cue point for auto cueing

The cue point to be set as the auto cue can be selected using one of the methods below.

Setting the cue point by the acoustic pressure level identified as a silent section (8 levels)

−36 dB, −42 dB, −48 dB, −54 dB, −60 dB, −66 dB, −72 dB and −78 dB

Automatically setting stored cues as cue points

The stored cue point in [MEMORY] nearest to the beginning of the track is set as the cue point for auto cueing.

- When [MEMORY] is set, [A. CUE] lights in white on the main unit display.

The setting of the cue point for auto cueing can be changed using one of the methods below.

1 Touch [MENU (UTILITY)] for over 1 second.

The [UTILITY] screen is displayed.

2 Turn the rotary selector then press it.

Select [AUTO CUE LEVEL].

3 Turn the rotary selector then press it.

Select the acoustic pressure level or [MEMORY].

Using beat jump

The playback position can be moved according to the length of the selected beat.

- If the loop is set, cancel the loop.

1 Touch [PERFORM].

2 Select the length of the beat and touch.

The playback position is moved according to the length of the selected beat.



- If the track's BPM cannot be detected, the BPM is set to 130.
- When the quantize function is on, the sound is matched to the beat, so there may be a slight delay in the function's operation.

Using loop move

The playback position of the loop can be moved according to the length of the selected beat.

- 1 **Set the loop.**
- 2 **Touch [PERFORM] during the loop playback.**
- 3 **Select the length of the beat and touch.**

The loop playback position is moved according to the length of the selected beat.



- If the track's BPM cannot be detected, the BPM is set to 130.
- When the quantize function is on, the sound is matched to the beat, so there may be a slight delay in the function's operation.

Using the slip mode

When the slip mode is turned on, normal playback in the original rhythm continues in the background while pausing (in the vinyl mode), scratching, playing loops or playing in reverse. When the slip mode is canceled, normal playback resumes from the point reached at the time the slip mode was canceled.

- When the quantize function is on, there may be a slight delay in operation of this function in order to synchronize the beat. (slip beat loop, slip reverse, slip hot cue, slip beat jump, slip loop move only)

Screen display in slip mode



- When in slip mode, [SLIP] on the screen bottom left lights up in blue.

Slip pausing

- 1 **Press the [JOG MODE VINYL] button.**
Set the jog mode to VINYL.
➡ *Switching the jog dial mode (p.18)*
- 2 **Touch [SLIP].**
The mode switches to the slip mode.
- 3 **During playback, press the [PLAY/PAUSE ►/II] button.**
Normal playback continues in the background even while in the pause mode.
- 4 **Press the [PLAY/PAUSE ►/II] button to cancel the pause mode.**
 - When the slip pause mode is canceled, normal playback of the sound that was playing in the background resumes. At this time, the value adjusted with the [VINYL SPEED ADJUST TOUCH/RELEASE] control is disabled and playback starts at the normal speed.

Slip scratching

- 1 **Press the [JOG MODE VINYL] button.**
Set the jog mode to VINYL.
➡ *Switching the jog dial mode (p.18)*
- 2 **Touch [SLIP].**
The mode switches to the slip mode.
- 3 **During playback, press the top of the jog dial.**
The scratch play mode is set.
Normal playback continues in the background even while scratching.
- 4 **Release your hand from the top of the jog dial.**
Normal playback of the sound that was playing in the background resumes.

Slip looping

- 1 **Touch [SLIP].**
The mode switches to the slip mode.
- 2 **Press the [IN/4BEAT (IN ADJUST)] button, then press the [OUT (OUT ADJUST)] button.**
Loop playback starts.
Normal playback continues in the background even during loop playback.
 - Loops of over 8 seconds cannot be set.
 - The same operation is performed when the [IN/4BEAT (IN ADJUST)] button is pressed for over 1 second and a loop is set.
- 3 **Press the [RELOOP/EXIT] button.**
Looping is canceled, and normal playback of the sound that was playing in the background resumes.

Slip loop move

Touching the length of the beat during the slip loop activates the slip loop move mode.

- 1 **Touch [SLIP].**
The mode switches to the slip mode.
- 2 **Touch [PERFORM].**
- 3 **Select and continue to touch and hold the length of the beat during the slip loop playback.**
The loop starts moving.
Normal playback continues in the background even when the slip loop move mode.
 - Depending on the length of the loop, the loop move may not be enabled.
- 4 **Release your finger.**
This cancels the slip loop move and returns to the slip loop playback before playing back the slip loop move.

Slip reverse

- 1 **Touch [SLIP].**
The mode switches to the slip mode.
- 2 **During playback, press the [DIRECTION REV] button.**
The button lights and reverse playback starts.
Normal playback continues in the background even during reverse playback.
 - Slip reverse play is automatically cancelled after 8 beats have elapsed from the position at which the [DIRECTION REV] button was pressed. Normal playback of the music playing in the background resumes.
 - If [DIRECTION REV] button is pressed again before 8 beats have elapsed, the slip reverse play is cancelled and the normal playback of the sound that was playing in the background resumes.

Slip beat jump

1 Touch [SLIP].

The mode switches to the slip mode.

2 Touch [PERFORM].

3 Select and continue to touch and hold the length of the beat.

Beat Jump starts.

Normal playback of the sound playing in the background continues during the slip beat jump.

4 Release your finger.

This cancels the slip beat jump and returns to the normal playback that was playing in the background.

Slip hot cue

1 Touch [SLIP].

The mode switches to the slip mode.

2 Touch and hold any of [HOT CUE (A,B,C)].

Hot cueing begins.

Normal playback of the sound playing in the background continues even while [HOT CUE (A,B,C)] is touched.

- At the point 4 beats after hot cueing began, the slip hot cue mode is automatically canceled and normal playback of the sound that was playing in the background resumes.

3 Release your finger from [HOT CUE (A,B,C)].

Normal playback of the sound that was playing in the background resumes on releasing your finger from [HOT CUE (A,B,C)] before 4 beats have elapsed from the starting position of the hot cue.

Canceling the slip mode

Touch [SLIP] in slip mode.

The slip mode is canceled.

- The slip mode is also cancelled when a new track is loaded.

Playing from the position on the waveform which was touched

Touch the waveform with your finger to easily play the audio starting from the position touched. Keep touching the waveform and move your finger to move to the desired position.

You can perform track search by touching the waveform only in the following conditions.

- In the pause mode
- While the jog dial is being pressed with the jog mode set to VINYL

Touch the waveform during pause.

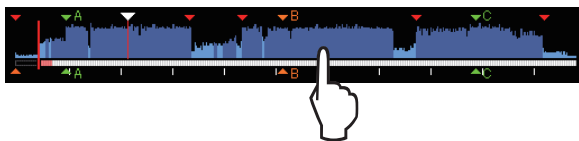

The currently playing position on the playing address display moves to the point directly above the position that was touched.

- If you move your finger quickly, the playing address display may not be shown properly.

Using the beat sync function

When beat sync is turned on, the BPM and beat position of tracks played on this unit can automatically be synchronized with the DJ player connected by PRO DJ LINK that is set as the sync master.

- The beat sync function does not operate for tracks that have not been analyzed with rekordbox.

1 Touch [BEAT SYNC MASTER] of the DJ player to use sync master.

Set the DJ player you want to be the sync master.

When the beat sync function is on, the BPM display on the DJ player set as the sync master changes to orange.

- rekordbox can also be set as the sync master.
 - For the procedure to set the rekordbox to sync master, see the rekordbox (Mac/Windows) user's manual.

2 Touch [BEAT SYNC].

The BPM and beat position of the currently playing track are synchronized to the sync master.

- During synchronization, tempo control with the tempo slider is disabled and the playing speed display switches to the tempo slider position's BPM display, displayed in gray.

Changing the DJ player set as the sync master

The sync master can be changed to another DJ player connected by PRO DJ LINK as described below.

- Change or pause the track on the DJ player set as the sync master.
- Cancels the sync master setting of the DJ player which is used as the sync master.
- Sets a DJ player which is not the Sync Master, as the Sync Master.

Canceling synchronization

Touch [BEAT SYNC].

- If the synchronized playing tempo (BPM) and the slider position's tempo (BPM) do not match, the synchronized playing tempo is maintained and tempo control with the tempo slider remains disabled. Normal operation is restored when the position of the tempo slider is moved to the synchronized playing tempo position.

Adjusting the beat grid

The enlarged waveform displays the beat grid with red lines. The beat grid can be adjusted by the following procedure.

1 Press the rotary selector for at least 1 second.

The mode switches to the [GRID ADJUST] mode.

2 When the rotary selector is turned, the beat grid is adjusted.

3 Touch [MENU (UTILITY)].

Operation below is processed by menu screen.

- [reset]: Resets the adjusted beat grid.
- [snap grid (CUE)]: Moves the first beat to the position of the currently set cue.
- [SHIFT GRID]: Reflects the results adjusted during synchronization (pitch bend, etc.) on the beat grid.

4 Press the rotary selector for at least 1 second.

Return to [ZOOM] mode.

Operating the XDJ-1000 in combination with other devices

When connected by LAN cable with a Pioneer DJ mixer, such operations as starting playback on this unit can be controlled with the DJ mixer's fader.

- Connect this unit and the Pioneer DJ mixer ahead of time. For instructions on connections, see *Connections* on page 7.
- For details on player number settings, see *Connecting to a mixer with only one LAN port* on page 7.
- Also refer to the description of the fader start function included in the Pioneer DJ mixer's operating instructions.

Starting playback using a DJ mixer's fader (Fader Start)

1 Connect this unit with the Pioneer DJ mixer using a LAN cable.

For instructions on connecting, see *Basic style* on page 7.

- If the Pioneer DJ mixer does not have a LAN port, connect a mini phone plug cable (Ø 3.5 mm) to the CONTROL terminal.

2 Turn on the DJ mixer's fader start function.

3 Set cues on this unit.

4 Move the DJ mixer's channel fader or cross fader.

This unit's pause mode is canceled and the track is played instantaneously.

- When the channel fader or cross fader is set back to its original position, playback cues back to the set cue point and the pause mode is set (Back Cue).

Relay play on two DJ players

1 Connect this unit and a DJ mixer.

For instructions on connecting, see *Connections for relay play* on page 10.

2 Set the DJ mixer's cross fader to the center position.

3 Turn auto cue on for both DJ players.

The DJ players' auto cue indicators light.

[A. CUE] lights in case of this unit.

4 Start playback on this unit.

The first track on this unit is played, and once it finished playback begins automatically on the other DJ player. This unit cues to the beginning of the next track and pauses. This operation is repeated for relay play between the two DJ players.

- Relay play may not be possible if the two DJ players are not connected to the same DJ mixer.
- If the power of one DJ player is turned off during playback, playback may start on the other DJ player.

Browsing tracks

The various devices and the rekordbox library on the connected computer can be browsed to display a list of the tracks.

- When a USB device that does not contain the rekordbox library information is browsed, the folders and tracks (music files) are displayed in a list with a tree structure.

Switching to the browse screen

Touch the touch key corresponding to the media.

This displays the list of contents of each source.

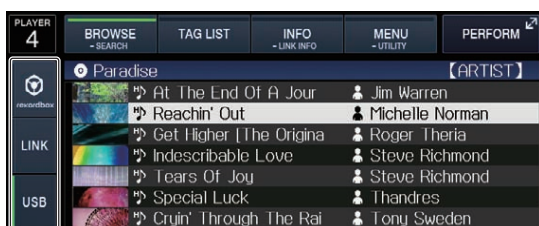

- [USB]: Displays the contents of the connected USB device and mobile devices.
- When you touch [LINK], other music files in the DJ player will be displayed.
- When you touch [rekordbox], music files in rekordbox will be displayed.
- When [BROWSE (SEARCH)] is touched while the browser screen is displayed, the browser screen closes and switches to the normal playback screen. If you touch [BROWSE (SEARCH)] again, the last browser screen opens.

❖ Description of the screen

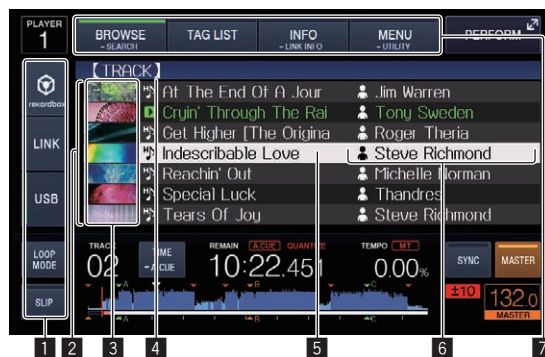

1	Media select	The indicator corresponding to the media that was pressed ([USB], [LINK], [rekordbox]), lights. The medium on which the track is loaded flashes.
2	List of contents	The contents of the selected medium are displayed.
3	Jacket photo	Part of the artwork registered in rekordbox is displayed here. When [INFO (LINK INFO)] is touched, the jacket photo turns off and the track names are displayed along the left edge. For lists of playlists and playing histories, a serial number is displayed. If there is no rekordbox library, the track names are constantly displayed along the left edge.
4	Uppermost level	Displays the name of the upper folder or media of the displayed item.
5	Cursor	Turn the rotary selector to move the cursor up and down.
6	User-set categories	The categories displayed with rekordbox can be selected. When [INFO (LINK INFO)] is touched, the details of the track selected with the cursor are displayed. If there is no rekordbox library, the details of the track selected with the cursor are displayed.
7	Mode select	The indicator corresponding to the key that was touched ([BROWSE (SEARCH)], [TAG LIST], [INFO (LINK INFO)] or [MENU (UTILITY)]), lights.

Basic operations on the browse screen

❖ Selecting items

1 Display the browse screen.

➔ *Switching to the browse screen* (p.24)

2 Turn the rotary selector to select an item.



The jump function can be used by pressing the rotary selector for over 1 second.

➔ *Searching using the jump function* (p.25)

3 Press the rotary selector to enter the item.



When there is a lower layer, that layer opens. When a menu, etc., is displayed, the selected item is entered.

When the rotary selector is pressed while the cursor is set at a track, that track is loaded in this unit.

❖ Moving back up to a higher layer

Press the [BACK] button while the browser screen is displayed.

The screen moves back to the layer above.

- When the [BACK] button is pressed for over 1 second or the media being browsed is touched, the display moves to the topmost level.
- To play a track on a USB device or a track in the rekordbox library on a computer or a mobile device, the information below can be viewed by pressing the [BACK] button at the topmost level.
 - When there is no rekordbox library information on the USB device: That medium's free space and used space
 - When there is rekordbox library information on the USB device: That medium's free space and used space, as well as the number of tracks, number of playlists and last modified dates in the library information
 - rekordbox on a computer or mobile device: The number of tracks and playlists in the library information

Other browsing operations

Rearranging tracks (Sort menu)

While browsing, the sort menu can be used to change the order of the tracks.

- This function only works in the following cases:
 - When browsing the rekordbox library on a computer or mobile device
 - When browsing the rekordbox library on a USB device

1 Display the rekordbox library.

- *Playing music files on other DJ players (p.17)*
- *Playing the rekordbox library on a computer or mobile device (p.17)*

2 When the list of the tracks is displayed, touch [MENU (UTILITY)].

The sort menu appears on the screen.

3 Use the rotary selector to select and enter the sort item.

The tracks on the list are sorted according to the selected item.

- The sort items displayed on the sort menu can be changed in the rekordbox settings. The rekordbox library on the USB device is reflected once it is re-exported after changing the settings.

Searching for tracks

- This function only works in the following cases:
 - When browsing the rekordbox library on a computer or mobile device
 - When browsing the rekordbox library on a USB device

❖ Searching using the [SEARCH] category

In the library browse mode, tracks can be search for using the [SEARCH] category.

1 Display the rekordbox library.

- *Playing music files on other DJ players (p.17)*
- *Playing the rekordbox library on a computer or mobile device (p.17)*

2 Use the rotary selector to select and enter the [SEARCH] category.

A character appears at the bottom of the main unit display.

- When you continue to touch and hold [BROWSE (SEARCH)], the [SEARCH] screen starts.

3 Input the characters using the keyboard on the touch display.

Only the tracks including the character you have input are displayed.

- When more characters are input, only the tracks including the character string you have input are displayed.
- When the [BACK] button is pressed, the category selection screen reappears.

Searching using the currently playing track's key

When the displayed category is the key display, the key icon for tracks whose keys are a good match with the currently playing track's key switches to green.

Searching using the jump function

The jump function can be used to instantaneously move to the track, category or folder you want to play.

The jump function includes the two modes below.

- Letter jumping: Use this when the tracks are arranged or sorted in alphabetical order.
- Page jumping: Use this when tracks are not in alphabetical order or are not sorted.

❖ In the letter jump mode

1 Display a list sorted in alphabetical order.

Display a list sorted in alphabetical order, such as the rekordbox library or the track list on a USB device.

2 Press the rotary selector for at least 1 second.

Switch to the letter jump mode. The first letter of the track or category selected with the cursor is enlarged.

3 Turn the rotary selector to select the character or symbol.

The cursor moves to tracks or categories starting with the selected character or symbol.

- If there are no tracks or categories starting with the selected character on the list, the cursor does not move.
The characters displayed in the letter jump mode are letters A to Z, numbers 0 to 9 and certain symbols.

❖ In the page jump mode

1 Display a list not sorted in alphabetical order.

Displays the list without sorting in alphabetical order such as folders on a USB device.

2 Press the rotary selector for at least 1 second.

The mode switches to the page jump mode.

3 Turn the rotary selector to select the page.

The display moves to the selected page.

❖ Using the information jump function

The categories to which tracks belong can be displayed by selecting items displayed in the details. This function is convenient for searching for tracks in the same genre as the loaded track, tracks with similar BPMs, etc.

1 Load a track.

2 Touch [INFO (LINK INFO)] on the normal playback screen.

The track's details are displayed.

- *Displaying the details of the currently loaded track (p.28)*

3 Select and enter the item.

The screen switches to the browse screen and the category for the selected item is displayed.

- Touch [BROWSE (SEARCH)] to close the browser screen.
- It may not be possible to select items, for example for items with nothing to be displayed on the browse screen, items for which only icons are displayed in the details, etc.
- When a track is selected, the browse screen displayed directly before the track was loaded is displayed.
- Only the tracks can be selected from a USB device if it does not contain the rekordbox library.

Checking the playing history (HISTORY)

The track playing history is stored and displayed at the [HISTORY] category on the browse screen.

- Playlists can be created based on the playing history at [HISTORY] using rekordbox. For details, see rekordbox (Mac/Windows)'s operating instructions.

Storing the playing history

1 Connect the USB device to this unit.

2 Play tracks.

Tracks that have been played for approximately 1 minute are stored on the playing history list.

- When a USB device is connected to this unit for the first time or when it is reconnected to this unit, a new playing history is automatically created on the USB device.
- The names of playing history lists can be preset at [UTILITY].
 ↪ *Setting the playing history list name* (p.30)
- When the same track is played two or more times consecutively, it may not be stored in the history.
- The maximum number of tracks that can be stored on a playing history list is 999. From the 1 000th track on, the oldest entries on the playing history are deleted to make room for the new entries. Up to 999 playing history lists can be created.
- When tracks are registered on the playing history list, their track names, etc., are displayed in green (indicating that they have been played).
- Track names etc. of the tracks at the [PLAYLIST] category can be changed to green (played) using [MENU (UTILITY)]. When changed, the tracks are registered on the playing history list.

Deleting the playback history

1 Connect the USB device to this unit.

2 Display the rekordbox library.

- ↪ *Playing music files on other DJ players* (p.17)
- ↪ *Playing the rekordbox library on a computer or mobile device* (p.17)

3 Use the rotary selector to select and enter the [HISTORY] category.

A list of the playing history lists is displayed.

4 Turn the rotary selector and select the playing history list to be deleted.

5 Touch [MENU (UTILITY)].

The remove menu is displayed.

6 Turn the rotary selector to select and enter the range to be deleted.

- [DELETE]: The currently selected playing history list is deleted.
- [ALL DELETE]: All the playing history lists are deleted.
- When a USB device's playing history is loaded as a rekordbox playlist, the previously loaded playing history is deleted from the USB device.
- For tracks in the [PLAYLIST] category, the tracks can be changed from green (played) to white (not played) using [MENU (UTILITY)]. When this change is made, the tracks are deleted from the playing history list.

7 Use the rotary selector to select and enter [OK].

Editing tag lists

Tracks to be played next or tracks selected according to DJ situations can be marked and collected on lists. The list of collected tracks is called the "tag list". These tag lists can be shared in real time among multiple DJ players connected by PRO DJ LINK.

- Up to 100 tracks per device can be added to a tag list.
- One tag list can be created per USB device. It is not possible to make a tag list containing tracks on different USB devices.
- It is not possible to register the same track in the same folder twice.



1	List of contents	The contents of the tag list are displayed here.
2	Medium name	The name of the medium on which the track is recorded is displayed here.
3	Jacket photo	Part of the artwork registered in rekordbox is displayed here. On touching [INFO (LINK INFO)], the jacket photo turns off and sequential number are displayed.
4	Cursor	Turn the rotary selector to move the cursor up and down.
5	User-set categories	The categories displayed with rekordbox can be selected. When [INFO (LINK INFO)] is touched, the details of the track selected with the cursor are displayed.

Adding tracks to the tag list

❖ Selecting tracks and adding them

1 Switch to the browse screen and display the list of tracks.

2 Set the cursor to the track and press the [TAG TRACK/REMOVE] button.

☑ is displayed to the left of the track and the track is added to that medium's tag list.

- Tracks can be recorded in the tag list ahead of time using rekordbox.
 — For detailed operating procedure, see the rekordbox (Mac/Windows) user's manual.

❖ Adding loaded tracks

1 Load a track.

2 Press the [TAG TRACK/REMOVE] button.

The track loaded in this unit is added to the tag list.

❖ Adding entire categories or folders

All the tracks in a selected category or folder can be added to the tag list.

1 Switch to the browse screen and select a category or folder that has tracks directly under it.

A list of the tracks is displayed on the right half of the information display screen.

2 Set the cursor to the category or folder, then press the [TAG TRACK/REMOVE] button.

The category or folder name flashes, and all the tracks in that category or folder are added to the tag list.

- When folders are added while in the folder browse mode, tracks for which ID3 tags, etc., have not been loaded a single time are registered using the file name as the track name. The artist names are not registered.
- After tracks have been added to the tag list, when the registered tracks are displayed on the track list on the browse screen or are loaded in a player and their ID3 tags, etc., are loaded, the file names switch to the track names and the artist names are also registered.

❖ Adding tracks from playlists

All the tracks on a selected playlist can be added to the tag list.

1 Switch to the browse screen and select and enter the [PLAYLIST] category.

A list of the playlists is displayed, and a list of the tracks is displayed on the right half of the information display screen.

2 Set the cursor to the play list, and press the [TAG TRACK/REMOVE] button.

The playlist name flashes, and all the tracks on that playlist are added to the tag list.

Loading tracks from the tag list

1 Touch [TAG LIST].

The tag list is displayed.

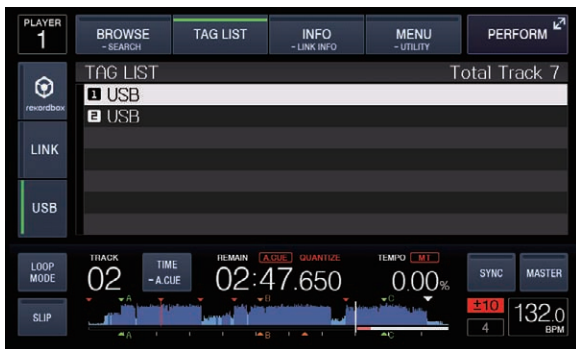

- When multiple mediums are connected to a DJ player, the player number of the player to which that medium is connected and the rekordbox icon are displayed in front of the medium's name.

2 Use the rotary selector to select and enter the medium.

When a medium is selected, that medium's tag list is displayed.

3 Use the rotary selector to select and enter the track you want to load.

The track is loaded and playback starts.

Removing tracks from the tag list

Tracks can be removed from tag lists.

- If a track that has been added to the tag list is removed from the tag list while it is playing, the track is played to the end, then the stop mode is set. The next track is not played.

❖ Removing one track at a time

1 Touch [TAG LIST].

The tag list is displayed.

2 Use the rotary selector to select and enter the medium.

When a medium is selected, that medium's tag list is displayed.

3 Use the rotary selector to set the cursor to the track you want to remove.

4 Press the [TAG TRACK/REMOVE] button for over 1 second.

Tracks can be removed from tag lists by pressing the [TAG TRACK/REMOVE] button at the screens and situations described below.

- When the cursor is set to a track registered in the tag list on the browse screen
- When the normal playback screen or a track's details screen is displayed while a track registered in the tag list is loaded

❖ Removing all the tracks

1 Touch [TAG LIST].

The tag list is displayed.

2 Use the rotary selector to select and enter the medium.

When a medium is selected, that medium's tag list is displayed.

3 Touch [MENU (UTILITY)].

[LIST MENU] is displayed.

4 Use the rotary selector to select and enter [TAGLIST MENU].

[TAGLIST MENU] is displayed.

5 Use the rotary selector to select and enter [REMOVE ALL TRACKS].

6 Use the rotary selector to select and enter [OK].

Transforming the tag list into a playlist

Tracks collected in tag lists can be converted into playlists.

- Converted playlists are displayed as items in the [PLAYLIST] category.

1 Touch [TAG LIST].

The tag list is displayed.

2 Use the rotary selector to select and enter the medium.

When a medium is selected, that medium's tag list is displayed.

3 Touch [MENU (UTILITY)].

[LIST MENU] is displayed.

4 Use the rotary selector to select and enter [TAGLIST MENU].

[TAGLIST MENU] is displayed.

5 Use the rotary selector to select and enter [CREATE PLAYLIST].

6 Use the rotary selector to select and enter [OK].

The contents of the tag list are converted into a playlist with the name [TAG LIST XXX].

- If no rekordbox library information is stored on the medium, the tag list cannot be converted into a playlist.
- When tag lists include both tracks being managed with rekordbox and tracks not being managed with rekordbox, only the tracks being managed with rekordbox are converted into playlists.

Displaying the details of the currently loaded track

The details of the currently loaded track can be checked.

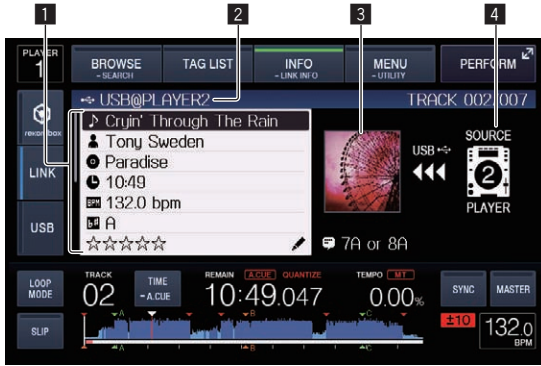

1	Track details	The details of the tracks loaded in the DJ player are displayed here.
2	Medium/player number	The place where the track information is stored is displayed here.
3	Jacket photo and comment	The jacket photo and comment about the track loaded in the DJ player are displayed here.
4	Source indicator	This indicates the location of the currently loaded track.

The source indicator (4) is not displayed when the media inserted in this unit is loaded.

1 Load a track.

2 Touch [INFO (LINK INFO)] on the normal playback screen.

The track's details are displayed.

Changing track ratings

The tracks' ratings can be changed.

1 Load a track.

2 Touch [INFO (LINK INFO)] on the normal playback screen.

The track's details are displayed.

3 Select the rating displayed in the detailed information (display example: ☆☆☆☆☆).

4 Press the rotary selector for over 1 second, then turn the rotary selector clockwise or counterclockwise.

The rating of the loaded track is changed.

5 Press the rotary selector and enter the rating.

Displaying details of tracks loaded in other DJ players



When another DJ player is connected by PRO DJ LINK, the details of the track loaded on the other DJ player can be checked.

1 Connect this unit and the other DJ players by PRO DJ LINK.

2 Touch [INFO (LINK INFO)] for over 1 second.

The [LINK INFO] screen appears.

3 Use the rotary selector to select and enter the DJ player whose track details you want to see.

The details of the tracks loaded in the selected DJ player are displayed.

Changing the settings

Storing settings on USB devices

The [UTILITY] settings and other settings can be stored on USB devices. The stored settings can be exported to rekordbox.

It is also possible to store this unit's settings on USB devices after making them with rekordbox then load these settings onto another player.

- The stored settings are shown below.
 - [UTILITY] settings
PLAY MODE, LOAD LOCK, AUTO CUE LEVEL, SLIP FLASHING, ON AIR DISPLAY, LANGUAGE, LCD BRIGHTNESS
 - Other settings
TIME MODE (how the time is displayed on the main unit display),
AUTO CUE, JOG MODE, TEMPO RANGE, MASTER TEMPO,
QUANTIZE, BEAT SYNC

1 Connect the USB device onto which you want to store the settings.

2 Touch [USB].

If the USB device onto which the settings are to be stored is connected to another PRO DJ LINK connected DJ player, touch [LINK] to select the storage device.

3 Touch [MENU (UTILITY)].

4 Use the rotary selector to select and enter [SAVE] at [MY SETTINGS].

The settings are stored.

Calling out settings stored on a USB device

[UTILITY] settings and other settings stored on a USB device can be called out.

1 Sets the USB device for calling out the setting details.

2 Touch [USB].

If the USB device onto which the settings are to be stored is connected to another PRO DJ LINK connected DJ player, touch [LINK] to select the recording medium.

3 Touch [MENU (UTILITY)].

4 Use the rotary selector to select and enter [LOAD] at [MY SETTINGS].

The settings are called out.

Changing the color set in the USB

When a USB device is set to this unit, the USB indicator or part of the screen display can be lit in the set color and can be flashed.

- It lights, flashes when this unit is communicating with the USB device.
- Only for the USB device with an audio file or management data exported from rekordbox, [BACKGROUND COLOR] is displayed.

1 Sets the USB device for changing the color of the USB indicator.

2 Touch [USB].

3 Touch [MENU (UTILITY)].

4 Turn the rotary selector to select [BACKGROUND COLOR] of [MY SETTINGS].

5 Use the rotary selector to choose and decide the color to be set.

Displaying the [UTILITY] screen

Touch [MENU (UTILITY)] for over 1 second.

The [UTILITY] screen is displayed.

Description of the screen

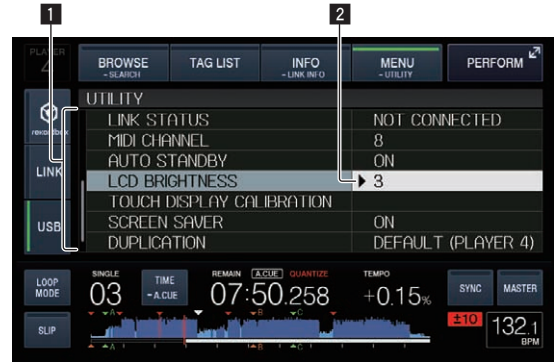

- 1** Options settings This unit's settings items are displayed here.
- 2** Setting The settings for the various items are displayed here.

Changing the settings

1 Touch [MENU (UTILITY)] for over 1 second.

The [UTILITY] screen is displayed.

2 Use the rotary selector to select the setting item.

3 Set the cursor to the item you want to change, then press the rotary selector.

The cursor moves to the setting.

4 Turn the rotary selector and change the setting.

5 Press the rotary selector to enter the setting.

The cursor returns to the setting.

- When the [BACK] button is pressed before entering the setting, the change is aborted.

6 Touch [MENU (UTILITY)].

Returns to the last screen before [MENU (UTILITY)] was touched.

Setting preferences

Options settings	Setting ranges	Descriptions
PLAY MODE	CONTINUE*/SINGLE	Changes the way the tracks loaded in this unit are played. For details, see <i>Changing the play mode</i> on page 30.
LOAD LOCK	LOCK/UNLOCK*	Sets whether to disable or enable loading of new tracks during playback.
AUTO CUE LEVEL	-36 dB/-42 dB/ -48 dB/-54 dB/-60 dB/ -66 dB/-72 dB/-78 dB/ MEMORY*	For details, see <i>Setting the cue point for auto cueing</i> on page 21.
SLIP FLASHING	ON*/OFF	Sets whether or not the indicators of buttons, etc., for which the slip function is activated should flash when [SLIP] is touched.

Options settings	Setting ranges	Descriptions
ON AIR DISPLAY	ON*/OFF	Sets whether or not to display the tracks' ON AIR status on the main unit display. When connected by PRO DJ LINK to a mixer supporting the ON AIR DISPLAY function (e.g. DJM-2000nexus), it is possible to display the ON AIR status in association with the operation of the mixer's channel fader and crossfader. Also see the operating instructions of the mixer supporting the ON AIR DISPLAY function.
LANGUAGE	—	Sets the main unit display's language.
HISTORY NAME	—	For details, see <i>Setting the playing history list name</i> on page 30.
PLAYER No.	AUTO*, 1 – 4	Sets this unit's player number. The player number cannot be changed when a medium is loaded in this unit.
LINK STATUS	—	When PRO DJ LINK connections are made, the connection status is displayed here.
MIDI CHANNEL	1* to 16	For details, see <i>Changing the MIDI channel setting</i> on page 32.
AUTO STANDBY	ON*/OFF	For details, see <i>Setting the auto standby mode</i> on page 30.
LCD BRIGHTNESS	1 – 3* – 5	Sets the main unit display's brightness.
TOUCH DISPLAY CALIBRATION	—	For details, see <i>Correct the alignment of touch display</i> on page 30.
SCREEN SAVER	ON*/OFF	When set to [ON], the screensaver starts up in the following cases: <ul style="list-style-type: none"> When no track is loaded in this unit for over 5 minutes When no operation is performed for over 100 minutes while in the pause or cue standby mode or when [END] is displayed on the main unit display.
DUPLICATION	DEFAULT*, ALL, PLAYER1-4	For details, see <i>Duplicating the settings onto DJ players connected by PRO DJ LINK</i> on page 31.
VERSION No.	—	Displays this unit's software version.

*: Setting upon purchase

Changing the play mode

1 Display the [UTILITY] screen.

☞ *Displaying the [UTILITY] screen* (p.29)

2 Use the rotary selector to select and enter [PLAY MODE].

3 Use the rotary selector to select and enter [CONTINUE] or [SINGLE].

CONTINUE: Moving to the previous or following track is possible in all modes.

SINGLE: The letters [TRACK] on the main unit display switch to [SINGLE] and it is no longer possible to move to the previous or following track other than with the track search and search buttons.

Setting the auto standby mode

1 Display the [UTILITY] screen.

☞ *Displaying the [UTILITY] screen* (p.29)

2 Use the rotary selector to select and enter [AUTO STANDBY].

3 Use the rotary selector to select and enter [ON] or [OFF].

When [AUTO STANDBY] is set to [ON], the auto standby function is activated and the standby mode is set in the cases described below.

- When absolutely no operation is performed for over 4 hours with no USB device connected, no PRO DJ LINK connections or computer connected to the **USB** terminal (on this unit's rear panel).
- When this unit is operated, the standby mode is canceled.
- This unit is shipped with the auto standby function turned on. If you do not want to use the auto standby function, set [AUTO STANDBY] to [OFF].

Setting the playing history list name

Names of playing history stored on USB devices can be preset.

1 Display the [UTILITY] screen.

☞ *Displaying the [UTILITY] screen* (p.29)

2 Use the rotary selector to select and enter [HISTORY NAME].

3 Input the characters using the keyboard shown on the touch display.

4 Press the rotary selector to enter.

The name is changed to the name you have input.

- When the name of the playing history list is changed, the number after the playing history list name returns to 001. This number is incremented each time a playing history list is created.
- The maximum number of characters that can be set for the [HISTORY] name is 32, including both letters, numbers and symbols.

Changing the language

Select the language to be used for displaying track names and messages on the screen.

- When the language is changed, the messages on the main unit display are displayed in the selected language.
- When displaying track names, etc., to display characters written in local codes other than Unicode, change the [LANGUAGE] setting.

1 Display the [UTILITY] screen.

☞ *Displaying the [UTILITY] screen* (p.29)

2 Use the rotary selector to select and enter [LANGUAGE].

3 Use the rotary selector to select and enter the language.

The language of the on-screen display is changed.

Correct the alignment of touch display

1 Display the [UTILITY] screen.

☞ *Displaying the [UTILITY] screen* (p.29)

2 Use the rotary selector to select and enter [TOUCH DISPLAY CALIBRATION].

3 Touch [+] displayed on the screen, in order.

Touch 16 places in all.

4 Press the rotary selector to enter.

The changed settings are stored.

- This unit has been shipped after calibration. Set the calibration if you cannot touch properly.
- When setting the calibration, do not use a pointed object like a ball-pen.

Duplicating the settings onto DJ players connected by PRO DJ LINK

The [UTILITY] settings and other settings can be duplicated onto DJ players connected by PRO DJ LINK.

- The duplicated settings are as shown below.
 - [UTILITY] settings
PLAY MODE, LOAD LOCK, AUTO CUE LEVEL, SLIP FLASHING, ON AIR DISPLAY, LANGUAGE, LCD BRIGHTNESS
 - Other settings
TIME MODE (how the time is displayed on the main unit display), AUTO CUE, JOG MODE, TEMPO RANGE, MASTER TEMPO, QUANTIZE, BEAT SYNC

1 Select [DUPLICATION] and enter.

2 Stop playback on the DJ player(s) on which you want to reflect the settings.

3 Use the rotary selector to select and enter [PLAYER X] or [ALL].

[PLAYER1]–[PLAYER4]: The settings are duplicated on the specified DJ player. Currently playing DJ players cannot be selected.

[ALL]: The settings are duplicated on all the DJ players connected by PRO DJ LINK. The settings cannot be duplicated on currently playing DJ players.

[DUPLICATED] is displayed on the specified player's display and this unit's [UTILITY] settings and other settings are duplicated on the specified player.

[DEFAULT]: Restores this unit's settings to the settings set upon purchase.

Installing the driver software

About the driver software (Windows)

This driver software is an exclusive ASIO driver for outputting audio signals from the computer.

- There is no need to install the driver software when using Mac OS X.

❖ Obtaining the driver software

1 Launch a web browser on the computer and access the Pioneer DJ support site below.

<http://pioneerdj.com/support/>

2 Click [Software Download] under [XDJ-1000] on the Pioneer DJ support site.

3 Click the icon of the driver software to download the driver software from the download page.

- For information on installing the driver software, see the Pioneer DJ support site.

Connecting this unit and a computer by USB

1 Connect this unit to your computer via a USB cable.

For instructions on connecting, see *Using other brands of DJ software* on page 10.

2 Press the [⏻] switch.

Turn on the power of this unit.

- The message [Installing device driver software] may appear when this unit is first connected to the computer or when it is connected to a different USB port on the computer. Wait a while until the message [Your devices are ready for use] appears.

Adjusting the buffer size (Windows)

This unit functions as an audio device conforming to the ASIO standards.

- If an application using this unit as the default audio device (DJ software, etc.) is running, quit that application before adjusting the buffer size.

Click the Windows [Start] menu>[All Programs]>[Pioneer]>[CDJXDJ]>[Pioneer CDJXDJ ASIO Settings Utility].

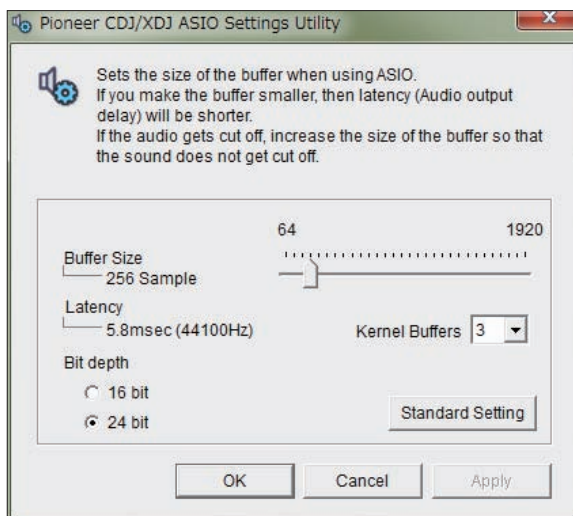

- If the buffer size is made large, drops in audio data (breaks in the sound) occur less easily, but the time lag due to the delay in the transfer of the audio data (latency) increases.
- For the bit number, specify the bit depth during ASIO playback.
- Operate referring to the procedure below to adjust the buffer size and kernel buffer.

❖ If there are no interruptions in the sound with the default settings

1 Gradually decrease the buffer size, setting it to the minimum value at which there are no interruptions in the sound.

2 Set the kernel buffer size to [2] and check whether there are interruptions in the sound.

- If there are interruptions in the sound, set the kernel buffer size to [3].

❖ If there are interruptions in the sound with the default settings

Set the kernel buffer size to [4], then set the buffer size to the minimum value at which there are no interruptions in the sound.

Checking the version of the driver software

- You can check the firmware version of this unit on the screen.

Click the Windows [Start] menu>[All Programs]>[Pioneer]>[CDJXDJ]>[CDJXDJ Version Display Utility].

- The firmware version is not displayed when this unit is not connected to the computer or when this unit and computer are not properly communicating.

Using other brands of DJ software

Operating DJ software by MIDI interface

This unit also outputs the operating data for the buttons and controls in MIDI format. If you connect a computer with a built-in MIDI-compatible DJ software via a USB cable, you can operate the DJ software on this unit. The sound of music files being played on the computer can also be output from the XDJ-1000.

To use this unit as an audio device, install the driver software on the computer beforehand (page 31). This unit must also be selected in the DJ software's audio output device settings. For details, see your DJ software's operating instructions.

1 Connect the USB port on this unit to your computer.

For instructions on connecting, see *Using other brands of DJ software* on page 10.

2 Touch [BROWSE (SEARCH)], and then touch [LINK].

[CONTROL MODE] and [USB MIDI] are displayed on menu screen.

3 Select [CONTROL MODE] and enter.

The connecting screen is displayed.

4 Select [USB MIDI] and enter.

This unit switches to the control mode.

5 Launch the DJ software.

Communication with the DJ software starts.

- The DJ software on the computer can be operated using the buttons and rotary selector on this unit.
- It may not be possible to use some buttons to operate the DJ software.
- The control mode is canceled when a track is loaded in this unit.
- For messages output by this unit, see *List of MIDI Messages* on page 32.

Changing the MIDI channel setting

1 Touch [MENU (UTILITY)] for over 1 second.

The [UTILITY] screen is displayed.

2 Select [MIDI CHANNEL] and enter.

3 Turn the rotary selector.

Select the MIDI channel and change the setting. A setting from 1 – 16 can be selected.

4 Press the rotary selector to enter.

5 Touch [MENU (UTILITY)].

The previous screen reappears.

List of MIDI Messages

SW Name	SW Type	MIDI Messages			Notes
		MSB			
JOG (TOUCH)	—	Bn	10	dd	A linear value corresponding to the speed, from stop to 4X: 64 for stop, 65 (0.06X) – 127 (4X) in the forward direction, 63 (0.06X) – 0 (4X) in the reverse direction.
TEMPO SLIDER	VR	Bn	1D	dd	0 – 127, 0 on the – side, 127 on the + side
TOUCH/RELEASE	VR	Bn	1E	dd	0 – 127, 0 (min.) on the left side, 127 (max.) on the right side
JOG RING	—	Bn	30	dd	A linear value corresponding to the speed from 0.5X to 4X: 64 when stopped (under 0.49X), 65 (0.5X) to 127 (4X) in the forward direction, 63 (0.5X) to 0 (4X) in the reverse direction.
ENCODER	General Purpose Controller	Bn	4F	dd	98 – 127, 1 – 30 Difference of count from previous time is sent ($\pm 1 - \pm 30$) When over ± 30 , set at ± 30
PLAY/PAUSE	SW	9n	00	dd	OFF=0, ON=127
CUE	SW	9n	01	dd	OFF=0, ON=127
SEARCH FWD	SW	9n	02	dd	OFF=0, ON=127
SEARCH REV	SW	9n	03	dd	OFF=0, ON=127
TRACK SEARCH NEXT	SW	9n	04	dd	OFF=0, ON=127
TRACK SEARCH REV	SW	9n	05	dd	OFF=0, ON=127
LOOP IN	SW	9n	06	dd	OFF=0, ON=127
LOOP OUT	SW	9n	07	dd	OFF=0, ON=127
RELOOP	SW	9n	08	dd	OFF=0, ON=127
QUANTIZE	GUI button	9n	09	dd	OFF=0, ON=127
MEMORY	GUI button	9n	0A	dd	OFF=0, ON=127
CALL NEXT	GUI button	9n	0B	dd	OFF=0, ON=127
CALL PREV	GUI button	9n	0C	dd	OFF=0, ON=127
DELETE	GUI button	9n	0D	dd	OFF=0, ON=127
TIME/A.CUE	GUI button	9n	0E	dd	OFF=0, ON=127
TEMPO RANGE	SW	9n	10	dd	OFF=0, ON=127
MASTER TEMPO	SW	9n	11	dd	OFF=0, ON=127
JOG MODE	SW	9n	12	dd	OFF=0, ON=127
HOT CUE A	GUI button	9n	18	dd	OFF=0, ON=127
HOT CUE B	GUI button	9n	19	dd	OFF=0, ON=127
HOT CUE C	GUI button	9n	1A	dd	OFF=0, ON=127
HOT CUE REC	GUI button	9n	1C	dd	OFF=0, ON=127
HOT CUE CALL	GUI button	9n	1D	dd	OFF=0, ON=127
MASTER SYNC	GUI button	9n	1E	dd	OFF=0, ON=127
SYNC	GUI button	9n	1F	dd	OFF=0, ON=127
JOG TOUCH	SW	9n	20	dd	OFF=0, ON=127
REVERSE	SW	9n	21	dd	OFF=0, ON=127
BEAT LOOP 1/2	GUI button	9n	27	dd	OFF=0, ON=127

SW Name	SW Type	MIDI Messages			Notes
		9n	MSB	dd	
BEAT LOOP 1	GUI button	9n	28	dd	OFF=0, ON=127
BEAT LOOP 2	GUI button	9n	29	dd	OFF=0, ON=127
BEAT LOOP 4	GUI button	9n	2A	dd	OFF=0, ON=127
BEAT LOOP 8	GUI button	9n	2B	dd	OFF=0, ON=127
BEAT LOOP 16	GUI button	9n	2C	dd	OFF=0, ON=127
SLIP	GUI button	9n	2D	dd	OFF=0, ON=127
TAG TRACK	SW	9n	30	dd	OFF=0, ON=127
BACK	SW	9n	32	dd	OFF=0, ON=127
ENCODER PUSH	SW	9n	33	dd	OFF=0, ON=127
JUMP/SHIFT 1 FWD	GUI button	9n	38	dd	OFF=0, ON=127
JUMP/SHIFT 2 FWD	GUI button	9n	39	dd	OFF=0, ON=127
JUMP/SHIFT 4 FWD	GUI button	9n	3A	dd	OFF=0, ON=127
JUMP/SHIFT 1 REV	GUI button	9n	3B	dd	OFF=0, ON=127
JUMP/SHIFT 2 REV	GUI button	9n	3C	dd	OFF=0, ON=127
JUMP/SHIFT 4 REV	GUI button	9n	3D	dd	OFF=0, ON=127
NEEDLE	GUI	Bn	1C	dd	OFF = 0 1 to 127 position data from left to right side

n is the channel number.

Additional information

Troubleshooting

- Incorrect operation is often mistaken for trouble or malfunction. If you think that there is something wrong with this component, check the points below and the **[FAQ]** for the **[XDJ-1000]** on the Pioneer DJ support site. <http://pioneerdj.com/support/>
Sometimes the problem may lie in another component. Inspect the other components and electrical appliances being used. If the problem cannot be rectified, ask your nearest Pioneer authorized service center or your dealer to carry out repair work.
- This unit may not operate properly due to static electricity or other external influences. In this case, proper operation may be restored by turning the power off, waiting 1 minute, then turning the power back on.

Problem	Check	Remedy
File cannot be played.	Is the file copyright-protected (by DRM)?	Copyright-protected files cannot be played.
No sound is produced, or sound is distorted or noisy.	Are you operating the connected DJ mixer properly?	Check the operation of the DJ mixer.
	Is this unit placed near a TV?	Turn the TV's power off or install this unit and TV away from each other.
File information is not properly displayed.	Is [LANGUAGE] properly set?	Set [LANGUAGE] to the proper language.
	Is the information recorded in a language not supported by this unit?	When creating files using DJ software, etc., record the information in a language supported by this unit.
Track search operation takes too long.	Is the auto cue function activated?	Track searching may take some time when there are long silent sections between tracks.
	—	If track searching is not possible within 10 seconds, a cue point is set at the beginning of the track.
Back cue function does not work.	Is a cue point set?	Set the cue point (page 19).
Loop play function does not work.	Are loop points set?	Set loop points (page 19).
Settings are not stored in the memory.	Has the power been turned off directly after changing the setting?	After changing settings, wait at least 10 seconds before turning the power off.
USB device is not recognized.	Is the USB device properly connected?	Connect the device securely (all the way in).
	Is the USB device connected via a USB hub?	USB hubs cannot be used.
	Is the USB device supported by this unit?	This player only supports USB mass storage class devices. This player supports portable flash memory and digital audio playback devices.
	Is the file format supported by this unit?	Check the file format of the connected USB device. For the file formats supported by this unit, see <i>Usable media</i> on page 5.
	—	Turn the power off then back on.
Cue points or loops are not stored on a USB device.	Are you trying to store more points than the limit?	Ten cue points or loop points per track can be stored on a USB device. If you try to store more points than the limit, [CUE/LOOPPOINT FULL] is displayed and the points cannot be stored. In this case, delete some points before storing new ones.
	Is the USB device write-protected?	If the USB device is write-protected, [USB FULL] is displayed and the points cannot be stored. Disable the write-protection then store the cue or loop points again.
	Is there sufficient free space on the USB device?	If there is not enough free space on the USB device, [USB FULL] is displayed and the points cannot be stored. Free up some space then store the cue or loop points again.
Cue or loop points of tracks recorded on USB devices are not displayed.	Was the USB device properly stopped before it was disconnected the last time?	The contents might not be displayed if the device is removed without stopping it or if the unit is turned off. Check that the USB indicator has turned completely off before disconnecting the USB device and turning this unit's power off.
Playback does not start immediately after pressing the button to reloop or play in reverse.	Is the quantize function on?	When the quantize function is on, playback starts from the nearest beat position at the time the button is pressed. If you want the operation to be performed the instant the button is pressed, turn the quantize function off.
The playing address display is not displayed in the remaining time mode.	—	When playing files recorded in VBR, it may happen that the set cannot detect the length of the track immediately and that some time is required for the playing address display to appear.
Time is required to read USB devices (flash memory drives and hard discs).	Is there a large number of folders or files recorded on the USB device?	When there are many folders or files, some time may be required for loading.
	Are files other than music files stored on the USB device?	When files other than music files are stored in folders, time is required to read them as well. Do not store files or folders other than music files on the USB device.
Library browsing is not possible.	Is a medium on which library information is recorded loaded?	The library browse mode is only set when media on which library information is recorded are loaded. When a medium on which no library information is recorded is loaded, the folder browse mode is set.
[HISTORY] is not displayed.	Is a USB device loaded?	The [HISTORY] function can only be used for DJ players on which a USB device is loaded.
Nothing is displayed.	Is the auto standby function activated?	This unit is shipped with the auto standby function set to on. If you do not want to use the auto standby function, set [AUTO STANDBY] on the [UTILITY] menu to [OFF] . (page 30)

Problem	Check	Remedy
The scale is not displayed.	Is the track over 15 minutes long?	The scale is not displayed for tracks whose playing time is over 15 minutes. (page 14)
PRO DJ LINK does not work well.	Are the player numbers properly set?	Set [PLAYER No.] to [AUTO] or to a number different from the number currently set. (page 29)
	Is the LAN cable properly connected?	Connect the LAN cable properly to the [LINK] terminal.
	Is the switching hub's power turned on?	Turn the switching hub's power on.
	Is an unnecessary device connected to the switching hub?	Disconnect the unnecessary device from the switching hub.
There is no response when you touch the screen, or the response is bad. A position different from the actually touched location responds.	Calibration adjustment of touch display is deviating.	Adjust the touch display by using the [TOUCH DISPLAY CALIBRATION] settings in the [UTILITY] screen. When the power is OFF, users can view the [TOUCH DISPLAY CALIBRATION] settings screen by switching the power ON while keeping the [OUT(OUT ADJUST)] button pressed.

About the liquid crystal display

- Small black or shining points may appear on the liquid crystal display. This is a phenomenon inherent to liquid crystal displays; this is not a malfunction.
- When using in cold places, the liquid crystal display may be dark for a while after this unit's power is turned on. It will reach the normal brightness after a while.
- When the liquid crystal display is exposed to direct sunlight, the light will reflect off it, making it difficult to see. Block the direct sunlight.

Error messages

































When this unit cannot operate normally, an error code appears on the display. Check the table below and take the measures indicated. If an error code not shown on the table below is displayed, or if the same error code is displayed again after taking the indicated action, contact your store of purchase or a nearby Pioneer service station.

Error code	Error type	Description of error	Cause and action
E-8302	CANNOT PLAY TRACK(****)	Track data (files) in the USB cannot be read correctly.	The track data (file) may be corrupt. → Check whether the track (file) can be played on another player, etc., capable of playing the same formats as this unit.
E-8304 E-8305	UNSUPPORTED FILE FORMAT	Music files that cannot be played normally are loaded.	Format is wrong. → Replace with music files in the proper format.

Cleaning the touch display

Do not use organic solvents, acids or alkalis for cleaning the surface of the touch display. Wipe with a dry soft cloth or a cloth immersed in neutral detergent and squeezed properly.

List of icons displayed on the main unit display section

 Genre	 Player number (1 – 4)	 Computer	 Close folder	 WAIT
 Artist	 Edit the rating	 Year	 Remixer	 rekordbox
 Album	 Registered in tag list	 Label	 Original artist	 Mixer
 Track/file name	 Tempo (BPM)	 Key	 Search	 Hot cue
 Playlist HISTORY Hot Cue Bank List	 Color	 Bit rate	 DJ play count	
 Rating	 USB	 Playing	 Date library added	
 Time	 SD	 Open folder	 Comment	

About iPod/iPhone

- This product has been developed and tested based on the iPod/iPhone software versions indicated on the Pioneer support DJ site. (<http://pioneerdj.com/support/>)
- Compatibility with this product may be lost if a version other than the one indicated on the Pioneer support DJ site is installed on your iPod/iPhone.
- Note that Pioneer does not offer any guarantee regarding the operation of iPod/iPhone.
- Pioneer will accept no responsibility whatsoever for any loss of data on iPod/iPhone during use.
- With iPod/iPhone, material that is not copyrighted or the material for which duplication and playback is legally permitted may be duplicated and played by individuals on a private basis. Infringement of copyrights is prohibited by law.

Trademarks, licenses, etc.

- Pioneer rekordbox, and KUVO are trademarks or registered trademarks of the PIONEER CORPORATION.
- Windows is a registered trademark of Microsoft Corporation in the United States and other countries.
- Adobe and Reader are either registered trademarks or trademarks of Adobe Systems Incorporated in the United States and/or other countries.
- ASIO is a trademark of Steinberg Media Technologies GmbH.
- "Made for iPod" and "Made for iPhone" mean that an electronic accessory has been designed to connect specifically to iPod or iPhone, respectively, and has been certified by the developer to meet Apple performance standards. Apple is not responsible for the operation of this device or its compliance with safety and regulatory standards. Please note that the use of this accessory with iPod or iPhone may affect wireless performance.



- iPhone, iPod, iPod touch, Mac, and Mac OS are trademarks of Apple Inc., registered in the U.S. and other countries.
- Android™ is a trademark of Google Inc.
- iOS is a trademark on which Cisco holds the trademark right in the US and certain other countries.
- This software is based in part on the work of the Independent JPEG Group.
The software in this unit uses in part software of the Independent JPEG Group.

About using MP3 files

This product has been licensed for nonprofit use. This product has not been licensed for commercial purposes (for profit-making use), such as broadcasting (terrestrial, satellite, cable or other types of broadcasting), streaming on the Internet, Intranet (a corporate network) or other types of networks or distributing of electronic information (online digital music distribution service). You need to acquire the corresponding licenses for such uses. For details, see <http://www.mp3licensing.com>.

The names of companies and products mentioned herein are the trademarks of their respective owners.

- The music management software rekordbox is not covered under free repair, etc. given in the warranty. Before using the rekordbox, read carefully the terms given in the "Software License Agreement" of rekordbox.
- The specifications and design of this product are subject to change without notice.
- © 2014 PIONEER CORPORATION.
All rights reserved.
<DR11238-A>