



# LED BAR 45

## User Manual



**Please read this manual carefully before use!**



# BRIGHTLIGHT LED BAR 45

## USER MANUAL

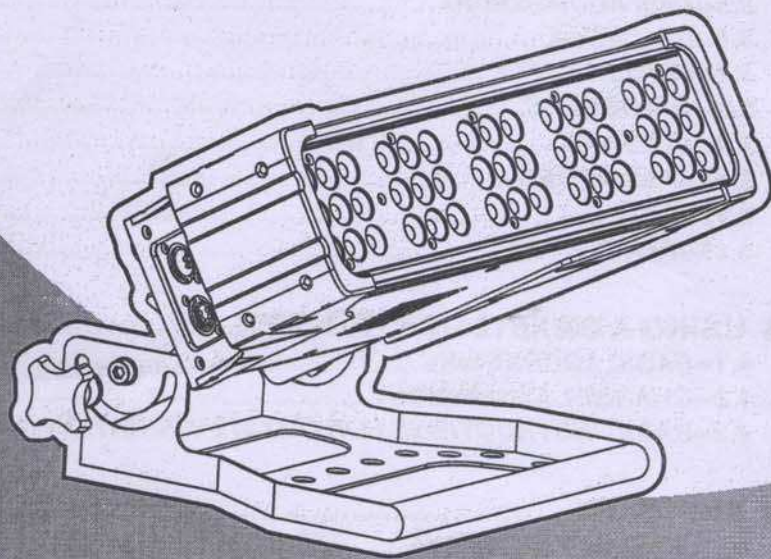

# T ABLE OF CONTENTS

<b>PART 1 PRODUCT (GENERAL)</b> .....	<b>1.</b>
1.1--PRODUCT INTRODUCTION.....	1.
1.2--PRODUCT FEATURES.....	1.
1.3--TECHNICAL SPECIFICATIONS.....	2.
1.4--PHOTOMETRIC DATA.....	3.
1.5--SAFETY WARNING.....	4.
<b>PART 2 INSTALLATION</b> .....	<b>5.</b>
2.1--MOUNTING.....	5.
2.2--POWER CONNECTION.....	5.
2.3--SETTING UP WITH A DMX512 CONTROLLER.....	6.
2.3-1--DMX512 ADDRESSING WITHOUT ID ADDRESSING.....	6.
2.3-2--DMX512 ADDRESSING WITH ID ADDRESS.....	6.
<b>PART 3 DISPLAY PANEL OPERATION</b> .....	<b>7.</b>
3.1--BASIC.....	7.
3.2--MENU.....	8.
3.3--STATIC COLOR.....	9.
3.4--AUTO.....	9.
3.5--DMX ADDRESSING.....	9.
3.6--RUN MODE.....	10.
3.7--PERSONALITY.....	10.
3.8--ID ADDRESS.....	10.
3.9--SETTINGS.....	10.
3.10--PASSWORD.....	11.
3.11--EDIT.....	11.
3.12--FAN SETTING.....	11.
<b>PART 4 USING A DMX512 CONTROLLER</b> .....	<b>12.</b>
4.1--BASIC ADDRESSING.....	12.
4.2--CHANNEL ASSIGNMENT.....	12.
4.3--BASIC INSTRUCTIONS FOR DMX512 OPERATION (STAGE 1).....	16.
<b>PART 5 APPENDIX</b> .....	<b>17.</b>
5.1--TROUBLE SHOOTING.....	17.
5.2--MAINTENANCE.....	18.

# 1 PRODUCT (GENERAL)

## 1.1 PRODUCT INTRODUCTION

This product is designed for indoor use. Suitable applications include wash or effect lighting for stage or nightclub applications. This product can also be installed for use in signage and advertising using the dynamic functions available with DMX512 control. Direct input of DMX512 signal allows the units to be controlled from any DMX512 controller. This product can be operated as a single unit or in multiple units for large applications.

The specially developed controller that allows the product to be controlled independent of the DMX512 controller enables the user to create and edit a wide range of custom programs. All programs can be touch-button displayed or scheduled to START and END at scheduled times. When programs have been created or edited in the controller, it is also possible to trigger these programs using the DMX IN function when connected to a DMX512 controller.

## 1.2 PRODUCT FEATURES

### LED FIXTURE

- \* RGB Dimmer 0-100%
- \* Strobe
- \* Automatic/Customs programs
- \* LCD display
- \* Display control 'lock-out'
- \* Direct DMX512 input
- \* Independant ID address
- \* Stand-alone/ Slave
- \* 'Over-heat' protection
- \* Fan speed control

# 1.3 TECHNICAL SPECIFICATIONS

## LED MODULE

LED MODULE:	
Voltage	AC 100~240V...50/60Hz
Rated Power	85W
LED/Unit	45pcs (15 x RED / 15 x GREEN / 15 x BLUE)
Output/LED	1W
Environment Temperature	-20°C~40°C
Cooling	Forced air convection
Dimensions	430 x 310 x 300mm
Weight	6Kg

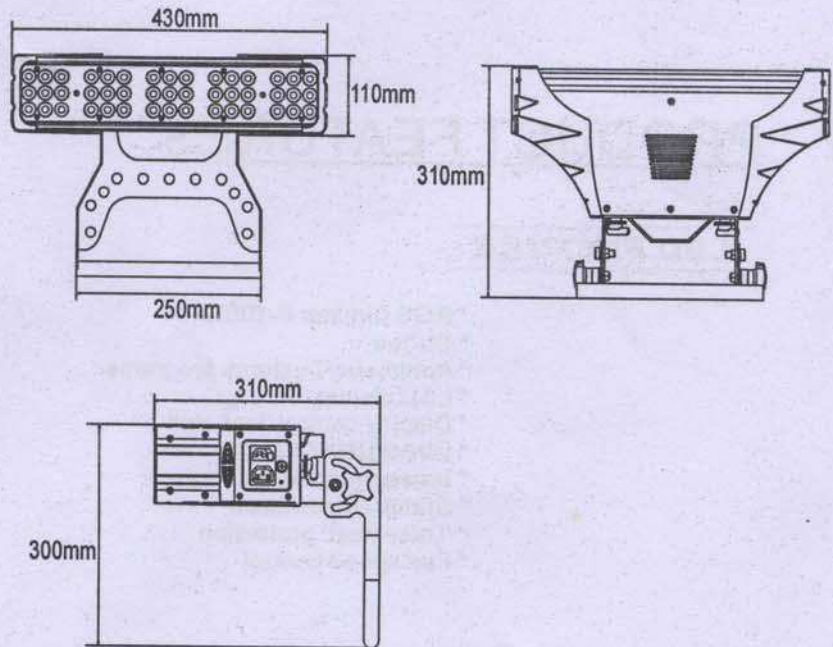

# 1.4 PHOTOMETRIC DATA

## PHOTOMETRIC DATA

### RED

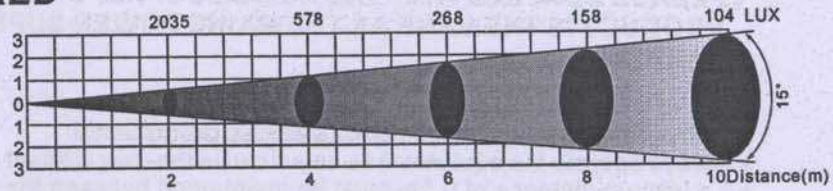

### GREEN

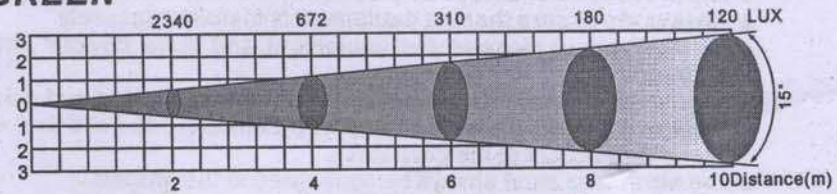

### BLUE

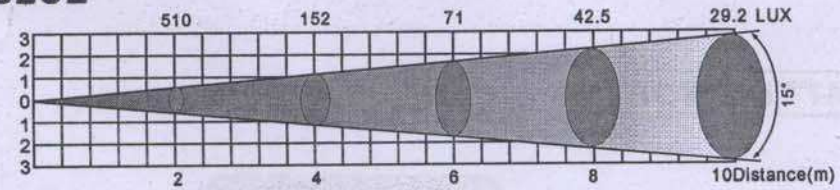

### RGB

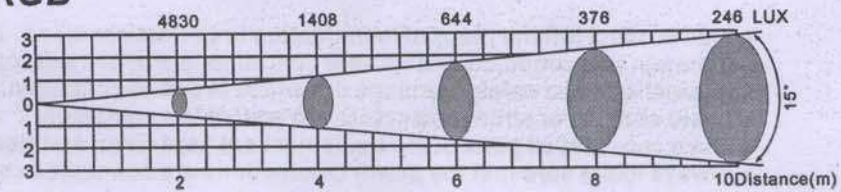

### WHITE

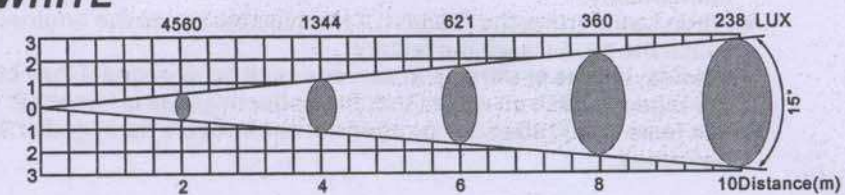

## 1.5 SAFETY WARNING

### IMPORTANT

**[ALWAYS READ THE USER MANUAL BEFORE OPERATION. ]**  
**[PLEASE CONFIRM THAT THE POWER SUPPLY STATED ON THE PRODUCT IS THE SAME AS THE MAINS POWER SUPPLY IN YOUR AREA.]**

- This product must be installed by a qualified professional.
- Always operate the equipment as described in the user manual.
- A minimum distance of 0.5m must be maintained between the equipment and combustible surface.
- The product must always be placed in a well ventilated area.
- Always make sure that the equipment is installed securely.
- DO NOT stand close to the equipment and stare directly into the LED light source.
- Always disconnect the power supply before attempting and maintenance.
- Always make sure that the supporting structure is solid and can support the combined weight of the products.
- The earth wire must always be connected to the ground.
- Do not touch the power cables if your hands are wet.

### ATTENTION

#### **⚠ ATTENTION ⚠**

- This product left the place of manufacture in perfect condition. In order to maintain this condition and for safe operation, the user must always follow the instructions and safety warnings described in this user manual.
- Avoid shaking or strong impacts to any part of the equipment.
- Make sure that all parts of the equipment are kept clean and free of dust.
- Always make sure that the power connections are connected correct and secure.
- If there is any malfunction of the equipment, contact your distributor immediately.
- When transferring the product, it is advisable to use the original packaging in which the product left the factory.
- Shields, lenses or ultraviolet screens shall be changed if they have become damaged to such an extent that their effectiveness is impaired.
- The lamp (LED) shall be changed if it has become damaged or thermally deformed.

# 2 INSTALLATION

## 2.1 MOUNTING

### UPLIGHT

The LED mini BATTEN can be mounted in an upright or sitting position using the supporting brackets.

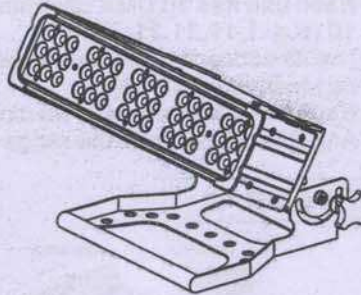

### HANGING

The LED mini BATTEN can be mounted in a hanging position using the supporting bracket. The bracket should be secured to the mounting truss or structure using a standard mounting clamp. Please note that when hanging the unit a safety cable should also be used.

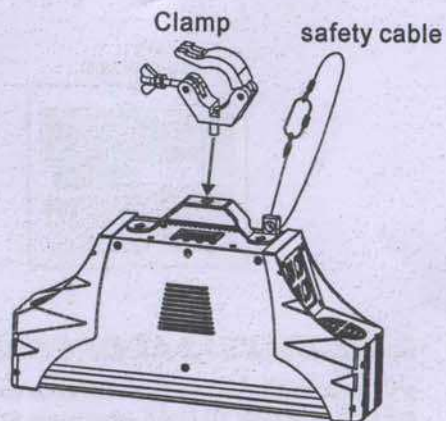

The LED MODULE can be mounted at any angle and in any position. It is possible to further adjust the angle of the LED MODULE using the two adjustment knobs located on the side of the fixture.

## 2.2 POWER CONNECTIONS

@ 220V: 15 units may be connected in series

@ 120V: 10 units may be connected in series

**Note:** As this fixture's DMX signal cable connection had been changed to Parallel connection, so if over 30 units to be connected, then a DMX signal amplifier is needed.



## 2.3 SETTING UP WITH A DMX512 CONTROLLER

### 2.3-1 DMX512 ADDRESSING WITHOUT ID ADDRESSING (STAGE 1 MODE)

- Connect the DMX512 controller to the units in series.
- Each unit has 10 DMX channels so the DMX Addresses should increase by increments of 10 (e.g. 1,11,21,31...)
- The ID address has not been set so therefore when using the controller Ch9 must be inactive (CH9=0).
- Each DMX Address may be used as many times as required.
- Any DMX address in the range from 001 to 512 may be used.

#### Example:

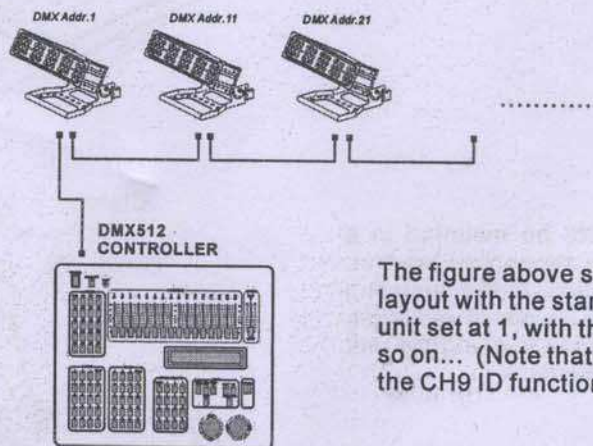

The figure above shows a simple DMX512 layout with the starting address of the first unit set at 1, with the second set at 11 and so on... (Note that when used in this way, the CH9 ID function must be inactive (CH9=0))

### 2.3-2 DMX512 ADDRESSING WITH ID ADDRESS (STAGE 1 MODE)

- Connect the DMX512 controller to the units in series
- Each unit has 10 DMX channels so the DMX Addresses should increase by increments of 10 (e.g. 1,11,21,31...)
- Each DMX Address may be used as many times as required.
- Any DMX address in the range from 001 to 512 may be used.
- Each DMX address may carry up to 66 separate ID addresses.
- **[ID]** should be set in the menu on each unit in ascending values (i.e. 1,2,3...)
- ID addresses are accessible from Ch9 on the DMX512 controller.

#### Example:

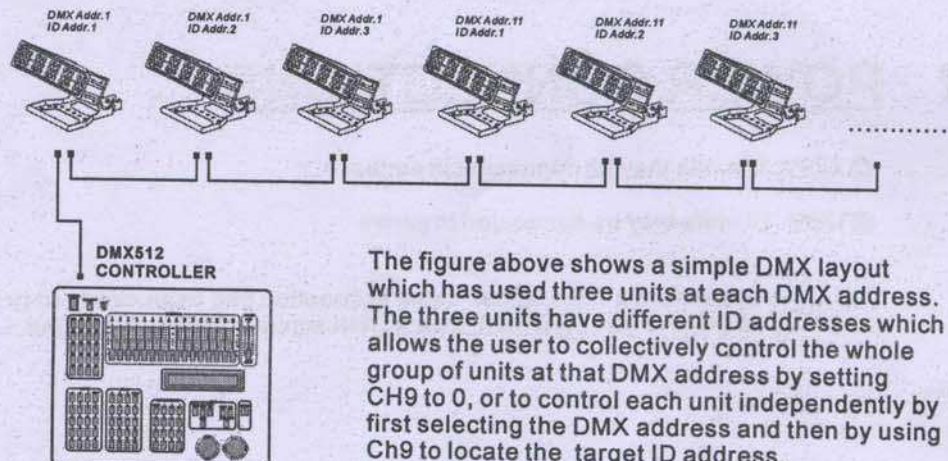

The figure above shows a simple DMX layout which has used three units at each DMX address. The three units have different ID addresses which allows the user to collectively control the whole group of units at that DMX address by setting CH9 to 0, or to control each unit independently by first selecting the DMX address and then by using CH9 to locate the target ID address.

# 3 DISPLAY PANEL OPERATION

## 3.1 BASIC

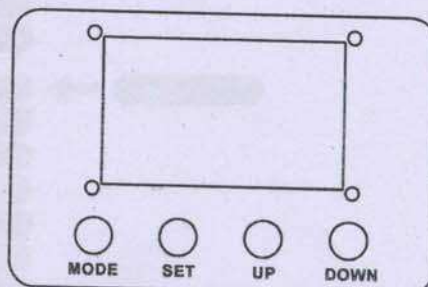

- 【 MODE 】** scroll through the main menu or exit from the current menu or function
- 【 SET 】** Enter the currently selected menu or confirm the current function value
- 【 UP 】** scroll 'UP' through the menu list or increase the value of the current function
- 【 DOWN 】** scroll 'DOWN' through the menu list or decrease the value of the current function

## 3.2 MENU

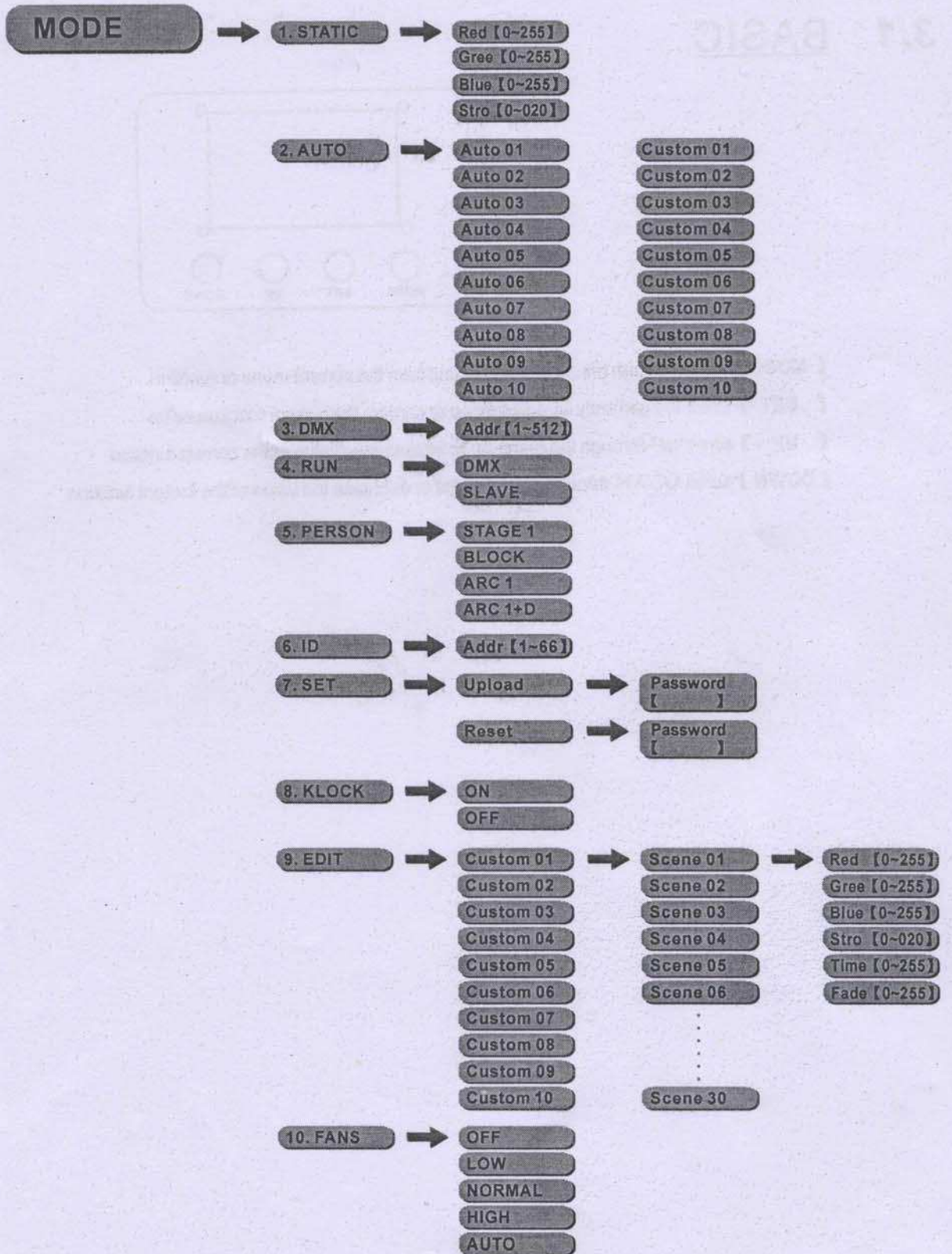

### 3.3 STATIC COLOR

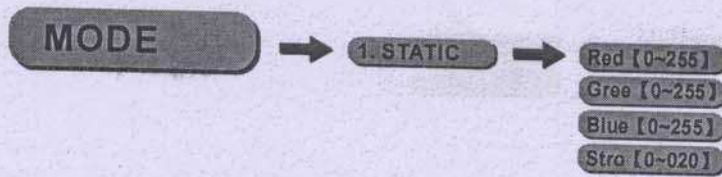

#### **[STATIC]**

- Select **[Red]** / **[Gree]** / **[Blue]** / **[Stro]** and set the value by pressing **[UP]** and **[DOWN]**
- Press **[SET]** to save and back to the upper menu
- The fixture will be automatic in Master running mode under this function

### 3.4 AUTO

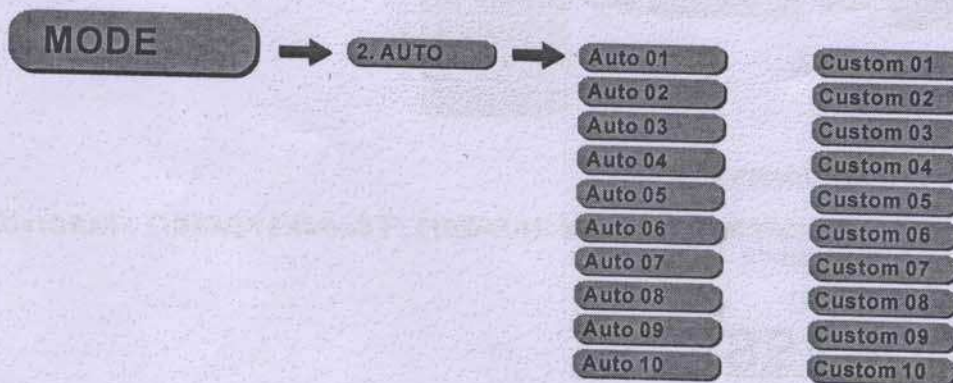

#### **[AUTO]**

- Select the target **[AUTO]** program and press **[SET]**
- Programs **[Auto 01]** to **[Auto 10]** are fully pre-programmed and will not be altered
- Programs **[Custom 01]** to **[Custom 10]** are fully pre-programmed and can be edited in **[EDIT]** mode
- The fixture will be automatic in Master running mode under this function

### 3.5 DMX ADDRESSING



#### **[DMX]**

- Enter **[DMX]** and set the DMX address **[1-512]**
- Press **[SET]** save the setting.

### 3.6 RUN MODE



#### 【RUN】

- Enter the **【MODE】** mode to set working mode.
- **【DMX】** mode is for using the DMX512 controller to control the fixtures.
- **【SLAVE】** mode is for Master -- Slave operation, or controlled fixture by Pix-controller.

**Note:** When fixtures are under Auto program operation, the **【MODE】** no works.

### 3.7 PERSONALITY



#### 【PERSONALITY】

- Enter **【PERSON】** and select **【STAGE1】** / **【BLOCK】** / **【ARC1】** / **【ARC1+D】** DMX mode

### 3.8 ID ADDRESS



#### 【ID address】

- Enter **【ID】** and set the ID address **【1~066】**

### 3.9 SETTINGS



#### 【Upload】

- Select **【Upload】** to upload the custom programs from the current MASTER unit to the SLAVE units.
- In order to activate the upload function the password must be entered
- Password is the same as the main access password
- When uploading the MASTER and SLAVE units will display YELLOW
- If an error occurs when uploading the MASTER and/or SLAVE units will display RED
- On successful uploading of the custom programs the MASTER and SLAVE units will display GREEN.

#### 【Reset】

- This function will reset all setting to the original factory setting

### 3.10 PASSWORD



**[Password]**

- Enter the **[KLOCK]** mode to set password ON/OFF
- When password is activated, display will demand password each time the fixture is powered on.
- The factory default password is **[UP] > [DOWN] > [UP] > [DOWN]**

### 3.11 EDIT

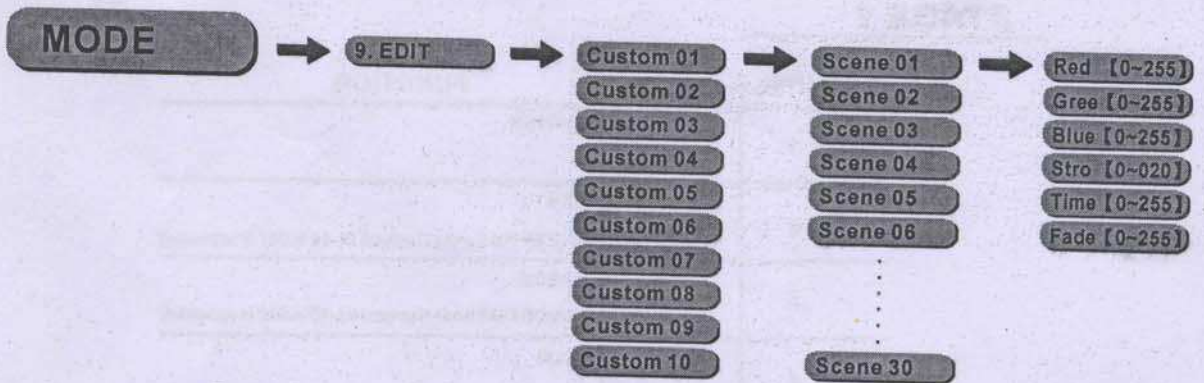

**[EDIT]**

- Enter **[EDIT]** to edit the custom programs **[Custom 1]** to **[Custom 10]**
- Each program has 100 steps to edit
- Each step allows a creation of a scene using Red, Green, Blue, Strobe, Step time, Fade time

### 3.12 FAN SETTING



**[FANS]**

- Enter **[FANS]** and select the working mode of fan: **[Auto]** , **[Off]** , **[Low]** , **[Normal]** or **[High]**

# 4 USING A DMX512 CONTROLLER

## 4.1 BASIC ADDRESSING

- Connect all of the units in series using standard DMX512 signal cable or the IP65 rated cable provided.
- Set the DMX512 address in the **[DMX]** menu.
- It is possible to have the same DMX address or independent addresses for each fixture.

## 4.2 CHANNEL ASSIGNMENT

- Note: This product have three DMX512 channel configuration: **[STAGE 1]** , **[BLOCK]** , **[ARC 1]** and **[ARC 1+D]**

### STAGE 1

CHANNEL	VALUE	FUNCTION
1		DIMMER
	0 ↔ 255	
2		RED
	0 ↔ 255	(or STEP TIME when Customs 01-10 in Ch7 is activated)
3		GREEN
	0 ↔ 255	(or FADE TIME when Customs 01-10 in Ch7 is activated)
4		BLUE
	0 ↔ 255	
5	0 ↔ 10	MARCO No function
	11 ↔ 35	RED 100% / GREEN UP / BLUE 0%
	36 ↔ 60	RED DOWN / GREEN 100% / BLUE 0%
	61 ↔ 85	RED 0% / GREEN 100% / BLUE UP
	86 ↔ 110	RED 0% / GREEN DOWN / BLUE 100%
	111 ↔ 135	RED UP / GREEN 0% / BLUE 100%
	136 ↔ 160	RED 100% / GREEN 0% / BLUE DOWN
	161 ↔ 185	RED 100% / GREEN UP / BLUE UP
	186 ↔ 210	RED DOWN / GREEN DOWN / BLUE 100%
	211 ↔ 215	WHITE 1: 3200K
	216 ↔ 220	WHITE 2: 3400K
	221 ↔ 225	WHITE 3: 4200K
	226 ↔ 230	WHITE 4: 4900K
	231 ↔ 235	WHITE 5: 5600K
	236 ↔ 240	WHITE 6: 5900K
	241 ↔ 245	WHITE 7: 6500K
246 ↔ 250	WHITE 8: 7200K	
251 ↔ 255	WHITE 9: 8500K	
6		STROBE
	0 ↔ 9	No function
	10 ↔ 255	Strobe speed (0-20Hz)

CHANNEL	VALUE	FUNCTION
7	0 ↔ 10	Fans, Auto Reset to display Fan setting
	11 ↔ 20	Fan closed (activated after 5 seconds)
	21 ↔ 30	Fan low speed (activated after 5 seconds)
	31 ↔ 40	Fan normal (activated after 5 seconds)
	41 ↔ 50	Fan high speed (activated after 5 seconds)
	51 ↔ 60	Fan auto speed (activated after 5 seconds)
	61 ↔ 70	Auto 1
	71 ↔ 80	Auto 2
	81 ↔ 90	Auto 3
	91 ↔ 100	Auto 4
	101 ↔ 110	Auto 5
	111 ↔ 120	Auto 6
	121 ↔ 130	Auto 7
	131 ↔ 140	Auto 8
	141 ↔ 150	Auto 9
	151 ↔ 160	Auto 10
	161 ↔ 170	Custom 1
	171 ↔ 180	Custom 2
	181 ↔ 190	Custom 3
	191 ↔ 200	Custom 4
	201 ↔ 210	Custom 5
	211 ↔ 220	Custom 6
	221 ↔ 230	Custom 7
	231 ↔ 240	Custom 8
	241 ↔ 250	Custom 9
251 ↔ 255	Custom 10	
8		<b>AUTO SPEED ADJUSTMENT</b>
	0 ↔ 255	When using CH7,AUTO01-AUTO10, this function activated
9		<b>ID ADDRESS</b>
	0 ↔ 9	ID1~ID66
	10 ↔ 19	ID1
	20 ↔ 29	ID2
	30 ↔ 39	ID3
	40 ↔ 49	ID4
	50 ↔ 59	ID5
	60 ↔ 69	ID6
	70 ↔ 79	ID7
	80 ↔ 89	ID8
	90 ↔ 99	ID9
	100 ↔ 109	ID10
	110 ↔ 119	ID11
	120 ↔ 129	ID12
	130 ↔ 139	ID13
	140 ↔ 149	ID14
	150 ↔ 159	ID15
160 ↔ 169	ID16	



CHANNEL	VALUE	FUNCTION	
9	170 ↔ 179	ID17	
	180 ↔ 189	ID18	
	190 ↔ 199	ID19	
	200 ↔ 209	ID20	
	210	ID21	
	211	ID22	
	⋮	⋮	
	254	ID65	
	255	ID66	
	10		<b>BLOCK</b>
		0 ↔ 10	BLOCK1,BLOCK2,BLOCK3,BLOCK4,BLOCK5
11 ↔ 21		BLOCK1	
22 ↔ 32		BLOCK2	
33 ↔ 43		BLOCK3	
44 ↔ 54		BLOCK4	
55 ↔ 65		BLOCK5	
66 ↔ 76		BLOCK1,BLOCK2	
77 ↔ 87		BLOCK2,BLOCK3	
88 ↔ 98		BLOCK3,BLOCK4	
99 ↔ 109		BLOCK4,BLOCK5	
121 ↔ 131		BLOCK1,BLOCK2,BLOCK3	
132 ↔ 142		BLOCK2,BLOCK3,BLOCK4	
143 ↔ 153		BLOCK3,BLOCK4,BLOCK5	
154 ↔ 164		BLOCK1,BLOCK5	
165 ↔ 175		BLOCK2,BLOCK4	
176 ↔ 186		BLOCK1,BLOCK3	
187 ↔ 197		BLOCK2,BLOCK5	
198 ↔ 208		BLOCK1,BLOCK3,BLOCK5	
209 ↔ 219		BLOCK1,BLOCK2,BLOCK4,BLOCK5	
220 ↔ 230	BLOCK1,BLOCK2		
231 ↔ 241	BLOCK4,BLOCK5		
242 ↔ 255	BLOCK1,BLOCK2,BLOCK3,BLOCK4,BLOCK5		

## **BLOCK**

CHANNEL	VALUE	FUNCTION
1	0 ↔ 255	BLOCK1-RED
2	0 ↔ 255	BLOCK1-GREEN
3	0 ↔ 255	BLOCK1-BLUE
4	0 ↔ 255	BLOCK2-RED
5	0 ↔ 255	BLOCK2-GREEN
6	0 ↔ 255	BLOCK2-BLUE
7	0 ↔ 255	BLOCK3-RED
8	0 ↔ 255	BLOCK3-GREEN
9	0 ↔ 255	BLOCK3-BLUE
10	0 ↔ 255	BLOCK4-RED
11	0 ↔ 255	BLOCK4-GREEN
12	0 ↔ 255	BLOCK4-BLUE
13	0 ↔ 255	BLOCK5-RED
14	0 ↔ 255	BLOCK5-GREEN
15	0 ↔ 255	BLOCK5-BLUE

## **ARC 1**

CHANNEL	VALUE	FUNCTION
1	0 ↔ 255	RED
2	0 ↔ 255	GREEN
3	0 ↔ 255	BLUE

## **ARC 1+D**

CHANNEL	VALUE	FUNCTION
1	0 ↔ 255	MASTER DIMMER
2	0 ↔ 255	RED
3	0 ↔ 255	GREEN
4	0 ↔ 255	BLUE

## **4.3 BASIC INSTRUCTIONS FOR DMX512 OPERATION (STAGE 1)**

### **MASTER DIMMER**

- CH1 controls the intensity of the currently projected color
- When the slider is at the highest position (255) the intensity of the output is the maximum

### **RED, GREEN & BLUE COLOR SELECTION**

- CH2, CH3 & CH4 control the intensity ratio of each of the RED, GREEN & BLUE LEDs.
- When the slider is at the highest position (255) the intensity of the color is the maximum.
- CH2, CH3 & CH4 can be combined together to create over 16 million colors.

### **COLOR MACROS**

- CH5 selects the required COLOR MACRO
- CH5 has priority over CH2, CH3 and CH4
- CH1 is used to control the intensity of the COLOR MACRO

### **STROBE**

- CH 6 controls the strobe of CH1 to CH5

### **ID ADDRESS SELECTION**

- CH9 is used to select the target ID address.
- Each independent DMX address may have upto 66 independent ID addresses.
- An ID address of 0 will activate all ID address locations.

### **AUTO**

- CH7 selects the Fan Function, the preset AUTO programs Auto 01-10 or the custom programs Custom 01-10
- CH7 has priority over CH2, 3, 4, 5.
- CH8 control speed of CH 7.

### **BLOCK**

- This fixture is divided as 5 blocks, each block include 3 red Leds, 3 green leds, 3 blue leds.

# 5 APPENDIX

## 5.1 TROUBLE SHOOTING

SITUATION	CAUSE	ACTION	PART ORDER NUMBER
No display	1) Power connection error	1) Check all power connections	
	2) Power switch damaged	2) Replace power switch	16-03-0030-03
	3) Display board damaged	3) Replace display board	26-2A-LED316DISP-00
LED MODULE on, but no control from display	1) Keyboard damaged	1) Replace keyboard	26-2A-LED316DISP-00
	2) Display board damaged	2) Replace display board	26-2A-LED316DISP-00
LEDs of the same color are not lit	1) LED PCB damaged	1) Check and Replace PCB board	26-2A-LED316LIGHT-00
	2) LED PCB connection error	2) Check the wire connection	
LED module on, LEDs of all colors are not lit	1) Driver PCB damaged	1) Replace driver PCB board	26-2A-LED316DRV-00
	2) LED PCB damaged	2) Replace PCB board	26-2A-LED316LIGHT-00
	3) LED PCB connection error	3) Check the wire connection	
Display normal, but no response to DMX 512 controller	1) Signal connection error	1) Check and replace signal cable	
	2) DMX Address error	2) Check and reset DMX address	
	3) Master & slave mode error	3) Check and reset the working mode	
	4) ID error	4) Check and reset ID address	

## 5.2 MAINTENANCE

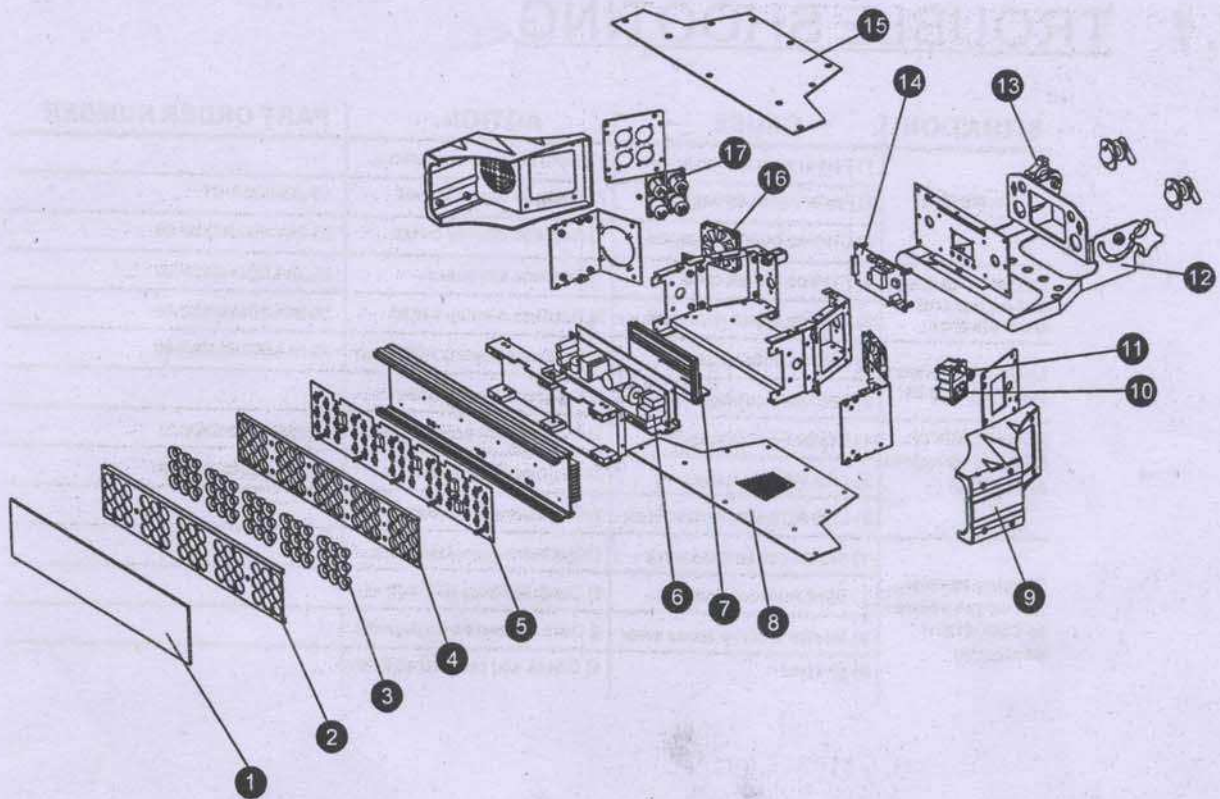

No	ITEM
1	Clear cover
2	lense upper cover
3	Lenses
4	Lense base cover
5	LED PCB
6	Power supply
7	LED driver PCB
8	Metal base cover
9	Plastic side cover
10	Power socket
11	Fuse socket
12	Bracket
13	Adjusting knob
14	Display PCB
15	Metal upper cover
16	Fan
17	DMX board

## EU-declaration of conformity



We hereby confirm that the following device

### **BRIGHTLIGHT LED BAR 45**

complies with the essential safety requirements, laid down in the regulations of the committee to assimilate the provisions of law of all participating EU states on the electromagnetic compatibility (89/336/EWG).

The device has been classified considering the following EU-norms on electromagnetic compatibility:

DIN EN 61000-3-2:2000 + A2: 2005

DIN EN 61000-3-3:1995 + A1: 2001

Assessment of compliance of the product with the requirements relating to the Low Voltage Directive (LVD 2006/95/EG) was based on the following standards:

DIN EN 60065 : 2002

Furthermore, the device is verified in correspondence to the laser class regulations DIN EN 60825-1, if properly set up according to the upper mentioned laser safety regulation. After installing the device, an inspection and official approval is indispensable for the overall setup. The inspection must follow the european guidelines EN 60825-1 and corresponding regulations for the prevention of accidents BGV-B2.

This declaration is executed on behalf of the BRIGHTLIGHT LED BAR 45 manufacturer

### **Brightlight GmbH** **Geschäftsführer: Martin Werner**

Rheinblick Residenz  
Oberstrasse 1  
8274 Tägerwilen  
SCHWEIZ

place of business: 8274 Tägerwilen / SWITZERLAND  
company number: CH-020.4.038.648-0  
Commercial Registry Kanton Thurgau

[www.brightlight-led.com](http://www.brightlight-led.com)  
[info@brightlight-led.com](mailto:info@brightlight-led.com)

[representative](#) according to EMVG:  
Cleantech Europe GmbH  
[Managing Director](#): Thomas Schulze  
Fürkhofstr. 5  
81927 München / DE