



User's Guide

Multimedia Projector

EB-536Wi EB-530

EB-535W EB-520



EB-525W

Notations Used in This Guide





- **Safety indications**

The documentation and the projector use graphical symbols to show how to use the projector safely.

The indications and their meaning are as follows. Make sure you understand them properly before reading the guide.

 Warning	This symbol indicates information that, if ignored, could possibly result in personal injury or even death due to incorrect handling.
 Caution	This symbol indicates information that, if ignored, could possibly result in personal injury or physical damage due to incorrect handling.

- **General information indications**

Attention	Indicates procedures which may result in damage or injury if sufficient care is not taken.
	Indicates additional information and points which may be useful to know regarding a topic.
	Indicates a page where detailed information regarding a topic can be found.
	Indicates that an explanation of the underlined word or words in front of this symbol appears in the glossary of terms. See the "Glossary" section of the "Appendix".  "Glossary" p.186
[Name]	Indicates the name of the buttons on the remote control or the control panel. Example: [Esc] button
Menu Name	Indicates Configuration menu items. Example: Select Brightness from Image . Image - Brightness

Notations Used in This Guide 2

Introduction

Projector Features 8

Quick and Easy Set up, Projection, and Storage	8
Connecting with a USB Cable and Projecting (USB Display)	8
Useful Functions for Projecting Images	8
Connect a USB Storage Device and Project Movies or Images (PC Free)	8
Flip the Image Horizontally and Project (Flip Horizontal)	8
Various Functions for Excellent Power Saving	8
Making the Most of the Remote Control	8
Enlarge and Project Your Files with the Document Camera	9
Enhanced Security Functions	9
Taking Full Advantage of a Network Connection	9
Interactive Features (Easy Interactive Function) (EB-536Wi only)	10

Part Names and Functions 11

Front/Top	11
Rear	12
Base	14
Control Panel	15
Remote Control	16
Replacing the Remote Control Batteries	18
Remote Control Operating Range	19
Easy Interactive Pen (EB-536Wi only)	19
Replacing the Battery for the Interactive Pen	20
Replacing the Tip of the Interactive Pen	21

Preparing the Projector

Installing the Projector 23

Installation Methods	23
Installation Methods	24
When Using the Interactive Features (EB-536Wi only)	24

Connecting Equipment 26

Connecting a Computer	26
Connecting Image Sources	28
Connecting USB Devices	30
Connecting a Microphone	32
Connecting External Equipment	33
Connecting a LAN Cable	35
Installing the Optional Wireless LAN Unit	36
Installing the Optional Quick Wireless Connection USB Key	37
Connecting Multiple Projectors (EB-536Wi only)	38

Basic Usage

Projecting Images 41

Turning On the Projector	41
Turning Off the Projector	42
Automatically Detect Input Signals and Change the Projected Image (Source Search)	43
Switching to the Target Image Using the Remote Control	44
Projecting with USB Display	45
System requirements	45
Connecting for the First Time	46
Uninstalling	47

Adjusting Projected Images 48

Correcting Keystone Distortion	48
Correcting Manually	49
Correcting Automatically (EB-536Wi only)	52
Adjusting the Image Size	52
Adjusting the Image Position	52
Adjusting the Horizontal Tilt	52
Correcting the Focus	53
Adjusting the Volume	53
Selecting the Projection Quality (Selecting Color Mode)	53
Setting Auto Iris	54
Changing the Aspect Ratio of the Projected Image	55
Changing Methods	55

Changing the Aspect Mode (EB-536Wi/EB-535W/EB-525W only) 55
 Changing the Aspect Mode (EB-530/EB-520 only) 56

Using the Interactive Features (EB-536Wi only)

Interactive Feature Modes 59
 Drawing on a Projected Image (Annotation Mode) 60
 Using the Projected Screen as a Whiteboard (Whiteboard Mode) 61
 Controlling a Computer from the Projected Screen (Computer Interactive Mode) . . 62
 Computer Interactive Mode System Requirements 62
 Using Computer Interactive Mode 62
 Easy Interactive Driver System Requirements (OS X only) 65
 Installing Easy Interactive Driver on OS X 65

Using the Interactive Pens 67
 Pen Calibration 68
 Calibrating Automatically 68
 Calibrating Manually 69
 Adjusting the Pen Operation Area 71

Interacting with the Screen 74
 Switching the Interactive Mode 74
 Annotation Mode and Whiteboard Mode Toolbars 75
 Selecting Line Width and Color 76
 Selecting Whiteboard Templates 77
 Projector Control Toolbar 77
 Selecting Network Device Display from the Projector Control Toolbar 78

Using the Interactive Features over a Network 80
 Precautions When Connecting to a Projector on a Different Subnet 80

Windows Pen Input and Ink Tools 82
 Enabling Windows Pen Input and Ink Features 82
 Using Windows Pen Input and Ink Features 83

Useful Functions

Projection Functions 85
 Projecting Images Stored on a USB Storage Device (PC Free) 85
 Specifications for Files that Can Be Projected Using PC Free 85
 PC Free Examples 85
 PC Free Operating Methods 86
 Projecting the Selected Images or Movies 87
 Projecting Image Files in a Folder in Sequence (Slideshow) 88
 Image File Display Settings and Slideshow Operation Settings 89
 Flipping the Image Horizontally (Flip Horizontal) 90
 Hiding the Image and Sound Temporarily (A/V Mute) 90
 Freezing the Image (Freeze) 91
 Pointer Function (Pointer) 91
 Enlarging Part of the Image (E-Zoom) 92
 Using the Remote Control to Operate the Mouse Pointer (Wireless Mouse) 93
 Saving a User's Logo 95
 Saving User Pattern 96

Security Functions 98
 Managing Users (Password Protection) 98
 Kinds of Password Protection 98
 Setting Password Protection 98
 Entering the Password 99
 Restricting Operation (Control Panel Lock) 100
 Anti-Theft Lock 101
 Installing the Wire Lock 101

Monitoring and Controlling 102
 About EasyMP Monitor 102
 Message Broadcasting 102
 Changing Settings Using a Web Browser (Web Control) 102
 Projector Setup 102
 Displaying the Web Control Screen 103
 Displaying the Web Remote screen 103
 Using the Mail Notification Function to Report Problems 104
 Reading Error Notification Mail 105
 Management Using SNMP 105

ESC/VP21 Commands 106
 Command list 106
 Cable Layouts 106
 About PLink 107
 About Crestron RoomView® 108
 Operating a Projector from Your Computer 108

Reflecting Saved Settings to Other Projectors 137
 Setup by Connecting the Computer and Projector with a USB Cable 138
 Saving Settings to a Computer 138
 Reflecting Saved Settings to Other Projectors 139
 When Setup Fails 140

Configuration Menu

Using the Configuration Menu 113

List of Functions 114

Configuration Menu Table 114
 Network menu 115
 Image Menu 116
 Signal Menu 117
 Settings Menu 119
 Extended Menu 120
 Easy Interactive Function Setting Items (EB-536Wi only) 123
 Network Menu 124
 Notes on Operating the Network Menu 125
 Soft Keyboard Operations 125
 Basic Menu 126
 Wireless LAN Menu 127
 Search Access Point screen 129
 Security Menu 129
 Wired LAN Menu 130
 Mail Menu 131
 Others Menu 132
 Reset Menu 133
 ECO Menu 133
 Info Menu (Display Only) 134
 Reset Menu 135

Performing Batch Setup for Multiple Projectors 136

Setting Up Using a USB Memory 136
 Saving Settings to a USB Memory 136

Troubleshooting

Using the Help 142

Problem Solving 143

Reading the Indicators 143
 When the Indicators Provide No Help 147
 Problems Relating to Images 148
 No Images Appear 148
 Moving Images are Not Displayed (Only the Moving Image Portion Turns Black) 149
 Projection Stops Automatically 149
 The Message Not supported is Displayed 149
 The Message No Signal is Displayed 150
 Images are Fuzzy, Out of Focus, or Distorted 150
 Interference or Distortion Appear in Images 151
 The Mouse Cursor Flickers (Only when Projecting USB Display) 152
 The Image Is Truncated (Large) or Small, or the Aspect Is Not Suitable 152
 Image Colors are Not Right 153
 Images Appear Dark 153
 Problems when Projection Starts 154
 The Projector Does Not Turn On 154
 Other Problems 154
 No Sound can be Heard or the Sound is Faint 154
 No Sound can be Heard from the Microphone 155
 There is Noise in the Audio (Only when Projecting USB Display) 155
 The Remote Control Does Not Work 156
 I Want to Change the Language for Messages and Menus 156
 Mail is Not Received even if a Problem Occurs in the Projector 156
 Cannot Change Settings Using a Web Browser 157
 Problems with the Interactive Features (EB-536Wi only) 157
 Cannot Draw on the Projected Screen 157

Cannot Operate a Computer from the Projected Screen After Connecting to the Computer 158

The Message An error occurred in the Easy Interactive Function. is Displayed . . . 158

Computer's Mouse Does Not Work Correctly 158

The Interactive Pen Does Not Work 159

The Response Time for the Interactive Pen is Slow (Only when Projecting USB Display) 159

The Dot Moves Automatically or Does Not Move to the Next Position During Manual Calibration 160

About Event ID 161

Maintenance

Cleaning 163

Cleaning the Projector's Surface 163

Cleaning the Lens 163

Cleaning the Air Filter 163

Replacing Consumables 166

Replacing the Lamp 166

Lamp Replacement Period 166

How to Replace the Lamp 166

Resetting the Lamp Hours 169

Replacing the Air Filter 169

Air Filter Replacement Period 169

How to Replace the Air Filter 169

Appendix

Optional Accessories and Consumables 172

Optional Accessories 172

Consumables 172

Screen Size and Projection Distance 173

Projection Distance (for EB-536Wi/EB-535W/EB-525W) 173

Projection Distance (For EB-530/EB-520) 174

Supported Monitor Displays 176

Supported Resolutions 176

Computer Signals (analog RGB) 176

Component Video 176

Composite Video 176

Input Signal from the HDMI Port 176

Specifications 178

Projector General Specifications 178

Appearance 184

Glossary 186

General Notes 188

Wireless Telegraphy Act Regulations 188

About Notations 188

General Notice: 189

Index 190



Introduction

This chapter explains the projector's features and the part names.

Quick and Easy Set up, Projection, and Storage

- Turn the projector on and off by simply plugging in or unplugging.
- Projection only starts when a computer image is input (Auto Power On).
- Project onto large screens from a short distance.
- Make easy height adjustments with one lever.
- No cool down delay makes it easy to put away.

Connecting with a USB Cable and Projecting (USB Display)

By simply connecting a USB cable, you can project images from a computer's screen without a Computer cable.

☛ "Projecting with USB Display" [p.45](#)

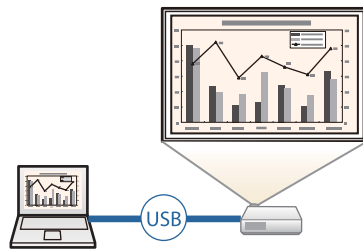

Useful Functions for Projecting Images

Connect a USB Storage Device and Project Movies or Images (PC Free)

You can connect USB storage devices or digital cameras to the projector and project saved images.

A wide range of file formats are supported such as movies or images.

☛ "Projecting Images Stored on a USB Storage Device (PC Free)" [p.85](#)

Flip the Image Horizontally and Project (Flip Horizontal)

You can temporarily flip the image horizontally and project. This is useful when projecting images for dance lessons and so on.

☛ "Flipping the Image Horizontally (Flip Horizontal)" [p.90](#)

Various Functions for Excellent Power Saving

- Various functions to prevent wasting electricity
The projector comes with a number of built-in functions to save power such as dimming the projected image, an auto power off timer, and adjusting power consumption while the projector is standing by.

☛ "ECO Menu" [p.133](#)

- Function for displaying the power-saving status on the projected screen
When ECO Display is set to **On** from the Configuration menu, leaf icons () that indicate the power-saving status are displayed at the bottom-left of the projected screen when the lamp brightness has switched to low brightness.

☛ ECO - ECO Display [p.133](#)

Making the Most of the Remote Control

You can use the remote control to perform operations such as enlarging part of the image. You can also use the remote control as a pointer during presentations or as a mouse for the computer.

☛ "Pointer Function (Pointer)" [p.91](#)

☛ "Enlarging Part of the Image (E-Zoom)" [p.92](#)

☛ "Using the Remote Control to Operate the Mouse Pointer (Wireless Mouse)" [p.93](#)

Enlarge and Project Your Files with the Document Camera

You can project paper documents and objects using the optional Document Camera.

By connecting to a computer and using the software supplied, you can make full use of the projector's capabilities.

☛ "Optional Accessories" [p.172](#)

Enhanced Security Functions

- **Password Protect to restrict and manage users**

By setting a Password you can restrict who can use the projector.

☛ "Managing Users (Password Protection)" [p.98](#)

- **Control Panel Lock to restrict button operation on the control panel**

You can use this to prevent people changing projector settings without permission at events, in schools, and so on.

☛ "Restricting Operation (Control Panel Lock)" [p.100](#)

- **Equipped with various anti-theft devices**

The projector is equipped with the following types of anti-theft security devices.

- Security slot
- Security cable installation point

☛ "Anti-Theft Lock" [p.101](#)

Taking Full Advantage of a Network Connection

You can perform the following operations by using EasyMP Network Projection and EasyMP Multi PC Projection that can be found on the EPSON Projector Software CD-ROM.

- **Sharing the projector over a network**

By using EasyMP Network Projection, you can connect the projector to a network and share it with multiple computers. You can project images and data from each computer without having to reconnect cables. You can also project to multiple projectors from one computer.

☛ [EasyMP Network Projection Operation Guide](#)



- **Projecting images from multiple computers simultaneously**

By using EasyMP Multi PC Projection, up to four screens from multiple computers connected to the network, or from smartphones or tablets with Epson iProjection installed, can be projected simultaneously.

By making yourself the host of a meeting, you can control the projected screens from other connected computers allowing you to advance the meeting smoothly.

You can also project the same screen from remote projectors on the network.

☛ [EasyMP Multi PC Projection Operation Guide](#)

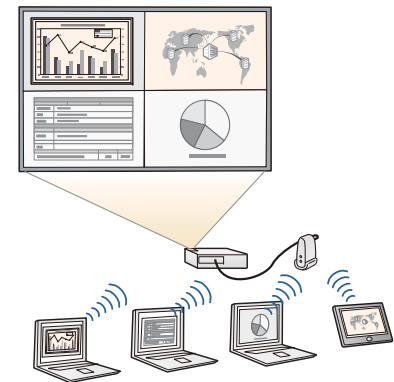

You can perform the following operations by using optional devices and applications.

- Wirelessly projecting your computer's screen

By installing the optional Wireless LAN unit, you can project a computer screen over a network.

☛ "Installing the Optional Wireless LAN Unit" p.36



- Connecting to a computer with Quick Wireless easily

By simply connecting the optional Quick Wireless Connection USB Key to a computer, you can automatically perform network settings for a wireless LAN connection, and project the computer's screen (Windows only).

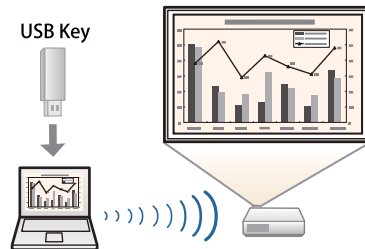

- Projecting images from portable devices over a network

If Epson iProjection is installed on your smart phone or tablet device, you can wirelessly project data from the device. You can download Epson iProjection for free from the App Store or from Google play. Any fees incurred when communicating with the App Store or Google play are the responsibility of the customer.



Interactive Features (Easy Interactive Function) (EB-536Wi only)

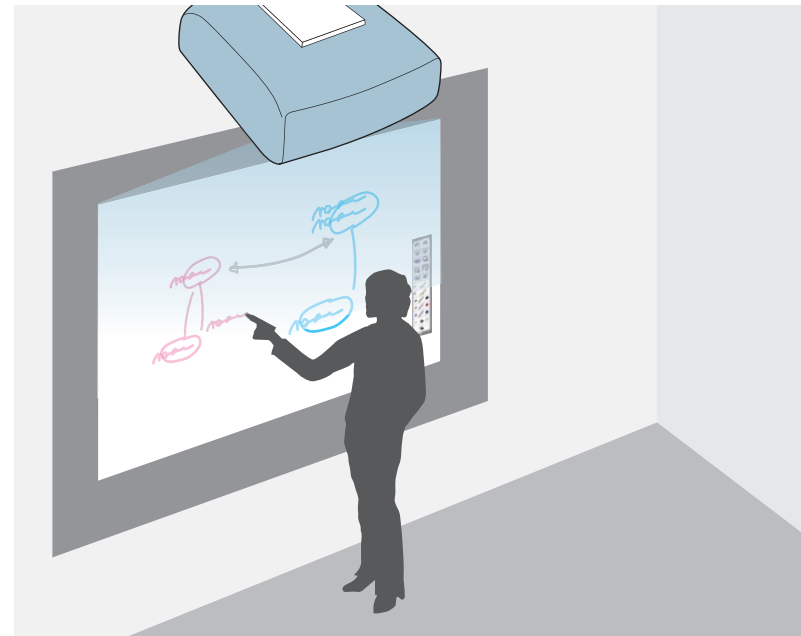

You can perform the following operations with the interactive pen.

- Use the projected screen as a whiteboard
 - Draw on content projected from a computer
 - Operate a computer from the projected screen
 - Operate the projector from the projected screen
 - Select devices on the projected screen that have been connected to the network using the supplied EasyMP Multi PC Projection
 - Use the interactive features over a network using the supplied EasyMP Network Projection or the optional Quick Wireless
- ☛ "Using the Interactive Features (EB-536Wi only)" p.58

The illustrations currently used in this guide are for the EB-536Wi.

Front/Top

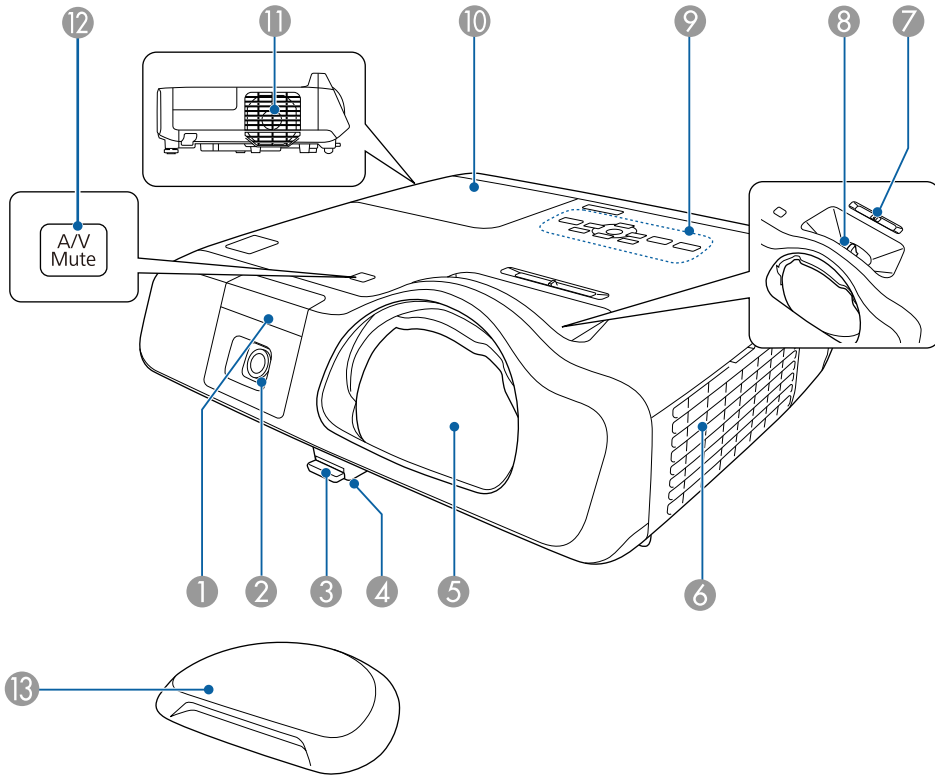

Name	Function
① Remote receiver	Receives signals from the remote control.
② Easy Interactive Function receiver (EB-536Wi only)	Receives signals from the interactive pen. ☛ "Using the Interactive Features (EB-536Wi only)" p.58

Name	Function
③ Foot adjust lever	Press the foot adjust lever to extend and retract the front adjustable foot. ☛ "Adjusting the Image Position" p.52
④ Front adjustable foot	When setup on a surface such as a desk, extend the foot to adjust the position of the image. ☛ "Adjusting the Image Position" p.52
⑤ Projection lens	Projects images.
⑥ Air intake vent (Air filter)	Takes in air to cool the projector internally. ☛ "Cleaning the Air Filter" p.163 ☛ "Replacing the Air Filter" p.169
⑦ Horizontal keystone adjuster (EB-536Wi only)	Corrects horizontal distortion in the projected image. ☛ "Correcting Manually" p.49
⑧ Focus ring	Adjusts the image focus. ☛ "Correcting the Focus" p.53
⑨ Control Panel	Operates the projector. ☛ "Control Panel" p.15
⑩ Lamp cover	Open when replacing the projector's lamp. ☛ "Replacing the Lamp" p.166

Name	Function
<p>⑪ Air exhaust vent</p>	<p>Exhaust vent for air used to cool the projector internally.</p> <div style="border: 1px solid black; padding: 5px; margin: 10px 0;"> <p>⚠ Warning</p> <p>Do not look into the vents. If the lamp explodes, gases may escape and small fragments of glass may be scattered which could cause an injury. Contact a doctor if any fragments of broken glass are inhaled or get into the eyes or mouth.</p> </div> <div style="border: 1px solid black; padding: 5px; margin: 10px 0;"> <p>⚠ Caution</p> <p>While projecting, do not put your face or hands near the air exhaust vent, and do not place objects that may become warped or damaged by heat near the vent.</p> </div>
<p>⑫ [A/V Mute] button</p>	<ul style="list-style-type: none"> • Turns the video and audio on or off. <ul style="list-style-type: none"> ☛ "Hiding the Image and Sound Temporarily (A/V Mute)" p.90 • Hold down the button for approximately three seconds to perform auto pen calibration (EB-536Wi only).
<p>⑬ Lens cover</p>	<p>Install when not using the projector to protect the lens from being damaged or soiled.</p>

Rear

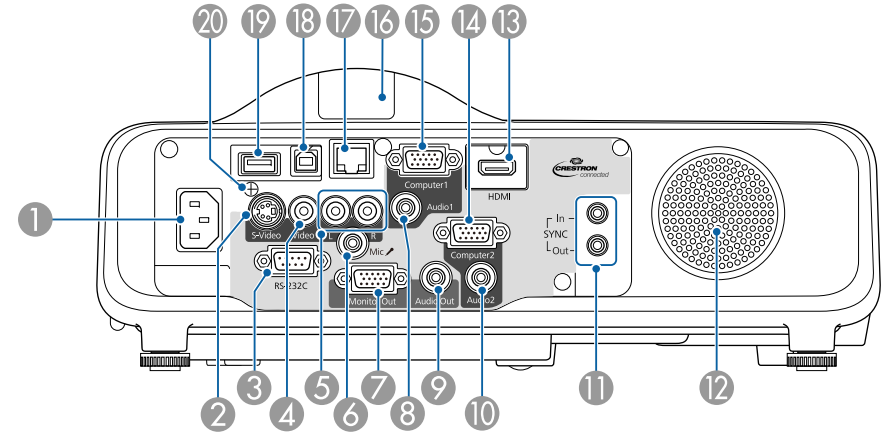

Name	Function
<p>① Power inlet</p>	<p>Connects the power cord to the projector.</p> <ul style="list-style-type: none"> ☛ "Turning On the Projector" p.41
<p>② S-Video port</p>	<p>For S-video signals from video sources.</p>
<p>③ RS-232C port</p>	<p>When controlling the device from a computer, connect it to the computer with an RS-232C cable. This port is for control use and should not normally be used.</p> <ul style="list-style-type: none"> ☛ "ESC/VP21 Commands" p.106
<p>④ Video port</p>	<p>Inputs composite video signals from video sources.</p>
<p>⑤ Audio-L/R port</p>	<p>Inputs audio from equipment connected to the S-Video port or the Video port.</p>
<p>⑥ Mic port</p>	<p>Inputs audio from the microphone.</p> <ul style="list-style-type: none"> ☛ "Connecting a Microphone" p.32
<p>⑦ Monitor Out port</p>	<p>Outputs analog RGB signals input from the Computer1 port to an external monitor. You cannot output signals input from other ports or component video signals.</p>
<p>⑧ Audio1 port</p>	<p>Inputs audio from equipment connected to the Computer1 port.</p>

Name	Function
9 Audio Out port	Outputs audio from the currently projected image to an external speaker.
10 Audio2 port	Inputs audio from equipment connected to the Computer2 port.
11 SYNC IN/OUT port (EB-536Wi only)	When installing multiple projectors in the same room and using the interactive function, connect projectors using the optional Remote control cable set (ELPKC28). Easy Interactive Pen operations are stabilized when connected. ☛ "Connecting Multiple Projectors (EB-536Wi only)" p.38
12 Speaker	Outputs audio.
13 HDMI port	Inputs video signals from HDMI compatible video equipment and computers. This projector is compatible with <u>HDCP</u> . ☛ "Connecting Image Sources" p.28
14 Computer2 port	Inputs image signals from a computer and component video signals from other video sources.
15 Computer1 port	
16 Remote receiver	Receives signals from the remote control.
17 LAN port	Connects a LAN cable to connect to a network.
18 USB-B port	<ul style="list-style-type: none"> Connects the projector to a computer using a USB cable, and projects the images on the computer. ☛ "Projecting with USB Display" p.45 Connects the projector to a computer using a USB cable to use the Wireless Mouse function. ☛ "Using the Remote Control to Operate the Mouse Pointer (Wireless Mouse)" p.93 When operating the mouse using the Easy Interactive Pen, connect to the computer with the supplied USB cable (EB-536Wi only). ☛ "Controlling a Computer from the Projected Screen (Computer Interactive Mode)" p.62

Name	Function
19 USB-A port	<ul style="list-style-type: none"> Connects a USB storage device or a digital camera, and projects images using PC Free. ☛ "Projecting Images Stored on a USB Storage Device (PC Free)" p.85 Connects the optional Document Camera. Connects the optional Wireless LAN unit. ☛ "Installing the Optional Wireless LAN Unit" p.36 Connects the optional Quick Wireless Connection USB Key. ☛ "Installing the Optional Quick Wireless Connection USB Key" p.37
20 Wireless LAN unit fixing screw	This screw secures the wireless LAN unit cover.

Base

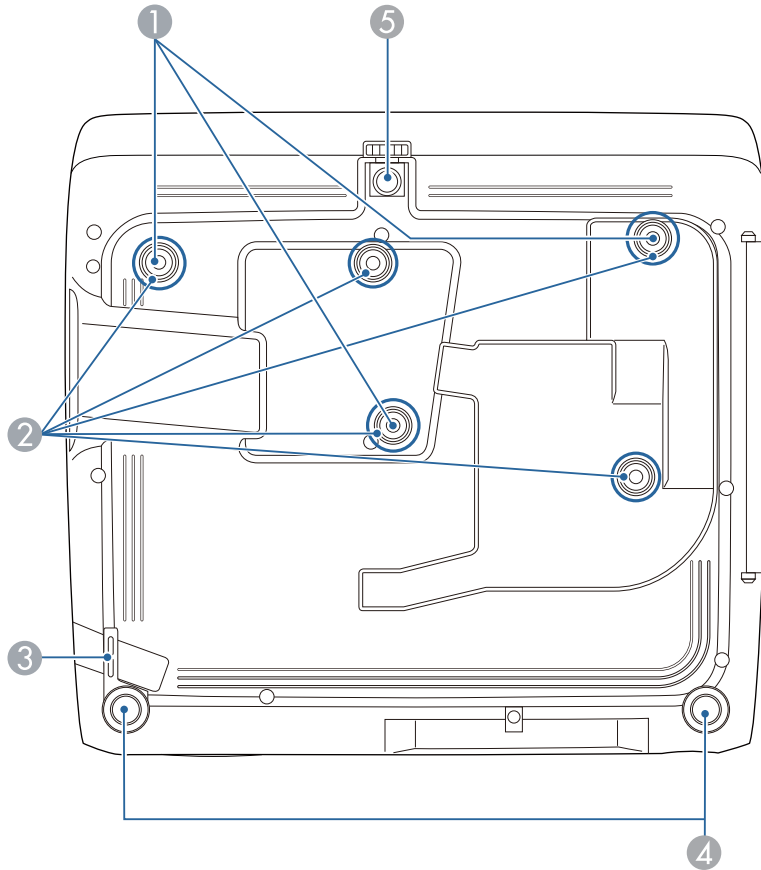

Name	Function
1 Ceiling mount fixing points (three points)	Attach the optional Ceiling mount here when suspending the projector from a ceiling. • "Installing the Projector" p.23 • "Optional Accessories" p.172

Name	Function
2 Wall mount plate fixing points (five points)	When attaching to a wall, attach the optional wall mount fixing plate. • "Optional Accessories" p.172
3 Security cable installation point	Pass a commercially available wire lock through here and lock it in place. • "Installing the Wire Lock" p.101
4 Rear feet	When setup on a surface such as a desk, turn to extend and retract to adjust the horizontal tilt. • "Adjusting the Horizontal Tilt" p.52
5 Front adjustable foot	When setup on a surface such as a desk, extend the foot to adjust the position of the image. • "Adjusting the Image Position" p.52

Control Panel

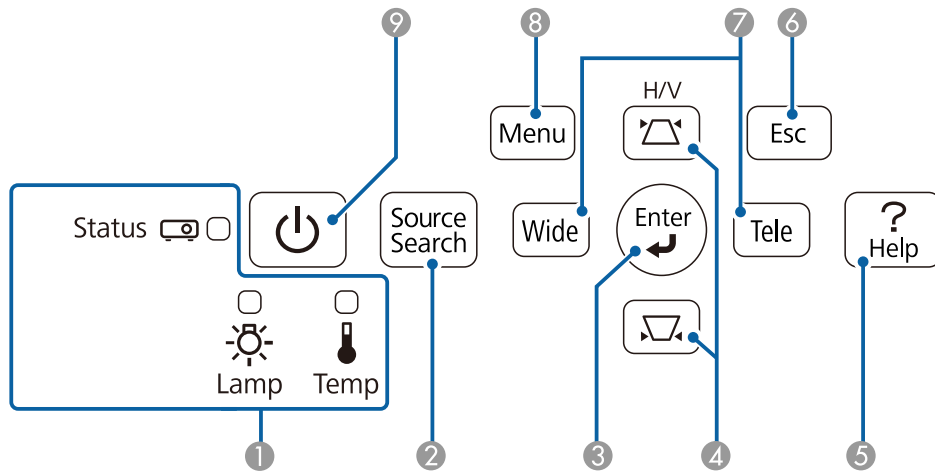



Name	Function
1 Indicators	Indicates the projector's status using color, and by being lit or flashing. ☛ "Reading the Indicators" p.143
2 [Source Search] button	Switches to the image from the input port where video signals are being input. ☛ "Automatically Detect Input Signals and Change the Projected Image (Source Search)" p.43
3 [Enter] button [↵]	<ul style="list-style-type: none"> When the Configuration menu or the Help screen is displayed, it accepts and enters the current selection and moves to the next level. If pressed while projecting analog RGB signals from the Computer1 port or Computer2 port, automatically optimizes the image by adjusting the Tracking, Sync., and Position.

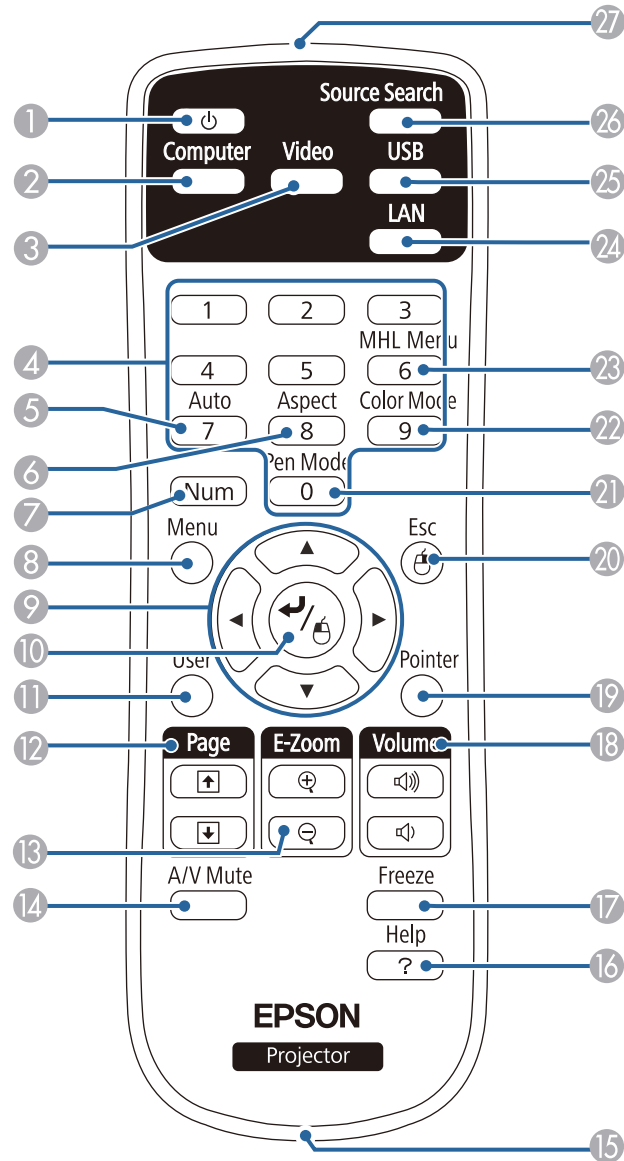

Name	Function
4 [△][▽] buttons	<ul style="list-style-type: none"> Perform keystone correction. <ul style="list-style-type: none"> ☛ "H/V-Keystone" p.49 If pressed when the Configuration menu or the Help screen is displayed, these buttons select menu items and setting values. <ul style="list-style-type: none"> ☛ "Using the Configuration Menu" p.113 ☛ "Using the Help" p.142
5 [Help] button	Displays and closes the Help screen which shows you how to deal with problems if they occur. ☛ "Using the Help" p.142
6 [Esc] button	<ul style="list-style-type: none"> Stops the current function. If pressed when the Configuration menu is displayed, it moves to the previous menu level. <ul style="list-style-type: none"> ☛ "Using the Configuration Menu" p.113
7 [Tele]/[Wide] buttons	<ul style="list-style-type: none"> Adjusts the size of the projection screen. Press the [Tele] button to reduce the size of the projection screen and press the [Wide] button to increase the size of the projection screen. Corrects keystone distortion in the horizontal direction when the Keystone screen is displayed. <ul style="list-style-type: none"> ☛ "H/V-Keystone" p.49 If pressed when the Configuration menu or the Help screen is displayed, these buttons select menu items and setting values. <ul style="list-style-type: none"> ☛ "Using the Configuration Menu" p.113 ☛ "Using the Help" p.142
8 [Menu] button	Displays and closes the Configuration menu. ☛ "Using the Configuration Menu" p.113
9 [Power] button [⏻]	Turns the projector power on or off. ☛ "Turning On the Projector" p.41

Remote Control



Name	Function
① [Power] button [⏻]	Turns the projector power on or off. ☛ "Turning On the Projector" p.41
② [Computer] button	Each time you press the button, the input changes between images from the Computer1 port and the Computer2 port.
③ [Video] button	Each time the button is pressed, the image cycles through the S-Video, Video, and HDMI ports.
④ Numeric buttons	<ul style="list-style-type: none"> Enter the Password. ☛ "Setting Password Protection" p.98 Use this button to enter numbers in Network settings from the Configuration menu.
⑤ [Auto] button	If pressed while projecting analog RGB signals from Computer1 port or Computer2 port, you can automatically optimize Tracking, Sync., and Position.
⑥ [Aspect] button	Each time the button is pressed, the aspect mode changes. ☛ "Changing the Aspect Ratio of the Projected Image" p.55
⑦ [Num] button	Hold down this button and press the numeric buttons to enter passwords and numbers. ☛ "Setting Password Protection" p.98
⑧ [Menu] button	Displays and closes the Configuration menu. ☛ "Using the Configuration Menu" p.113

	Name	Function
9	 buttons	<ul style="list-style-type: none"> When the Configuration menu or the Help screen is displayed, pressing these buttons selects menu items and setting values. <ul style="list-style-type: none"> "Using the Configuration Menu" p.113 When projecting using PC Free, pressing these buttons displays the previous/next image, rotates the image, and so on. <ul style="list-style-type: none"> "Projecting Images Stored on a USB Storage Device (PC Free)" p.85 During Wireless Mouse function, the mouse pointer moves in the direction of the button that was pushed. <ul style="list-style-type: none"> "Using the Remote Control to Operate the Mouse Pointer (Wireless Mouse)" p.93
10	[Enter] button 	<ul style="list-style-type: none"> When the Configuration menu or the Help screen is displayed, it accepts and enters the current selection and moves to the next level. <ul style="list-style-type: none"> "Using the Configuration Menu" p.113 Acts as a mouse's left button when using the Wireless Mouse function. <ul style="list-style-type: none"> "Using the Remote Control to Operate the Mouse Pointer (Wireless Mouse)" p.93
11	[User] button	<p>Select any frequently used item from the available Configuration menu items, and assign it to this button. By pressing the [User] button, the assigned menu item selection/adjustment screen is displayed, allowing you to make one-touch settings/adjustments.</p> <ul style="list-style-type: none"> "Settings Menu" p.119 <p>The following menu items are assigned by default.</p> <ul style="list-style-type: none"> For EB-536Wi: Auto Calibration For EB-535W/EB-525W/EB-530/EB-520: Power Consumption

	Name	Function
12	[Page] buttons 	<p>Changes pages in files such as PowerPoint files when using the following projection methods.</p> <ul style="list-style-type: none"> When using the Wireless Mouse function <ul style="list-style-type: none"> "Using the Remote Control to Operate the Mouse Pointer (Wireless Mouse)" p.93 When using USB Display <ul style="list-style-type: none"> "Projecting with USB Display" p.45 When connecting to a network <p>When projecting images using PC Free, pressing these buttons displays the previous/next screen.</p>
13	[E-Zoom] button 	<p>Enlarges or reduces the image without changing the projection size.</p> <ul style="list-style-type: none"> "Enlarging Part of the Image (E-Zoom)" p.92
14	[A/V Mute] button	<ul style="list-style-type: none"> Turns the video and audio on or off. <ul style="list-style-type: none"> "Hiding the Image and Sound Temporarily (A/V Mute)" p.90 You can change the Projection mode as follows by pressing the button for about five seconds. <ul style="list-style-type: none"> Front ↔ Front/UpSide Down Rear ↔ Rear/UpSide Down
15	Strap attachment hole	<p>Allows you to attach a commercially available strap to the remote control.</p>
16	[Help] button	<p>Displays and closes the Help screen which shows you how to deal with problems if they occur.</p> <ul style="list-style-type: none"> "Using the Help" p.142
17	[Freeze] button	<p>Images are paused or unpaused.</p> <ul style="list-style-type: none"> "Freezing the Image (Freeze)" p.91
18	[Volume] button 	<p>[<] Decreases the volume. [>] Increases the volume.</p> <ul style="list-style-type: none"> "Adjusting the Volume" p.53
19	[Pointer] button	<p>Displays the on-screen pointer.</p> <ul style="list-style-type: none"> "Pointer Function (Pointer)" p.91

Name	Function
20 [Esc] button	<ul style="list-style-type: none"> Stops the current function. If pressed when the Configuration menu is displayed, it moves to the previous level. <ul style="list-style-type: none"> "Using the Configuration Menu" p.113 Acts as a mouse's right button when using the Wireless Mouse function. <ul style="list-style-type: none"> "Using the Remote Control to Operate the Mouse Pointer (Wireless Mouse)" p.93
21 [Pen Mode] button	<p>(Only available in EB-536Wi)</p> <p>Changes between operating the computer or drawing using the interactive pen.</p> <ul style="list-style-type: none"> "Using the Interactive Features (EB-536Wi only)" p.58
22 [Color Mode] button	<p>Each time the button is pressed, the color mode changes.</p> <ul style="list-style-type: none"> "Selecting the Projection Quality (Selecting Color Mode)" p.53
23 [MHL Menu] button	Not available on this device.
24 [LAN] button	Switches to the image from the network connected device.
25 [USB] button	<p>Each time the button is pressed, it cycles through the following images:</p> <ul style="list-style-type: none"> USB Display Images from the device connected to the USB-A port
26 [Source Search] button	<p>Switches to the image from the input port where video signals are being input.</p> <ul style="list-style-type: none"> "Automatically Detect Input Signals and Change the Projected Image (Source Search)" p.43
27 Remote control light-emitting area	Outputs remote control signals.

Replacing the Remote Control Batteries

If the remote control becomes unresponsive or inoperable after it has been used for some time, the batteries may have reached the end of their service life. When this happens, replace them with new batteries. Obtain two AA size manganese or alkaline batteries. You cannot use other batteries except for the AA size manganese or alkaline.

Attention

Make sure you read the following manual before handling the batteries.

 [Safety Instructions](#)

1 Remove the battery cover.

While pushing the battery cover catch, lift the cover up.

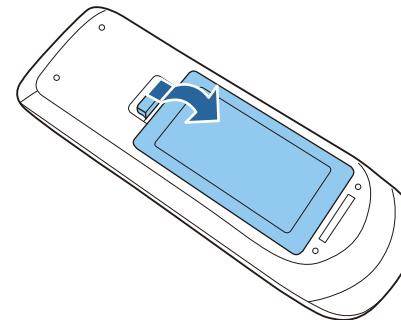

2 Replace the old battery with a new battery.

Slide the batteries in negative side first.

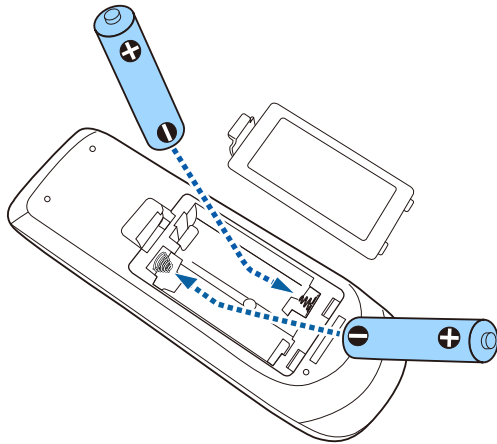

Caution

Check the positions of the (+) and (-) marks inside the battery holder to ensure the batteries are inserted the correct way.
If the batteries are not used correctly, they could explode or leak causing a fire, injury, or damage to the product.

- 3 Replace the battery cover.
Press the battery cover until it clicks into place.

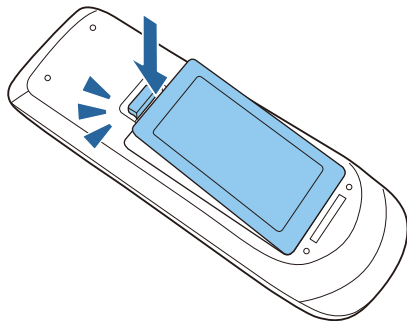

Remote Control Operating Range

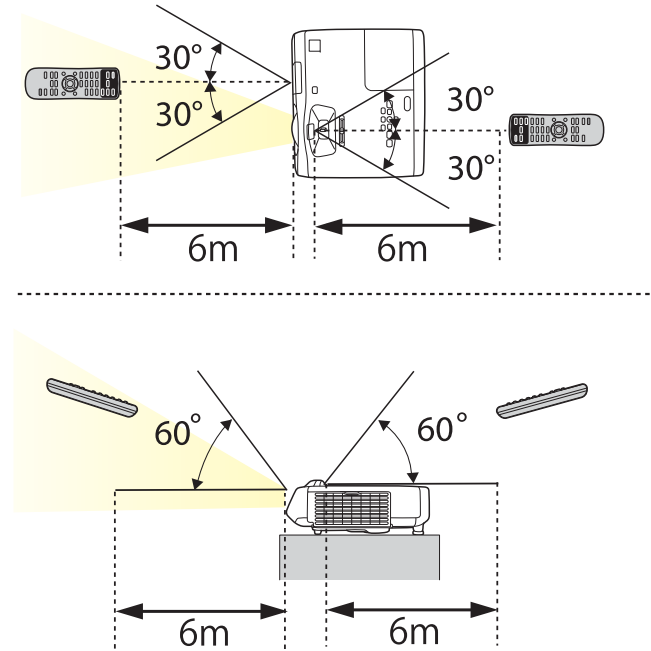

Easy Interactive Pen (EB-536Wi only)

There are two types of interactive pens with different colored bottom sections. You cannot use interactive pens with the same colored bottom sections at the same time.

☛ "Optional Accessories" [p.172](#)

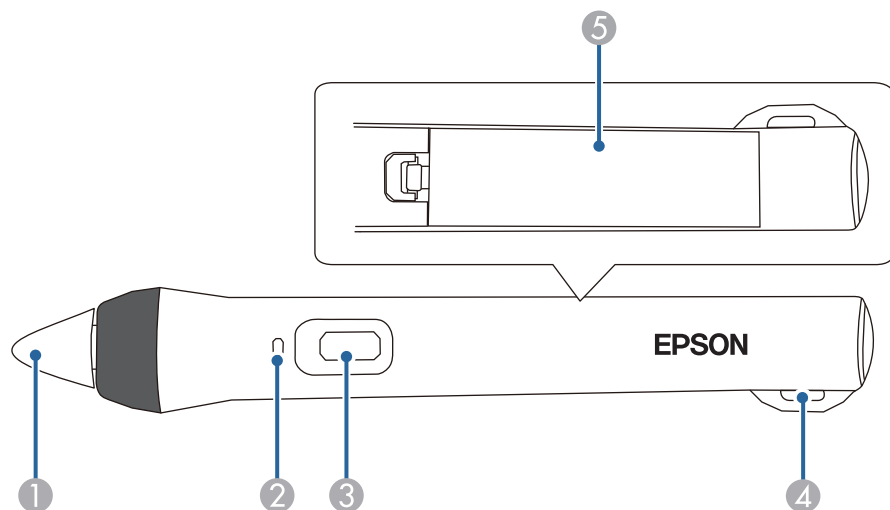

Name	Function
1 Pen Tip	<ul style="list-style-type: none"> • Turn on the interactive pen. When turned on, it takes approximately one second before the interactive pen is operational. • Hold the pen close to the projected image, and press to use. <p>☛ "Using the Interactive Features (EB-536Wi only)" p.58</p> <p>☛ "Optional Accessories" p.172</p>
2 Battery light	<p>Press the button on the side of the pen to indicate the remaining battery power.</p> <ul style="list-style-type: none"> • When the battery is charged, the light is lit green until you release the button. • When the battery is running low, the light flashes green until you release the button. • Does not light when the battery is exhausted. Change the batteries. <p>☛ "Replacing the Battery for the Interactive Pen" p.20</p>
3 Button	<p>Turn on the interactive pen. When turned on, it takes approximately one second before the interactive pen is operational.</p>

Name	Function
4 Attachment for optional strap or cord	<p>Allows you to attach a commercially available strap.</p>
5 Battery cover	<p>Open this cover when replacing the battery.</p> <p>☛ "Replacing the Battery for the Interactive Pen" p.20</p>



The interactive pen turns off automatically after 20 minutes of inactivity.

To use the pen again, tap the pen tip or press the button on the side to turn on the power.

Replacing the Battery for the Interactive Pen

When you press the button, the battery light on the interactive pen lights or flashes. Does not light or flash when the battery is exhausted. When the light no longer lights or flashes, replace the battery. Use one of the following types of battery. Other chargeable batteries cannot be used.

- AA size manganese battery
 - AA size alkaline manganese battery
 - eneloop®*(HR-3UTG/HR-3UTGA/HR-3UTGB/BK-3MCC)
- *eneloop® is a registered trademark of the Panasonic Group.

Attention

Make sure you read the following manual before handling the batteries.

☛ [Safety Instructions](#)

- 1** Remove the battery cover.
While pushing the battery cover catch, lift the cover up.

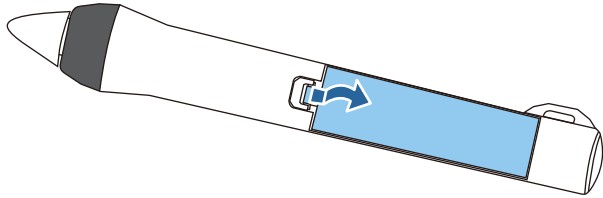

- 2** Replace the old battery with new battery.
Slide the battery in negative side first.

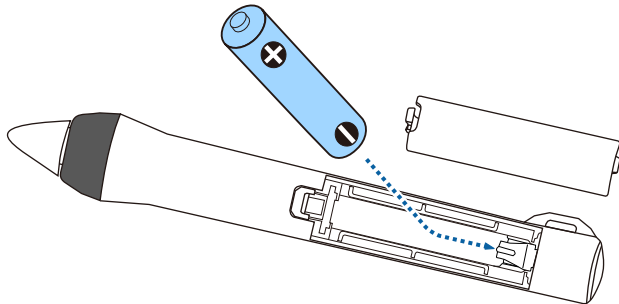

Caution

Check the positions of the (+) and (-) marks inside the battery holder to ensure the battery is inserted the correct way.

If the batteries are not used correctly, they could explode or leak causing a fire, injury, or damage to the product.

- 3** Replace the battery cover.
Press the battery cover until it clicks into place.

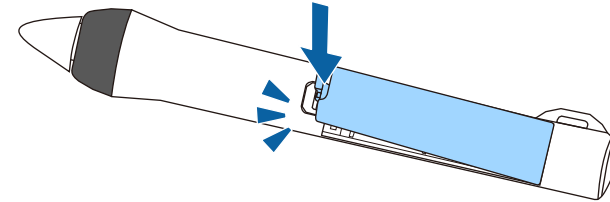

Replacing the Tip of the Interactive Pen

Replace the tip of the interactive pen when it is worn.

 "Optional Accessories" [p.172](#)

- 1** Turn the tip of the pen to remove it.

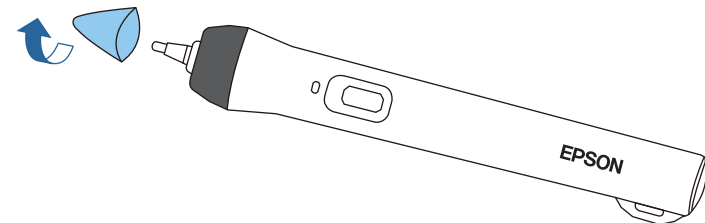

- 2** Turn the new tip to attach it.

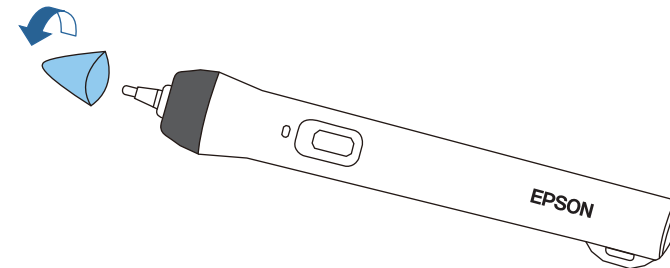



Preparing the Projector

This chapter explains how to install the projector and connect projection sources.

Installation Methods

The projector supports the following four different projection methods. Install the projector according to the conditions of the installation location.

Turn the projector off when installing the projector or changing the installation method. Turn the power back on after completing installation.

- Project images from in front of the screen. (Front projection)

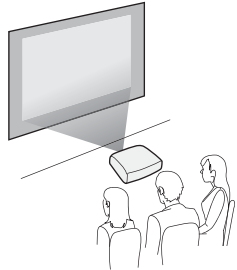

- Project images from behind a translucent screen. (Rear projection)

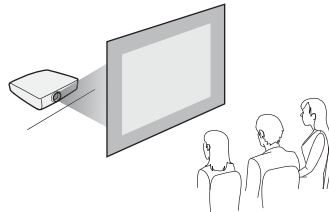

- Suspend the projector from a wall or ceiling and project images from in front of a screen. (Front/Ceiling projection)

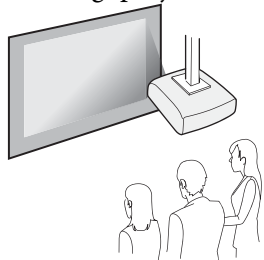

- Suspend the projector from the ceiling and project images from behind a translucent screen. (Rear/Ceiling projection)

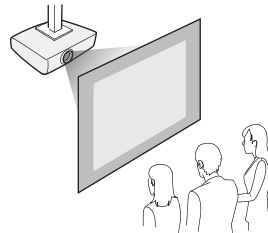

Warning

- A special method of installation is required when suspending the projector from a wall or ceiling. If it is not installed correctly, it could fall causing an accident and injury.
- If you use adhesives on the wall mount plate fixing points or the ceiling mount fixing points to prevent the screws from loosening, or if you use things such as lubricants or oils on the projector, the projector case may crack causing it to fall from its mount. This could cause serious injury to anyone under the mount and could damage the projector. When installing or adjusting the mount, do not use adhesives to prevent the screws from loosening and do not use lubricant or oil and so on.
- Do not cover the projector's air intake vent or air exhaust vent. If either of the vents are covered, the internal temperature could rise and cause a fire.
- Do not use the projector in a location subject to combustible or explosive gas. The projector may catch fire due to the high internal temperature of the lamp.

Attention

Do not use the projector on its side. This may cause malfunctions to occur.



- We recommend using a smooth, board type screen without any unevenness. If the projection screen is uneven, there may be distortions in the projected image.
- Distortions may occur in the projected image depending on the material of the screen and the installation method.
- When installing the projector on a wall or on the ceiling, make sure you use the correct tools for the installation method.
 - ☛ "Optional Accessories" [p.172](#)
- The default Projection setting is **Front**. You can change from **Front** to **Rear** from the Configuration menu.
 - ☛ **Extended - Projection** [p.120](#)
- You can change the Projection mode as follows by pressing down the [A/V Mute] button on the remote control for about five seconds.
Front ↔ Front/Ceiling
Rear ↔ Rear/Ceiling

Installation Methods

Install the projector as follows.

- Install the projector so that it is parallel to the screen.
If the projector is installed at an angle to the screen, keystone distortion occurs in the projected image.

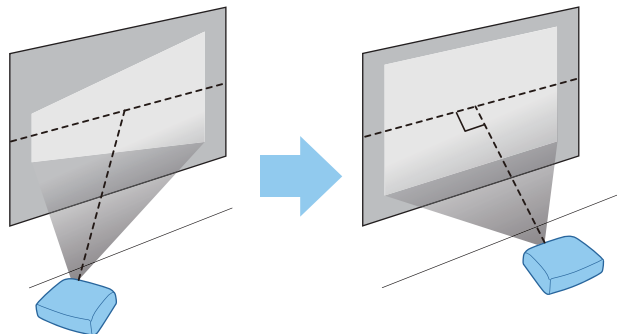

- Place the projector on a level surface.
If the projector is tilted the projected image is also tilted.

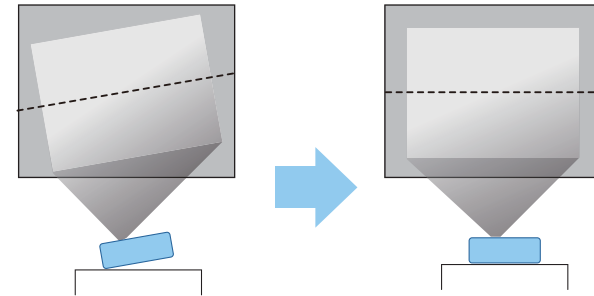

- See the following if you cannot install the projector parallel to the screen.
 - ☛ "Correcting Keystone Distortion" [p.48](#)
- See the following if you cannot install the projector on a level surface.
 - ☛ "Adjusting the Horizontal Tilt" [p.52](#)
 - ☛ "Correcting Keystone Distortion" [p.48](#)

When Using the Interactive Features (EB-536Wi only)

Project from in front of the screen when using the interactive features. Set the Projection mode to **Front** or **Front/Ceiling**.

Install the projector so that the angle of tilt is $\pm 7^\circ$ vertically and $\pm 5^\circ$ horizontally against the projection side.

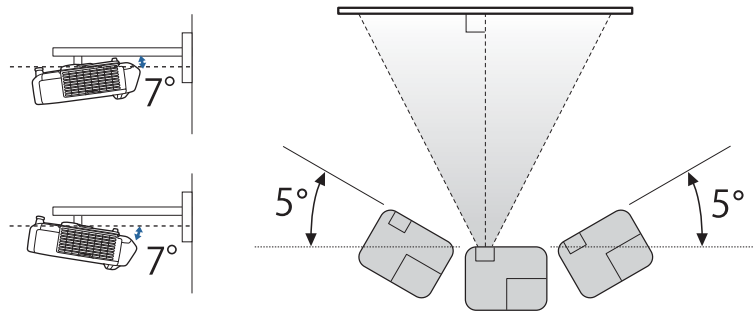

Attention

The interactive features operate by infrared communication. Note the following points when installing the projector.

- Make sure there is no strong light or sunlight shining on the Easy Interactive Function receiver, the projection screen, the projector itself, or the rear of the projector.
- Do not install the projector in direct sunlight through a window. This could cause the interactive features to malfunction.
- If there is any dust stuck to the Easy Interactive Function receiver, it could interfere with infrared communication and you may not be able to use the function normally. Clean the receiver if it is dirty.
- Do not put paint or any stickers on the cover of the Easy Interactive Function receiver.
- Install the projector so that the Easy Interactive Function receiver is not too close to fluorescent lights. If the surrounding area is too bright, the interactive features may not operate correctly.
- When using the interactive features, do not use an infrared remote control or microphone in the same room. The Easy Interactive Pen could malfunction.
- Do not use devices that generate powerful noise, such as rotary devices or transformers, near the projector. You may not be able to operate the interactive features.



- When using the interactive features, install so that the projected screen is a rectangle without any distortion.
- When using the interactive features in the same room as multiple projectors, Easy Interactive Pen operations may become unstable. In this situation, connect the optional Remote control cable set (ELPKC28) to the projectors, and change **Sync of Projectors** to **Wired** from the Configuration menu.
- ☛ "Connecting Multiple Projectors (EB-536Wi only)" [p.38](#)
- ☛ **Extended - Easy Interactive Function - General - Advanced - Sync of Projectors** [p.123](#)

The port name, location, and connector orientation differ depending on the source being connected.

Connecting a Computer

To project images from a computer, connect the computer using one of the following methods.

1 When using the supplied or optional computer cable

Connect the computer's display output port to the projector's Computer1 or Computer2 port. You can output audio from the projector's speaker by connecting the computer's audio output port to the projector's Audio1 or Audio2 port using a commercially available audio cable.

2 When using the supplied or commercially available USB cable

Connect the computer's USB port to the projector's USB-B port. Audio from the computer is output from the projector with the projected image.

3 When using a commercially available HDMI cable

Connect the computer's HDMI port to the projector's HDMI port. Audio from the computer is output from the projector with the projected image.

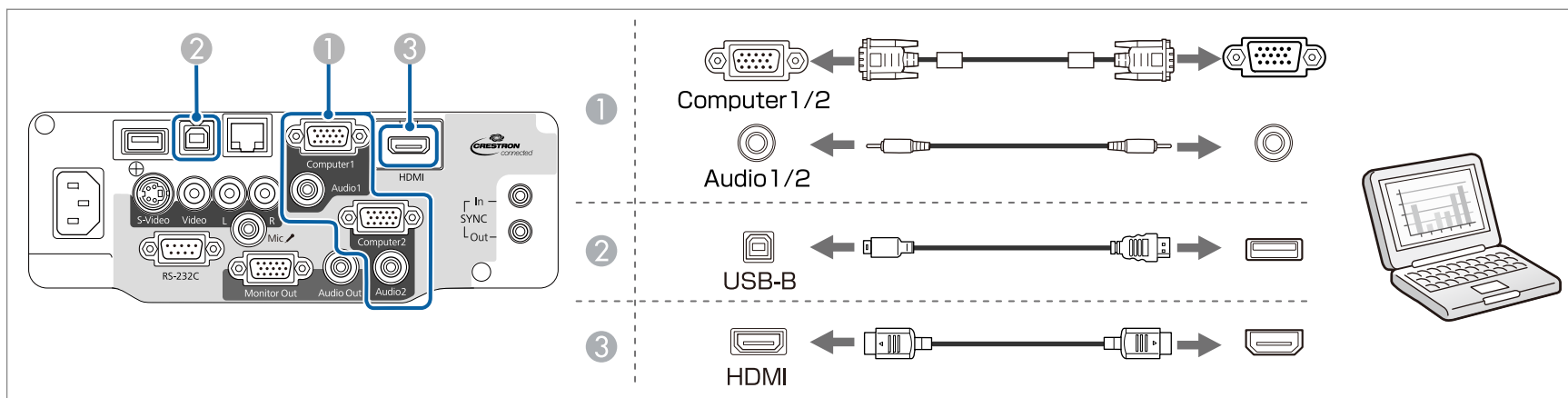



- You can also set the port used for audio input from the Configuration menu.
 - ☛ **Extended - A/V Settings - Audio Output** [p.120](#)
- If audio is not output when an HDMI cable is connected, connect a commercially available audio cable to the audio input port. After connecting the cable, select the input port you connected to from **HDMI Audio Output** from the Configuration menu.
 - ☛ **Extended - A/V Settings - HDMI Audio Output** [p.120](#)
- You can use a USB cable to connect the projector to a computer to project images from the computer. This function is called USB Display.
 - ☛ "Projecting with USB Display" [p.45](#)

Connecting Image Sources

To project images from DVD players or VHS video and so on, connect to the projector using one of the following methods.

1 When using a commercially available video or S-video cable

Connect the video output port on the image source to the projector's Video port. Or, connect the S-video output port on the image source to the projector's S-Video port. You can output audio from the projector's speaker by connecting the audio output port on the image source to the projector's Audio-L/R port using a commercially available audio cable.

2 When using the optional component video cable

☛ "Optional Accessories" p.172

Connect the component output port on the image source to the projector's Computer1 or Computer2 port. You can output audio from the projector's speaker by connecting the audio output port on the image source to the projector's Audio1 or Audio2 port using a commercially available audio cable.

3 When using a commercially available HDMI cable

Connect the HDMI port on the image source to the projector's HDMI port. Audio from the image source is output from the projector with the projected image.

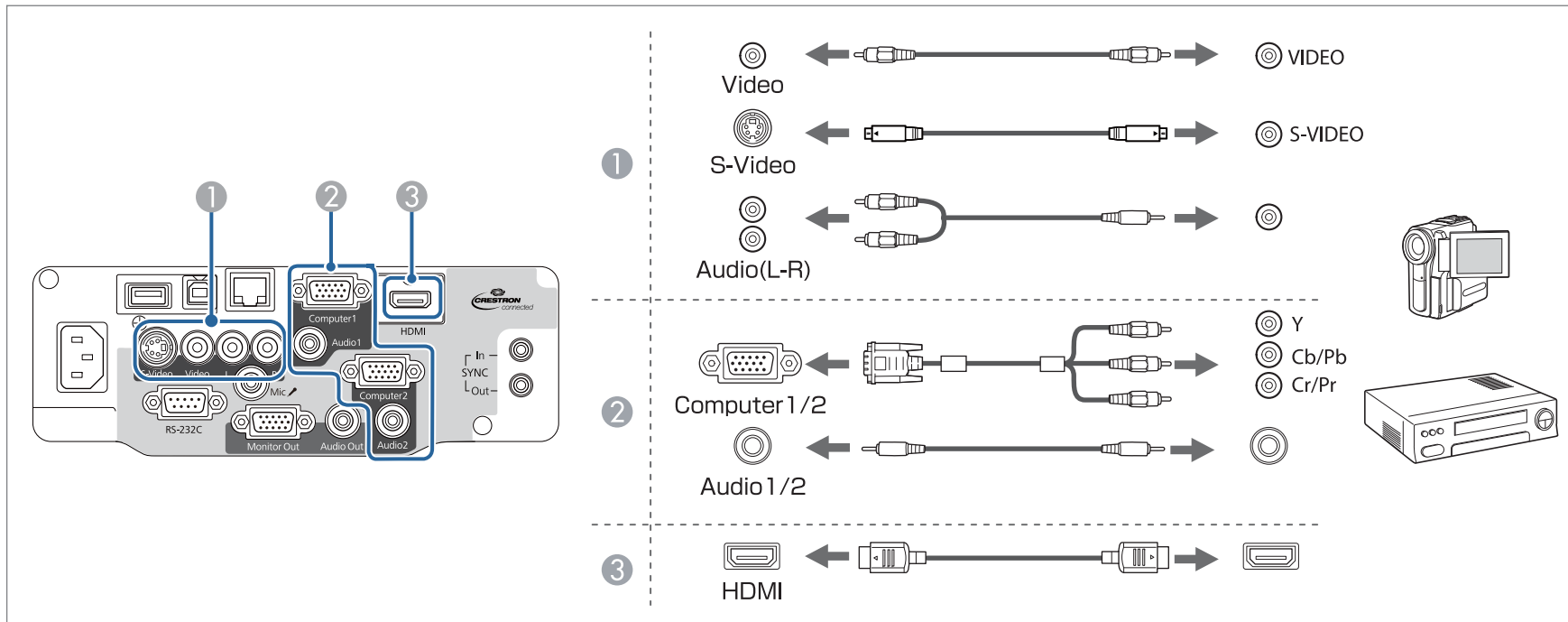

Attention

- Turn off the equipment you want to connect before connecting. If the input source is on when you connect it to the projector, it could cause a malfunction.
- If the orientation or shape of the plug differs, do not try to force it in. The device could be damaged or could malfunction.



- You can also set the port used for audio input from the Configuration menu.
 - ☛ **Extended - A/V Settings - Audio Output** [p.120](#)
- If audio is not output when an HDMI cable is connected, connect a commercially available audio cable to the audio input port. After connecting the cable, select the input port you connected to from **HDMI Audio Output** from the Configuration menu.
 - ☛ **Extended - A/V Settings - HDMI Audio Output** [p.120](#)
- If the source you want to connect to has an unusually shaped port, use the cable supplied with the device or an optional cable to connect to the projectors.
- When using a commercially available 2RCA(L/R)/stereo mini-pin audio cable, make sure it is labeled "No resistance".

Connecting USB Devices

You can connect devices such as USB memory, the optional Document Camera, and USB compatible hard disks and digital cameras. Using the USB cable supplied with the USB device, connect the USB device to the USB-A port on the projector.

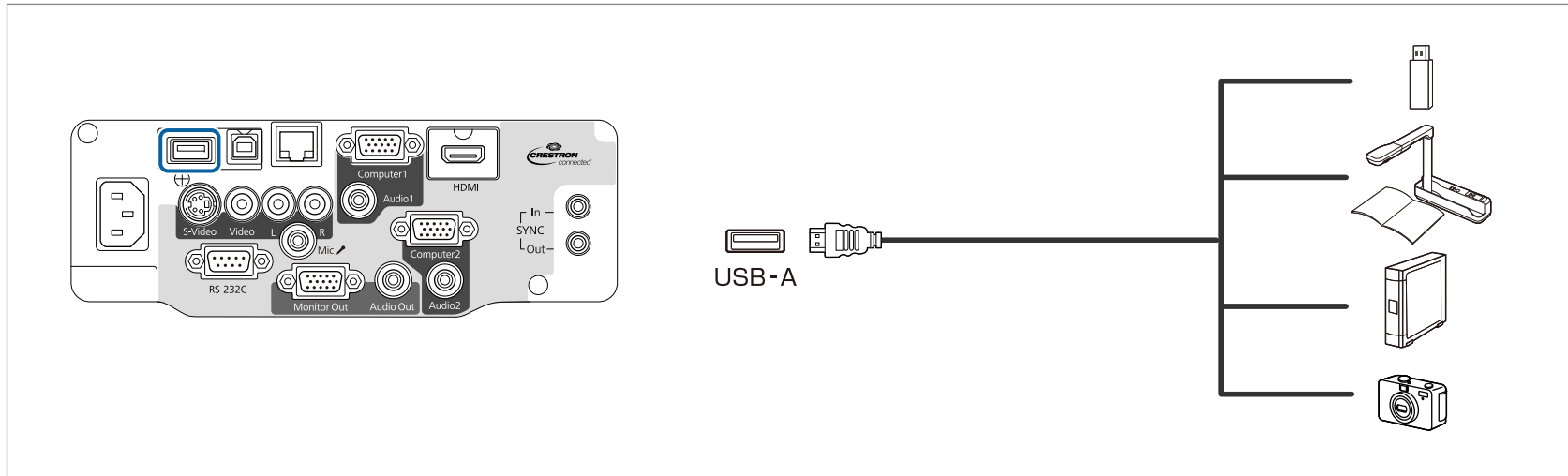

When the USB device is connected, you can project image files on the USB memory or digital camera using PC Free.

☛ "Projecting Images Stored on a USB Storage Device (PC Free)" [p.85](#)

If the Document Camera is connected while projecting images from another input port, press the [USB] button on the remote control, or the [Source Search] button on the control panel, to switch to images from the Document Camera.

☛ "Automatically Detect Input Signals and Change the Projected Image (Source Search)" [p.43](#)



- While projecting images from a USB device, if you want to connect an audio output device, connect it to the Audio2 port.
- You can also set the port used for audio input from the Configuration menu.
 - ☛ **Extended - A/V Settings - Audio Output** [p.120](#)



Attention

- If you use a USB hub, operation may not be performed correctly. Devices such as digital cameras and USB devices should be connected to the projector directly.
- When connecting and using a USB-compatible hard disk, make sure you connect the AC adaptor supplied with the hard disk.
- Connect a digital camera or hard disk to the projector using a USB cable supplied with or specified for use with the device.
- Use a USB cable less than three meters in length. If the cable exceeds 3 m, PC Free may not function correctly.

Removing USB Devices

After finishing projecting, remove USB devices from the projector. For devices such as digital cameras or hard disks, turn off the device and then remove it from the projector.

Connecting a Microphone

You can output microphone audio from the projector's speaker by connecting a commercially available dynamic microphone.

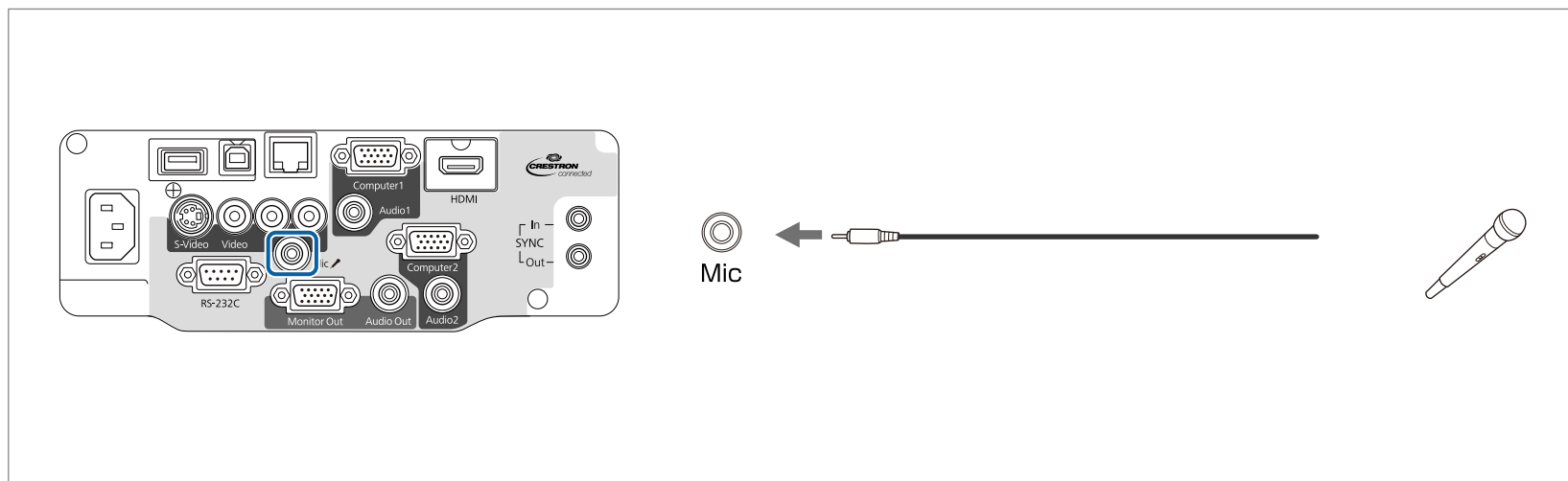

- Plug-in-power is not supported.
- Adjust **Mic Input Level** if the microphone audio is difficult to hear, or if it is too loud resulting in a crackling sound.
 - ☛ **Settings - Mic Input Level** [p.119](#)
- Make the following settings to output audio from a microphone when the projector is off.
 - Set **Standby Mode** to **Communication On**.
 - Set **A/V Output** to **Always On**.
 - ☛ **ECO - Standby Mode** [p.133](#)
 - ☛ **Extended - A/V Settings - A/V Output** [p.120](#)

Connecting External Equipment

You can output images and audio by connecting an external monitor or speaker.

1 When outputting images to an external monitor



Connect the external monitor to the projector's Monitor Out port using the cable supplied with the external monitor.

2 When outputting audio to an external speaker

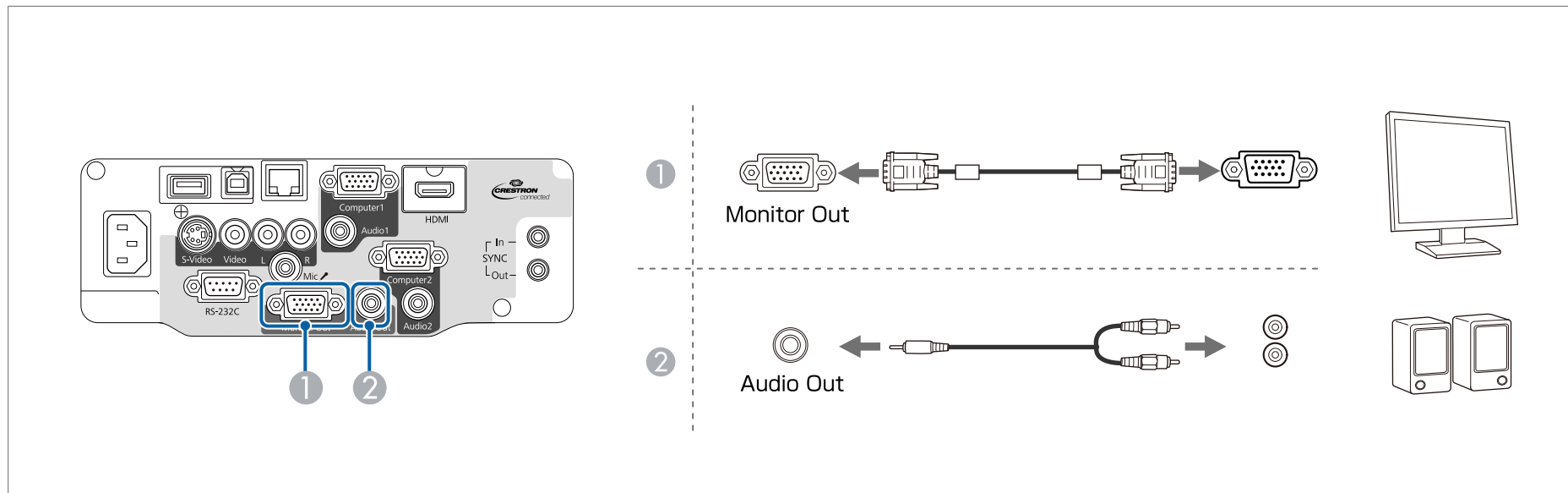
Connect the external speaker to the projector's Audio Out port using a commercially available audio cable.





- When **Standby Mode** is set to **Communication On**, you can perform the following operations even when the projector is off (only when **A/V Output** is set to **Always On**).
 - Output images to an external monitor
 - Output audio (audio being input from the USB-A, USB-B, or LAN ports cannot be output)
-  **ECO - Standby Mode** [p.133](#)
-  **Extended - A/V Settings - A/V Output** [p.120](#)
- Only analog RGB signals from the Computer1 port can be output to an external monitor. You cannot output signals input from other ports or component video signals.
- Setting gauges for functions such as Keystone, Configuration Menu, or Help screens are not output to the external monitor.
- Content drawn using the interactive features is not displayed on an external monitor (EB-536Wi only). Content drawn using the supplied Easy Interactive Tools can be displayed on an external monitor.
- When the audio cable jack is inserted into the Audio Out port, audio stops being output from the projector's built-in speakers and switches to external output.

Connecting a LAN Cable

Connect a LAN port on network hubs or other equipment to the projector's LAN port with a commercially available 100BASE-TX or 10BASE-T LAN cable.

By connecting a computer to the projector over a network, you can project images and check the status of the projector.

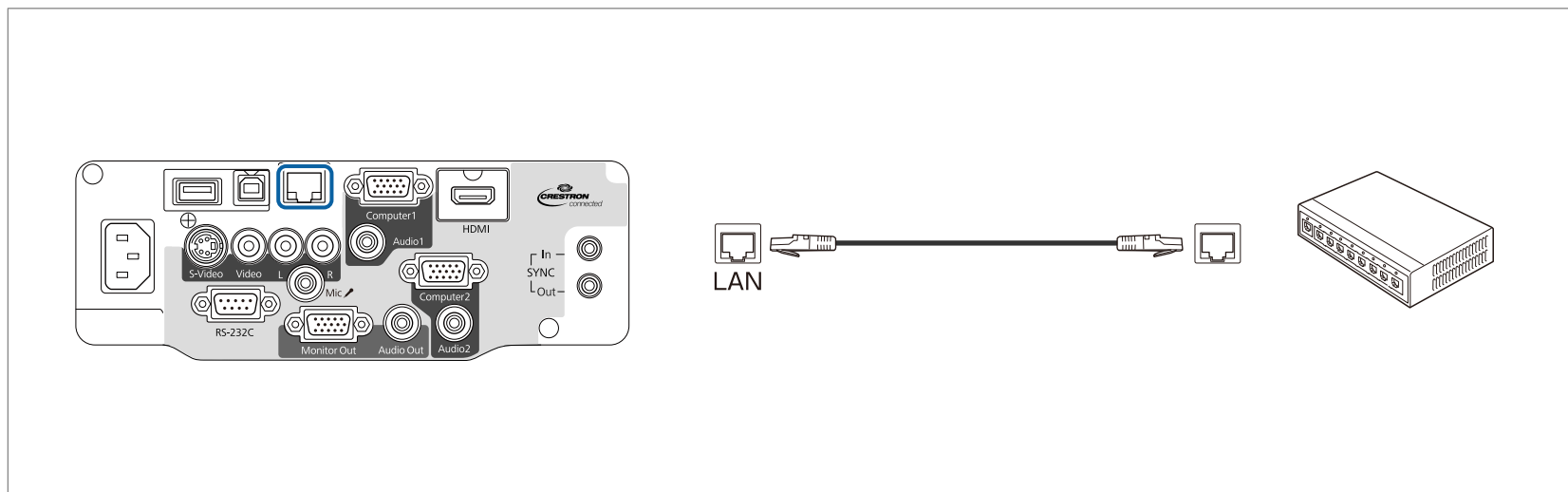

To prevent malfunctions, use a category 5 or higher shielded LAN cable.

Installing the Optional Wireless LAN Unit

By installing the optional Wireless LAN unit, you can project a computer screen over a network.

Connect the Wireless LAN unit to the projector's USB-A port.



- When connecting to the network using wireless LAN, make sure you make network settings from the Configuration menu.
 - ☛ "Wireless LAN Menu" [p.127](#)
- If you normally leave the Wireless LAN unit installed, make sure you attach the supplied wireless LAN unit cover as a theft deterrent.
- When moving the projector, make sure you remove the Wireless LAN unit and cover for safety reasons.

- 1** Use a cross-head screwdriver to remove the screw that secures the wireless LAN unit cover.

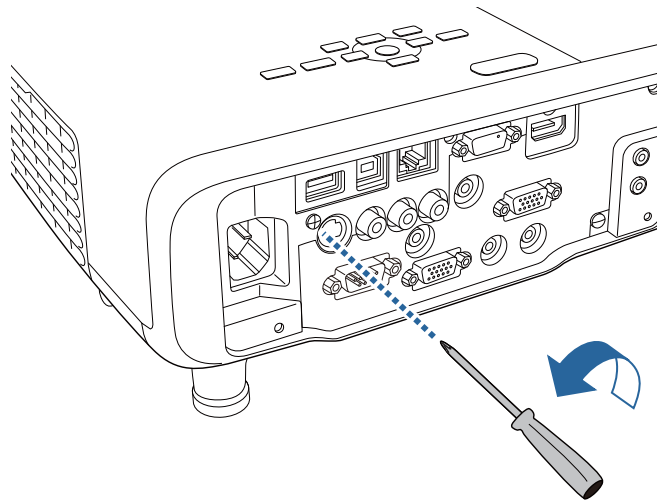

- 2** Connect the Wireless LAN unit to the USB-A port.

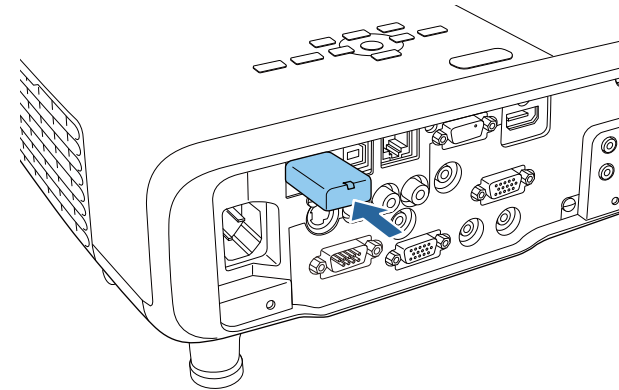

- 3** Attach the wireless LAN unit cover, and secure it in place with the screw.

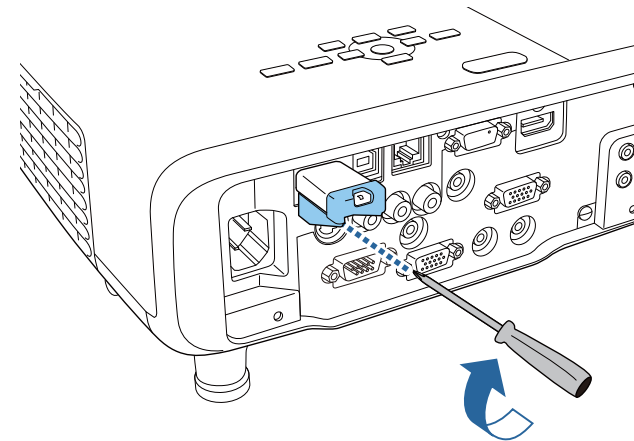

Installing the Optional Quick Wireless Connection USB Key

When installing the optional Quick Wireless Connection USB Key, you need to remove the Wireless LAN unit first, and then connect the Quick Wireless Connection USB Key to the USB-A port.

- 1** Turn on the projector, and then press the [LAN] button on the remote control.

The LAN standby screen is displayed.

- 2** Check that the SSID and IP address information are displayed on the LAN standby screen, and then remove the Wireless LAN unit.

- 3** Connect the Quick Wireless Connection USB Key to the USB-A port.

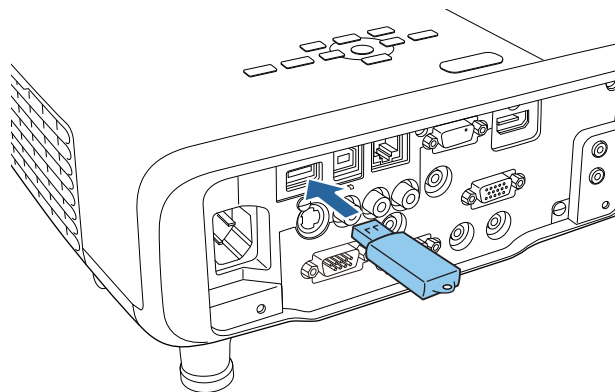

- 4** When the message "Network information update complete. Remove the Quick Wireless Connection USB Key Adapter." is displayed, remove the Quick Wireless Connection USB Key.

- 5** Reinstall the Wireless LAN unit on the projector.

- 6** Connect the Quick Wireless Connection USB Key to the computer you are using.

For the steps from here on, see the User's Guide supplied with the Quick Wireless Connection USB Key.

Connecting Multiple Projectors (EB-536Wi only)

When using the interactive features in the same room as multiple versions of the same projector, you need to connect the optional Remote control cable set (ELPKC28) to the SYNC port on each projector. Interactive pen operations are stabilized by linking the projectors using cables.

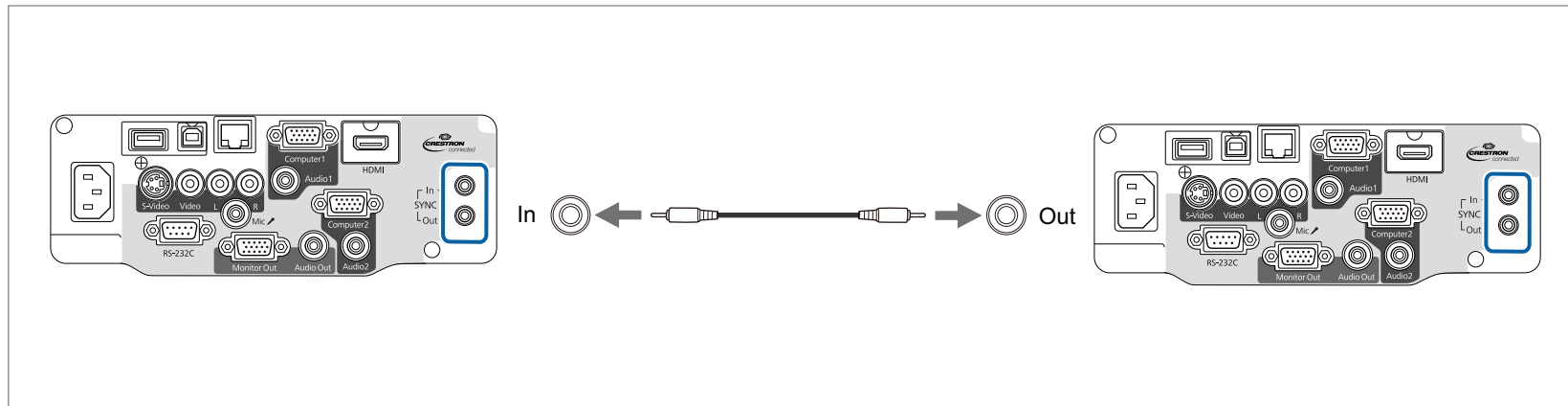

The SYNC port has an IN and OUT socket. When you connect one end of the Remote control cable set to an IN socket, connect the other end to an OUT socket.

After connecting the cables, set **Sync of Projectors** to **Wired** from the Configuration menu.

☛ **Extended - Easy Interactive Function - General - Advanced - Sync of Projectors** [p.123](#)



- When connecting three or more projectors, you do not need to connect the first projector to the last projector.

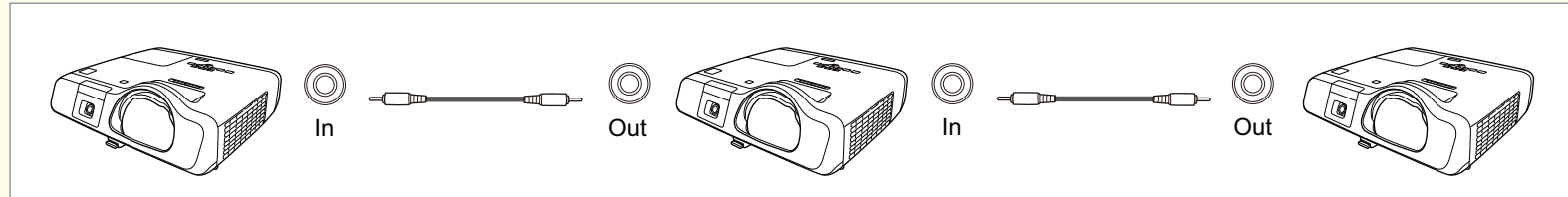

- When using the projector in the same room as another projector that does not support cable connection, set **Wired Sync Mode** to **Mode 2** from the Configuration menu.
 - ☛ **Extended - Easy Interactive Function - General - Advanced - Wired Sync Mode** [p.123](#)
- If you do not have the optional Remote control cable set, change the **Distance of Projectors** setting from the Configuration menu.
 - ☛ **Extended - Easy Interactive Function - General - Advanced - Distance of Projectors** [p.123](#)



Basic Usage

This chapter explains how to project and adjust images.

Turning On the Projector

Connect the computer or video equipment you want to use with the projector before you turn on the projector.

☛ "Connecting Equipment" [p.26](#)

- 1** Remove the lens cover.
- 2** Connect the projector to an electrical outlet with the power cord.

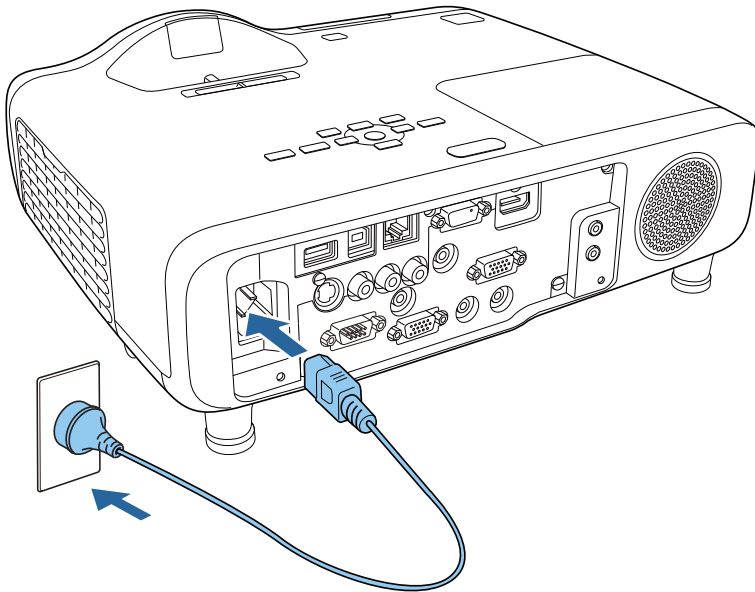

The projector's power indicator turns blue (standby status). In standby status, power is being supplied to the projector, however it is not turned on.

- 3** Press the [⏻] power button on the control panel or the remote control to turn on the projector.

Check that a beep sounds and the status indicator flashes blue (warm-up status). When warm-up is complete, the status indicator stops flashing and remains blue.

Try one of the following if the image is not projected.

- Turn on the connected computer or video device.
- Change the screen output from the computer when using a laptop computer.
- Insert a DVD or other video media, and press play (if necessary).
- Press the [Source Search] button on the control panel or the remote control to detect the input sources.
 - ☛ "Automatically Detect Input Signals and Change the Projected Image (Source Search)" [p.43](#)
- On the remote control, press the button the corresponds to the source.
 - ☛ "Switching to the Target Image Using the Remote Control" [p.44](#)

Warning

- Do not look into the projector's lens during projection. Doing so could damage your eyes. Take particular care when there are children present.
- During projection, do not block the light from the projector with the lens cover or a book and so on. If the light from the projector is blocked, the area on which the light shines becomes hot which could cause the lens cover to melt, burn, or start a fire. Also, the lens may get hot due to the reflected light which could cause the projector to malfunction. To stop projection, use the A/V Mute function, or turn off the projector.
- A mercury lamp with high internal pressure is used as the projector's light source. If the lamp is subjected to vibrations, shocks, or if it is used for an overly extended length of time, the lamp may break or it may not turn on. If the lamp explodes, gases may escape and small fragments of glass may be scattered which could cause an injury. Be sure to observe the instructions below.
 - Do not disassemble or damage the lamp or subject it to any impacts.
 - Do not bring your face close to the projector while it is in use.
 - Particular care should be taken when the projector is installed to a ceiling, as small pieces of glass may fall down when the lamp cover is removed. (When cleaning the projector or replacing the lamp yourself, be very careful not to allow such pieces of glass to get into the eyes or mouth.)
 If the lamp breaks, ventilate the area immediately, and contact a doctor if any fragments of broken glass are inhaled or get into the eyes or mouth.



- When **Direct Power On** is set to **On** from the **Extended** menu, the projector turns on automatically when the power cord is connected. When the power cord is plugged in, note that the projector turns on automatically in cases such as a power outage being restored.
 - ☛ **Extended - Operation - Direct Power On p.120**
- When **Auto Power On** is set to **Computer1** in the **Extended** menu, when an image signal is being input into the projector's Computer1 input port, the power turns on automatically. (Only when **Standby Mode** is set to **Communication On** in the ECO menu.)
 - ☛ **Extended - Operation - Auto Power On p.120**

Turning Off the Projector



Turn off this product when it is not in use to prolong the life of the projector. The lamp's operating life changes depending on the Configuration menu settings, environmental conditions, and usage. Brightness decreases over time.

- 1 Press the [⏻] button on the control panel or the remote control. The shutdown confirmation screen is displayed.

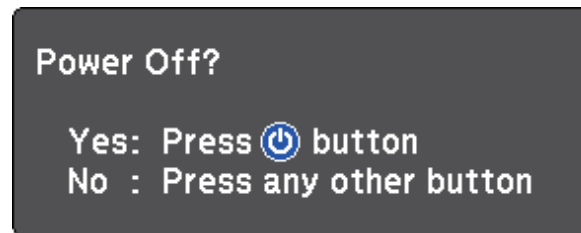

- 2 Press the [⏻] power button again. (To leave it on, press any other button.)
After the beep sounds twice, the projected image disappears and the status indicator turns off.



Since this projector does not require a cool-down time, you can put it away or move it immediately.

- 3 Unplug the power code.

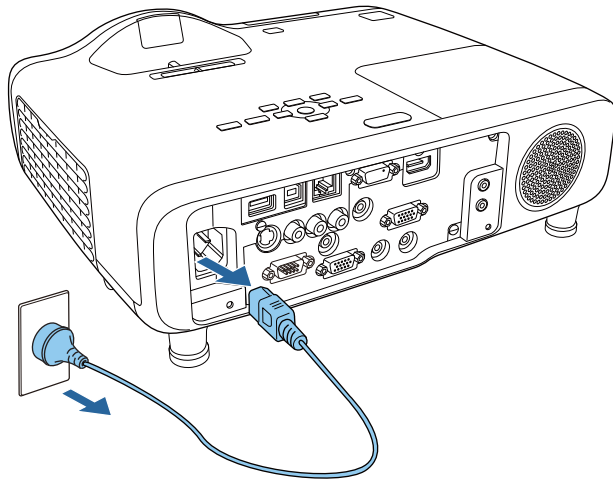

- 4** Attach the lens cover.

Automatically Detect Input Signals and Change the Projected Image (Source Search)

Press the [Source Search] button to project images from the port currently receiving an image.

Using the remote control

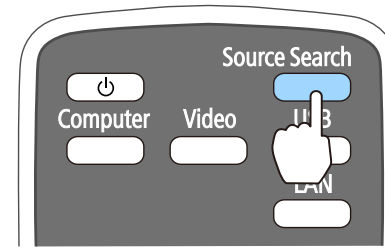

Using the control panel

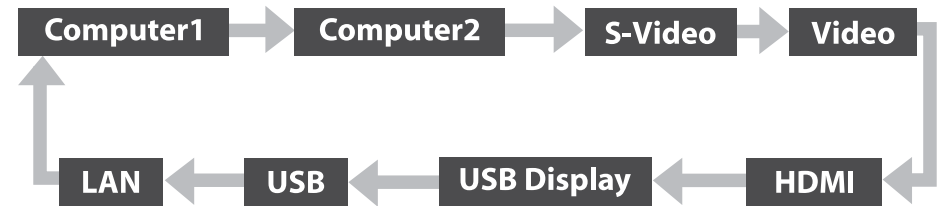
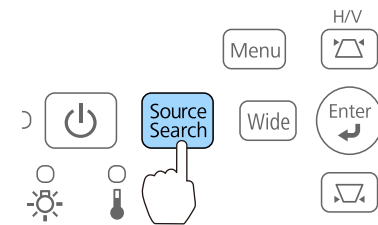

When two or more image sources are connected, press the [Source Search] button until the target image is projected.

When your video equipment is connected, start playback before beginning this operation.



- You can make settings so that images are projected from the same input port the next time the projector is turned on.
 - Extended - Operation - Startup Source Search p.120
- The following screen is displayed while no image signals are input.

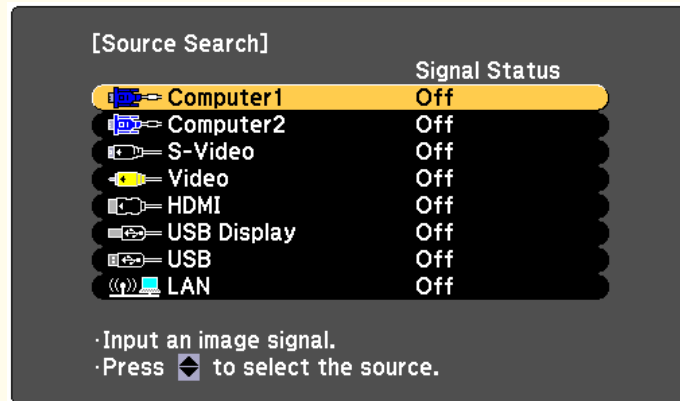

Switching to the Target Image Using the Remote Control

You can change directly to the target image by pressing the following buttons on the remote control.

Remote control

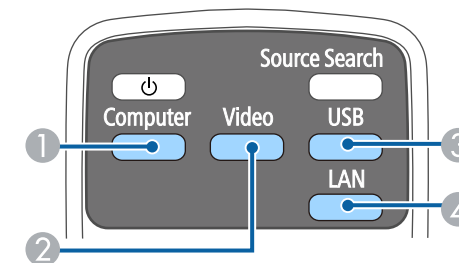

- Each time the button is pressed, it cycles through the images being input from the following sources.
 - Computer1 port
 - Computer2 port
- Each time the button is pressed, it cycles through the images being input from the following sources.
 - S-Video port
 - Video port
 - HDMI port
- Each time the button is pressed, it cycles through the following images:
 - USB Display
 - Images from the device connected to the USB-A port
- Switches to the image from the network connected device.

Projecting with USB Display

You can use the supplied or a commercially available USB cable to connect the projector to a computer to project images from the computer.

You can send the computer's audio with the projected image.

When using EB-536Wi, set **USB Type B** to **USB Display/Easy Interactive Function** or **Wireless Mouse/USB Display** to use USB Display.

☛ **Extended - USB Type B** [p.120](#)

System requirements

For Windows

OS	Windows 2000*1	
	Windows XP	Professional 32 bit Home Edition 32 bit Tablet PC Edition 32 bit
	Windows Vista	Ultimate 32 bit Enterprise 32 bit Business 32 bit Home Premium 32 bit Home Basic 32 bit
	Windows 7	Ultimate 32/64 bit Enterprise 32/64 bit Professional 32/64 bit Home Premium 32/64 bit Home Basic 32 bit Starter 32 bit
	Windows 8	Windows 8 32/64 bit Windows 8 Pro 32/64 bit Windows 8 Enterprise 32/64 bit

	Windows 8.1	Windows 8.1 32/64 bit Windows 8.1 Pro 32/64 bit Windows 8.1 Enterprise 32/64 bit
CPU	Mobile Pentium III 1.2 GHz or faster Recommended: Pentium M 1.6 GHz or faster	
Amount of Memory	256 MB or more Recommended: 512 MB or more	
Hard Disk Space	20 MB or more	
Display	Resolution of no less than 640 x 480 and no higher than 1920 x 1200. Display color in 16-bit color or greater	

*1 Service Pack 4 only

For OS X

OS	Mac OS X 10.5.x 32 bit Mac OS X 10.6.x 32/64 bit OS X 10.7.x 32/64 bit OS X 10.8.x OS X 10.9.x	
CPU	Power PC G4 1GHz or faster Recommended: Core Duo 1.83GHz or faster	
Amount of Memory	512 MB or more	
Hard Disk Space	20 MB or more	
Display	Resolution of no less than 640 x 480 and no higher than 1680 x 1200. Display color in 16-bit color or greater	

Connecting for the First Time

The first time you connect the projector and the computer using the USB cable, the driver needs to be installed. The procedure is different for Windows and OS X.



- You do not need to install the driver the next time you connect.
- When inputting images from multiple sources, change the input source to USB Display.
- If you use a USB hub, the connection may not operate correctly. Connect the USB cable directly to the projector.
- You cannot change option settings while using USB Display.

For Windows

- 1 Connect the computer's USB port to the projector's USB-B port using the supplied or a commercially available USB cable.



For Windows 2000 or Windows XP, a message asking you if you want to restart your computer may be displayed. Select **No**.

For Windows 2000

Double-click **Computer** - EPSON PJ_UD - EMP_UDSE.EXE.

For Windows XP

Driver installation starts automatically.

For Windows Vista/Windows 7/Windows 8/Windows 8.1

When the dialog box is displayed, click run **EMP_UDSE.EXE**.

- 2 When the License Agreement screen is displayed, click **Agree**.

- 3 Computer images are projected.

It may take a while before computer images are projected. Until computer images are projected, leave the equipment as it is and do not disconnect the USB cable or turn off the power to the projector.

- 4 Disconnect the USB cable when you are finished.

When disconnecting the USB cable, there is no need to use **Safely Remove Hardware**.



- If it is not installed automatically, double-click **My Computer** - EPSON PJ_UD - EMP_UDSE.EXE on your computer.
- If nothing is projected, click **All Programs** - EPSON Projector - Epson USB Display - Epson USB Display Ver.x.xx on your computer.
- When using a computer running Windows 2000 under user authority, a Windows error message is displayed and you may not be able to use the software. In this case, try updating Windows to the latest version, restart, and then try to connect again.
For more details, contact your local dealer or the nearest address provided in the following document.
[Epson Projector Contact List](#)

For OS X

- 1 Connect the computer's USB port to the projector's USB-B port using the supplied or a commercially available USB cable. The Setup folder of USB Display is displayed in the Finder.
- 2 Double-click the **USB Display Installer** icon.
- 3 Follow the on-screen instructions to install.

- 4** When the License Agreement screen is displayed, click **Agree**. Enter the administrator authority password and start the installation. When the installation is complete, the USB Display icon is displayed in the Dock and menu bar.
- 5** Computer images are projected. It may take a while before computer images are projected. Until computer images are projected, leave the equipment as it is and do not disconnect the USB cable or turn off the power to the projector.
- 6** When you have finished, select **Disconnect** from the menu bar or from the **USB Display** icon on the Dock. You can then disconnect the USB cable.



- If the USB Display Setup folder is not displayed automatically in the Finder, double-click **EPSON PJ_UD - USB Display Installer** on your computer.
- If nothing is projected for some reason, click the **USB Display** icon in the Dock.
- If there is no **USB Display** icon on the Dock, double-click **USB Display** in the application folder.
- If you select **Exit** from the **USB Display** icon on the Dock, USB Display does not start automatically when you connect the USB cable.

Uninstalling

For Windows 2000

- 1** Click **Start**, select **Settings**, and then click **Control Panel**.
- 2** Double-click **Add/Remove Programs**.
- 3** Click **Change or Remove Programs**.
- 4** Select **Epson USB Display** and click **Change/Remove**.

For Windows XP

- 1** Click **Start**, and then click **Control Panel**.
- 2** Double-click **Add or Remove Programs**.
- 3** Select **Epson USB Display**, and then click **Remove**.

For Windows Vista/Windows 7

- 1** Click **Start**, and then click **Control Panel**.
- 2** Click **Uninstall a program** under **Programs**.
- 3** Select **Epson USB Display**, and then click **Uninstall**.

For Windows 8/Windows 8.1

- 1** Open Charms, and then select **Search**. Right-click (hold down) **Epson USB Display Ver.x.xx**.
- 2** Select **Uninstall** from the app bar.
- 3** Select **Epson USB Display**, and then click **Uninstall**.
- 4** Follow the on-screen instructions to uninstall.

For OS X

- 1** Double-click **Applications - USB Display - Tool**.
- 2** Run **USB Display Uninstaller**.

Correcting Keystone Distortion

You can correct keystone distortion using one of the following methods.

- Correcting manually (H/V-Keystone)
Manually correct distortion in the horizontal and vertical directions independently.

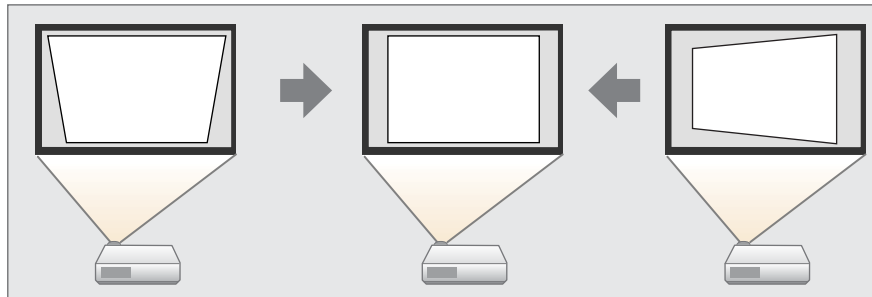

- Correcting manually (Quick Corner)
Manually correct the four corners independently.

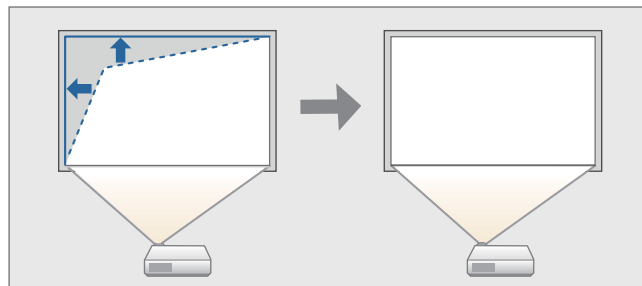

When using EB-536Wi, you can use one of the following methods to correct keystone distortion.

- Correcting automatically (Auto V-Keystone)
Automatically corrects vertical keystone distortion.
- Correcting manually (H-Keystone Adjuster)
Manually corrects horizontal keystone distortion using the horizontal keystone adjuster.

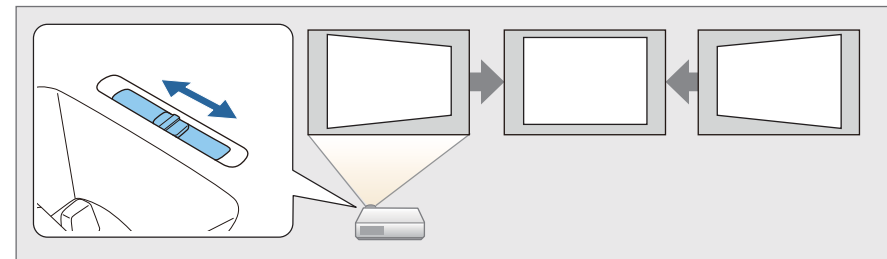

When you correct keystone distortion, the projected image may be reduced.

Correcting Manually

You can manually correct keystone distortion.

You can use H/V-Keystone to correct the projected image under the following conditions.

Correction angle for EB-536Wi: approx. 5° right and left/approx. 7° up and down

Correction angle for EB-535W/EB-525W/EB-530/EB-520: approx. 15° right and left/approx. 15° up and down

H/V-Keystone

Manually correct distortion in the horizontal and vertical directions independently.

- 1 Press the [▽] or [∇] button on the control panel during projection to display the Keystone screen.

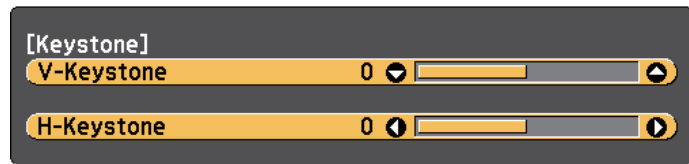

- 2 Press the following buttons to correct keystone distortion. Press the [▽] or [∇] button to correct vertical distortion.

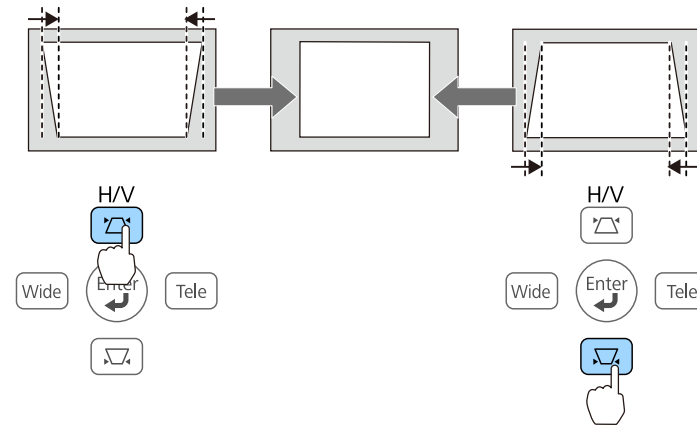

Press the [Wide] or [Tele] buttons to correct horizontal distortion.

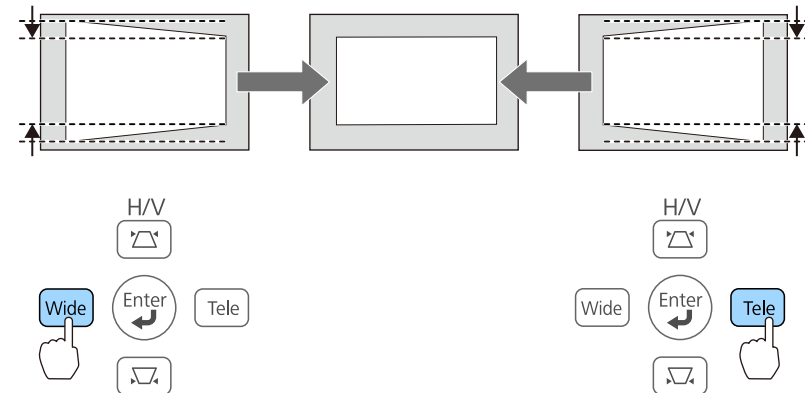

You can also set H/V-Keystone from the Configuration menu.
Settings - Keystone - H/V-Keystone [p.119](#)

Quick Corner

This allows you to manually correct each of the four corners of the projected image separately.

- 1 Press the [Menu] button while projecting.
 ☛ "Using the Configuration Menu" p.113

Using the remote control

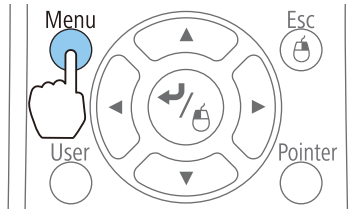

Using the control panel

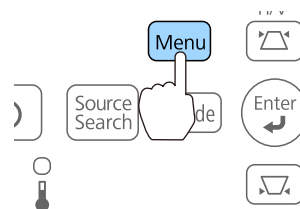

- 2 Select **Keystone** from **Settings**.

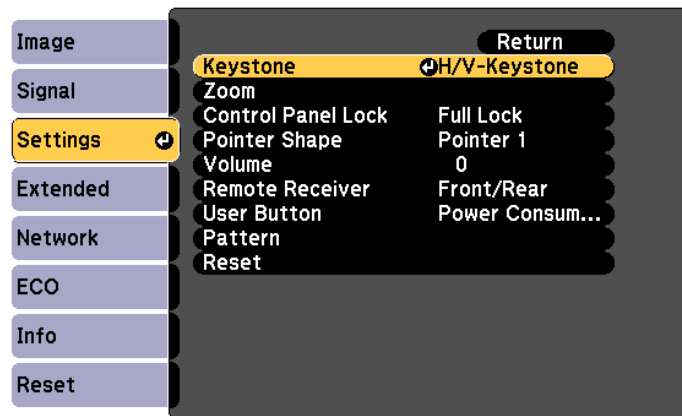

- 3 Select **Quick Corner**, and then press the [↵] button.

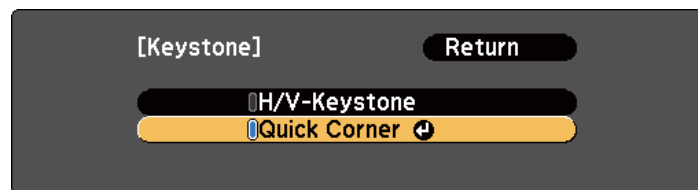

- 4 Select the corner to correct using the [↶], [↷], [↵], and [↶] buttons on the remote control, or the [↶][↷] [Wide], and [Tele], buttons on the control panel, and then press the [↵] button.

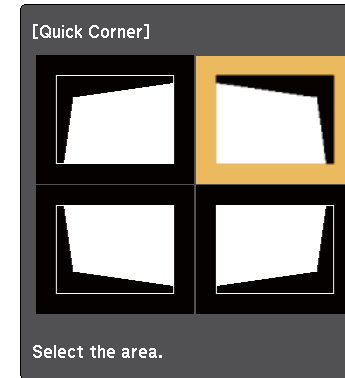

- 5 Correct the position of the corner using the [↶], [↷], [↵], and [↶] buttons on the remote control, or the [↶], [↷], [Wide] and [Tele] buttons on the control panel.

When you press the [↵] button, the screen shown in step 4 is displayed.

If the message "Cannot adjust any further." is displayed while adjusting, you cannot adjust the shape any further in the direction indicated by the gray triangle.



6 Repeat procedures 4 and 5 as needed to adjust any remaining corners.

7 Press the [Esc] button to exit the correction menu.

Because **Keystone** was changed to **Quick Corner**, the corner selection screen shown in step 4 is displayed the next time you press the [↵] or [↶] button on the control panel. Change **Keystone** to **H/V-Keystone** if you want to perform horizontal and vertical correction using the [↵] or [↶] button on the control panel.

☛ [Settings - Keystone - H/V-Keystone p.119](#)



If the [Esc] button is held down for about two seconds while the corner selection screen from step 4 is displayed, the following screen is displayed.

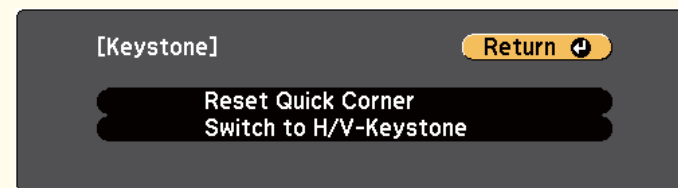

Reset Quick Corner: Resets the result of Quick Corner corrections.

Switch to H/V-Keystone: Switches the correction method to H/V-Keystone.

☛ ["Settings Menu" p.119](#)

H-Keystone Adjuster (EB-536Wi only)

Move the horizontal keystone adjuster to the right or left to perform horizontal keystone correction.

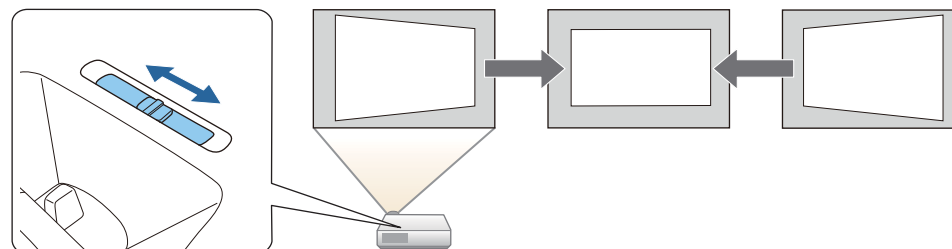

- When using H-Keystone Adjuster, set **H-Keystone Adjuster** to **On**.

☛ [Settings - Keystone - H/V-Keystone - H-Keystone Adjuster p.119](#)

- You can also correct keystone distortion in the horizontal direction using H/V-Keystone.

Correcting Automatically (EB-536Wi only)

Auto V-Keystone

When the projector detects any movement, for example when it is installed, moved, or tilted, it automatically corrects vertical keystone distortion. This function is called Auto V-Keystone.

When the projector remains still for about two seconds after it detects movement, it displays a screen for adjustment and then automatically corrects the projected image.

You can use Auto V-Keystone to correct the projected image under the following conditions.

Correction angle: approx. 7° up and down



- Auto V-Keystone works only when **Projection** is set to **Front** from the Configuration menu.
 ⚙️ **Extended - Projection** [p.120](#)
- If you do not want to enable Auto V-Keystone, set **Auto V-Keystone** to **Off**.
 ⚙️ **Settings - Keystone - H/V-Keystone - Auto V-Keystone** [p.119](#)
- If the projector is moved slightly, motions may not be detected and Auto V-Keystone may not be performed.

Adjusting the Image Size

Press the [Wide] and [Tele] buttons on the control panel to adjust the size of the projected image.

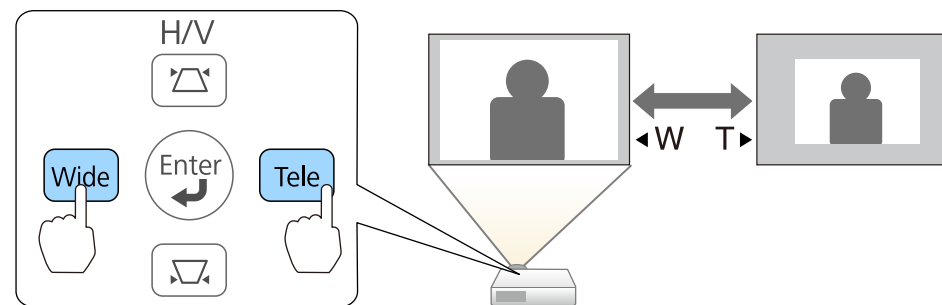

You can also make adjustments from the Configuration menu.

⚙️ **Settings - Zoom** [p.119](#)

Adjusting the Image Position

Press the foot adjust lever to extend the front adjustable foot.

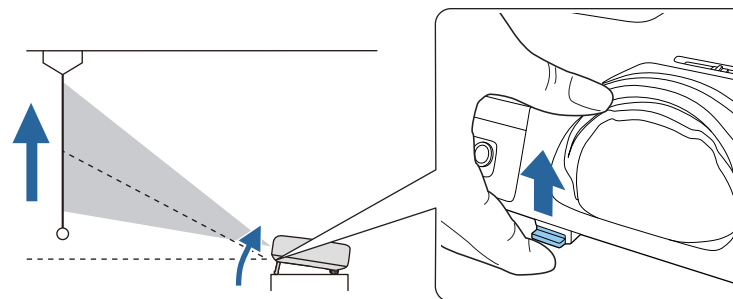

The larger the angle of tilt, the harder it becomes to focus. Install the projector so that it only needs to be tilted at a small angle.

Adjusting the Horizontal Tilt

Extend and retract the rear feet to adjust the projector's horizontal tilt.

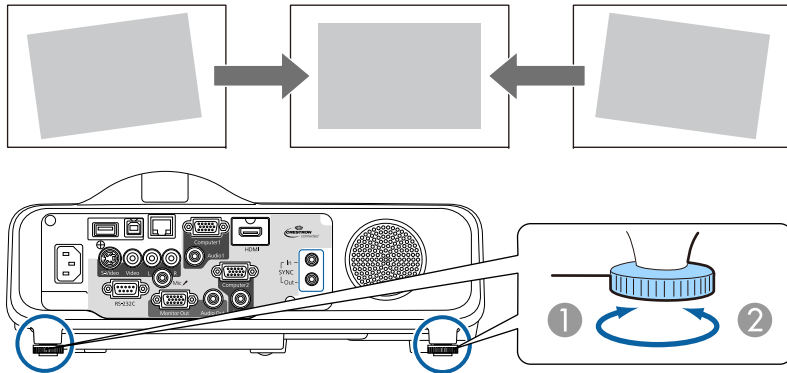

- ① Extend the rear foot.
- ② Retract the rear foot.

Correcting the Focus

You can correct the focus using the focus ring.

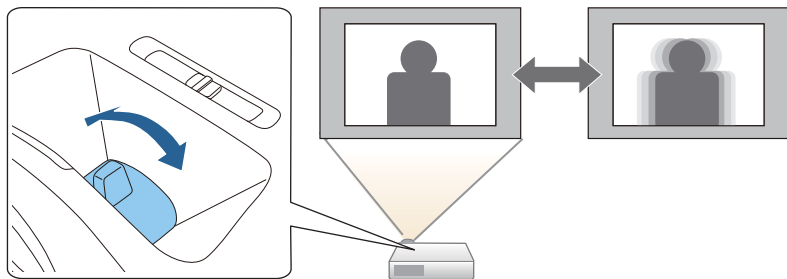

Adjusting the Volume

You can adjust the volume using one of the following methods.

- Press the [Volume] buttons on the remote control to adjust the volume.
 - [] Decreases the volume.
 - [] Increases the volume.

Remote control

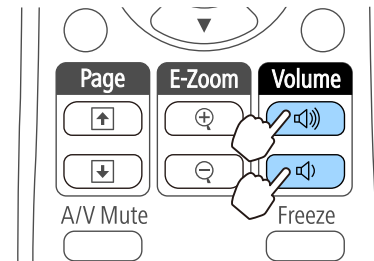

- Adjust the volume from the Configuration menu.
 - ☛ **Settings - Volume** [p.119](#)



Caution

Do not start when the volume is set too high. A sudden increase in volume may cause loss of hearing. Always lower the volume before powering off, so that you can power on and then gradually increase the volume.

Selecting the Projection Quality (Selecting Color Mode)

You can easily obtain the optimum image quality simply by selecting the setting that best corresponds to your surroundings when projecting. The brightness of the image varies depending on the mode selected.

Mode	Application
Dynamic	Ideal for use in a bright room. This is the brightest mode.

Mode	Application
Presentation	Ideal for making presentations using color materials in a bright room. Also ideal for watching TV programs with vivid images in sharp contrast.
Theatre	Ideal for watching films in a dark room. Gives images a natural tone.
sRGB	Ideal for reproducing images that conform to the <u>sRGB</u> color standard. Ideal for projecting still pictures, such as photos.
Blackboard	Even if you are projecting onto a blackboard (greenboard), this setting gives your images a natural tint, just like when projecting onto a screen.

Each time you press the [Color Mode] button, the Color Mode name is displayed on the screen and the Color Mode changes.

Remote control



You can set Color Mode from the Configuration menu.

➡ **Image - Color Mode** p.116

Setting Auto Iris

By automatically setting the luminance according to the brightness of the displayed image, it lets you enjoy deep and rich images.

1 Press the [Menu] button.

➡ "Using the Configuration Menu" p.113

Using the remote control

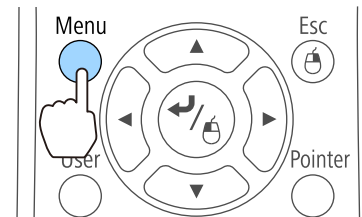

Using the control panel

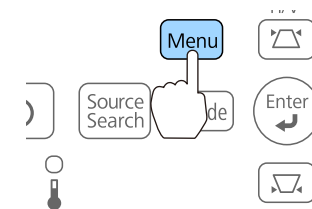

2 Select **Auto Iris** from **Image**.

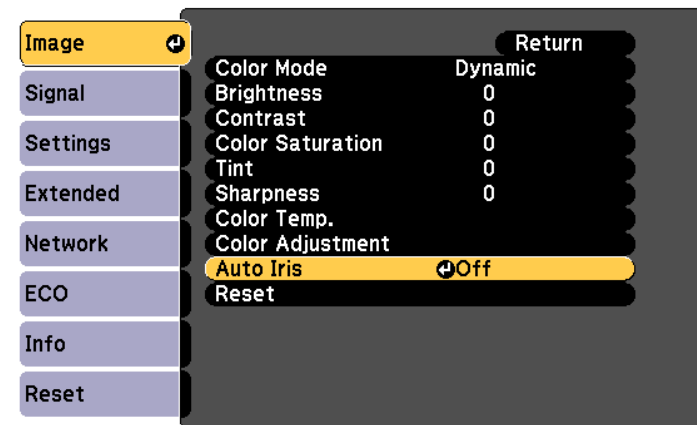

3 Select **Normal** or **High Speed**.

The setting is stored for each Color Mode.

4 Press the [Menu] button to finish making settings.



- **Auto Iris** can only be set when the **Color Mode** is set to **Dynamic** or **Theatre**.
- When **Auto Iris** is set to **Normal** or **High Speed**, **Light Optimizer** is enabled (this is also enabled when **Light Optimizer** is set to **Off** and the settings cannot be changed).

Changing the Aspect Ratio of the Projected Image

You can change the Aspect Ratio of the projected image to suit the type, the ratio of height and width, and the resolution of the input signals.

Available aspect modes vary depending on the image signal currently being projected.

Changing Methods

Each time you press the [Aspect] button on the remote control, the aspect mode name is displayed on the screen and the aspect ratio changes.

Remote control

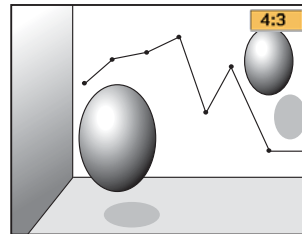
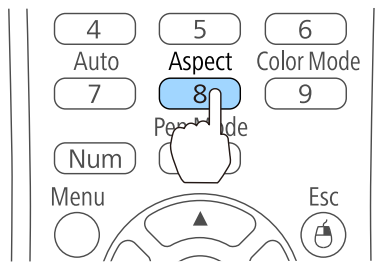

You can set the aspect ratio from the Configuration menu.

☛ **Signal - Aspect** p.117

Changing the Aspect Mode (EB-536Wi/EB-535W/EB-525W only)

Projecting images from video equipment or from the HDMI port

Each time the [Aspect] button on the remote control is pressed, the aspect mode changes in the order **Normal** or **Auto**, **16:9**, **Full**, **Zoom**, and **Native**.

Example: 1080p signal input (resolution: 1920 x 1080, aspect ratio: 16:9)

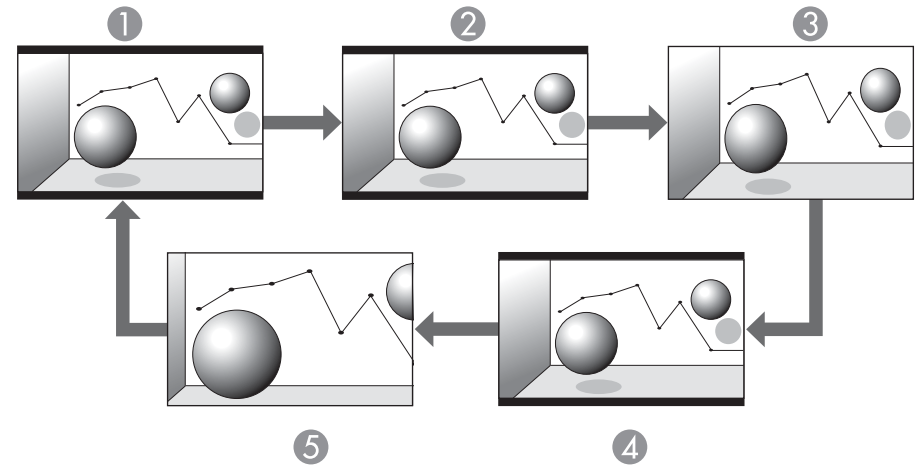

- 1 Normal or Auto
- 2 16:9
- 3 Full
- 4 Zoom
- 5 Native

Projecting Images from a Computer

The following shows projection examples for each aspect mode.

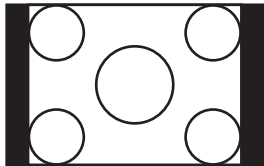
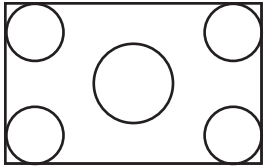
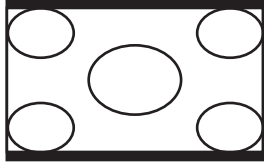
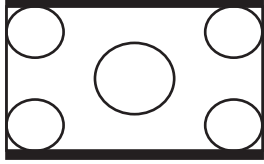
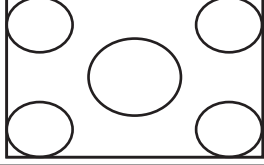
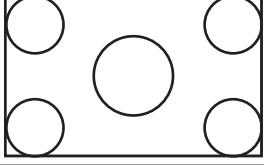
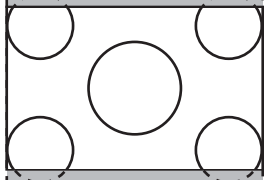
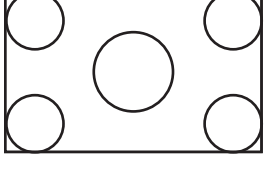
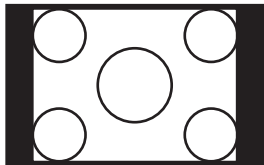
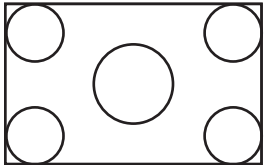
Aspect Mode	Input Signal	
	XGA 1024X768(4:3)	WXGA 1280X800(16:10)
Normal		
16:9		
Full		
Zoom		
Native		



If parts of the image are missing, set the **Resolution** setting to **Wide** or **Normal** from the Configuration menu, according to the size of the computer panel.

☞ **Signal - Resolution** [p.117](#)

Changing the Aspect Mode (EB-530/EB-520 only)

Projecting Images from Video Equipment

Each time the [Aspect] button is pressed, the aspect mode changes in the order **4:3** and **16:9**.

When inputting a 720p/1080i signal and the aspect mode is set to **4:3**, a 4:3 zoom is applied (the right and left sides of the image are cut off).

Example: 720p signal input (resolution: 1280 x 720, aspect ratio: 16:9)

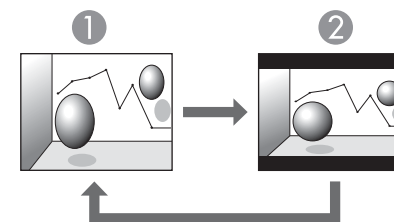

- ① 4:3
- ② 16:9

Projecting Images from the HDMI Port

Each time the [Aspect] button is pressed, the aspect mode changes in the order **Auto**, **4:3**, and **16:9**.

Example: 1080p signal input (resolution: 1920 x 1080, aspect ratio: 16:9)

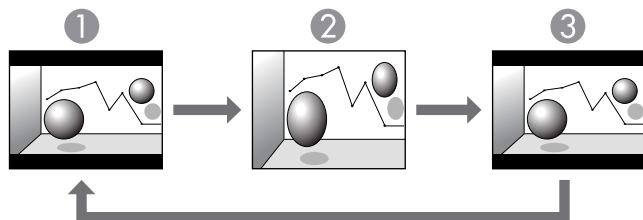

- ① Auto
- ② 4:3
- ③ 16:9

 If parts of the image are missing, set the **Resolution** setting to **Wide** or **Normal** from the Configuration menu, according to the size of the computer panel.

👉 **Signal - Resolution** [p.117](#)

Projecting Images from a Computer

Each time the [Aspect] button is pressed, the aspect mode changes in the order **Normal**, **4:3**, and **16:9**.

The following shows projection examples for each aspect mode.

Aspect Mode	Input Signal	
	XGA 1024X768(4:3)	WXGA 1280X800(16:10)
Normal		
4:3		
16:9		



Using the Interactive Features (EB-536Wi only)

Follow the instructions in these sections to use the interactive features.

The interactive features turn any wall into an interactive whiteboard, either with or without a computer. Three interactive modes are available and it's easy to shift between each mode:

- In annotation mode, you can use interactive pens to add notes to content projected from a computer, tablet, document camera, or other source. This helps you emphasize projected information or include additional notes for more effective lessons or presentations.

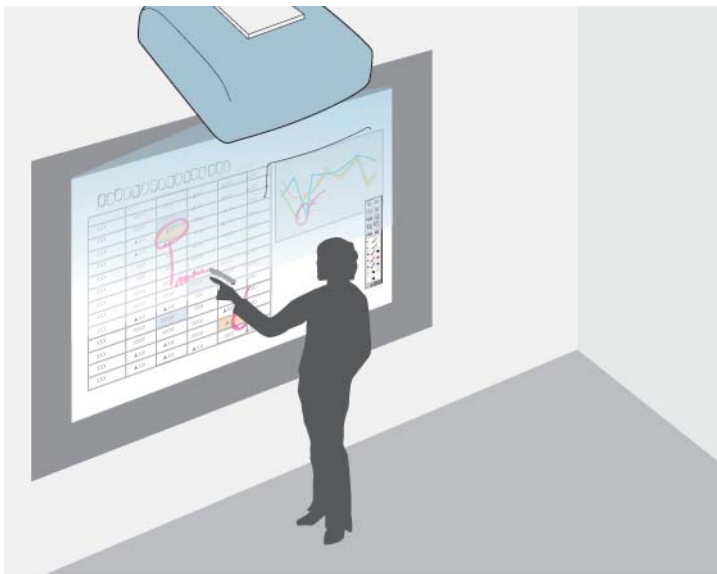

- In whiteboard mode, you can use interactive pens to write on the projected "whiteboard." You do not need to use a computer or install any additional software to use the built-in whiteboard drawing feature.

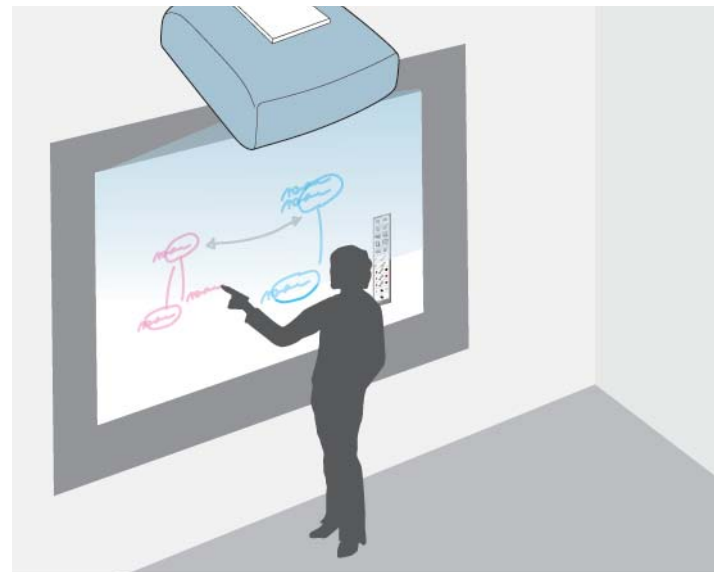

- In computer interactive mode, you can use interactive pens as you would use a mouse. This allows you to navigate, select, and scroll through content projected from your computer.

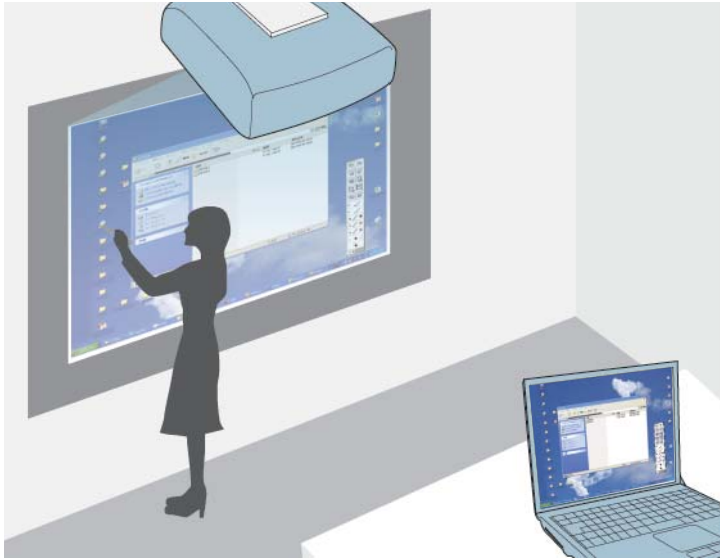

You can also use the Easy Interactive Tools software to provide additional interactive features, such as saving your annotations, and then printing them. See the *Easy Interactive Tools Operation Guide* built into the software for instructions.

Drawing on a Projected Image (Annotation Mode)

Annotation mode lets you project from a computer, tablet, video device, or other source and add notes to your projected content using the interactive pens. You can use both pens at the same time.



- 1** Turn on the projector.

- 2** Make sure you have calibrated the first time you use your projector.

☛ "Pen Calibration" [p.68](#)

- 3** Project an image from a connected device.





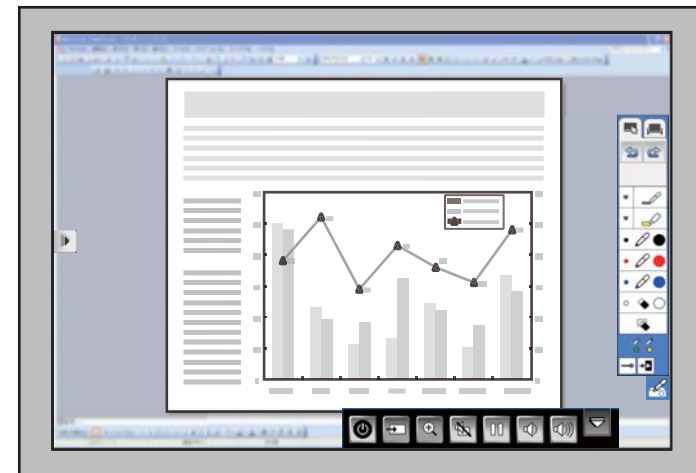

- 4** Hold an interactive pen close to the projected screen.

- 5** To write or draw, tap the  or  toolbar tab.

You see the toolbar on the projected image, for example:





- You can also control the projector from the projected screen by using the projector control toolbar displayed on the screen. Tap the  or  icon if the projector control toolbar is not displayed.
- You can move the  and  toolbar tabs up and down, and the  or  toolbar tab right and left.



You can write on the projected screen.

☛ "Using the Interactive Pens" [p.67](#)

☛ "Interacting with the Screen" [p.74](#)

Using the Projected Screen as a Whiteboard (Whiteboard Mode)

You can use the interactive pens to write or draw on the projection surface just as you would on a chalkboard or dry erase board. You can use both pens at the same time.





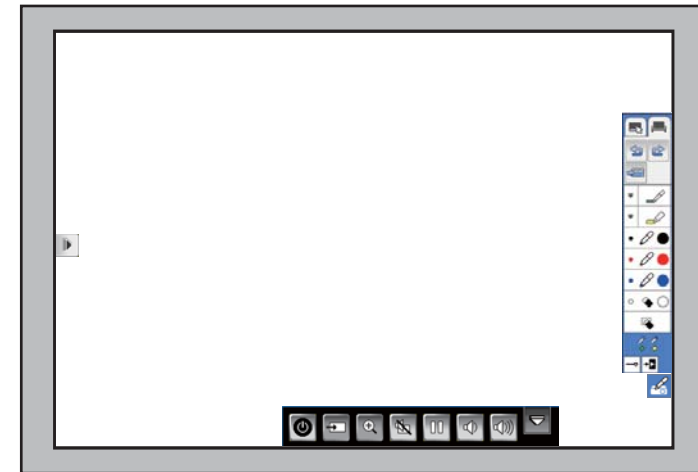

- 1 Turn on the projector.
- 2 Make sure you have calibrated the first time you use your projector.
 - ☛ "Pen Calibration" [p.68](#)
- 3 Hold an interactive pen close to the projected screen.
- 4 Tap the  or  toolbar tab. The toolbar is displayed.

5

Tap the  icon on the toolbar.

You see the whiteboard screen and toolbar, for example:



- You can also control the projector from the projected screen by using the projector control toolbar displayed on the screen. Tap the  or  icon if the projector control toolbar is not displayed.
- You can move the  and  toolbar tabs up and down, and the  or  toolbar tab right and left.

6

To write or draw on the screen, use the toolbar on the right or left side.

☛ "Using the Interactive Pens" [p.67](#)

☛ "Interacting with the Screen" [p.74](#)



You can also use the Easy Interactive Tools software to provide additional interactive features, such as treating the drawing area as a page, and creating multiple pages to draw on. See the *Easy Interactive Tools Operation Guide* for instructions.

Controlling a Computer from the Projected Screen (Computer Interactive Mode)

You can navigate, select, and interact with your computer programs from the projected screen using the interactive pens, just as you would with a mouse.

Computer Interactive Mode System Requirements

Your computer must use one of the following operating systems to use the computer interactive mode.

Windows	Windows XP Service Pack 2 and Service Pack 3 <ul style="list-style-type: none"> • Professional (32 bit) • Home Edition (32 bit) • Tablet PC Edition (32 bit)
	Windows Vista Service Pack 2 <ul style="list-style-type: none"> • Ultimate (32 bit) • Enterprise (32 bit) • Business (32 bit) • Home Premium (32 bit) • Home Basic (32 bit)
	Windows 7 Service Pack 1 <ul style="list-style-type: none"> • Ultimate (32/64 bit) • Enterprise (32/64 bit) • Professional (32/64 bit) • Home Premium (32/64 bit)

	Windows 8 <ul style="list-style-type: none"> • Windows 8 (32/64 bit) • Windows 8 Pro (32/64 bit) • Windows 8 Enterprise (32/64 bit)
	Windows 8.1 <ul style="list-style-type: none"> • Windows 8.1 (32/64 bit) • Windows 8.1 Pro (32/64 bit) • Windows 8.1 Enterprise (32/64 bit)
Mac	OS X <ul style="list-style-type: none"> • Mac OS X 10.5.x • Mac OS X 10.6.x • OS X 10.7.x • OS X 10.8.x • OS X 10.9.x
Ubuntu	Ubuntu <ul style="list-style-type: none"> • 12.04 LTS • 12.10 • 13.04 • 13.10 • 14.04 LTS

Using Computer Interactive Mode

You can control your computer programs with the projected screen using computer interactive mode.

To use computer interactive mode, connect your computer to the projector with the supplied USB cable.

For OS X, you need to install the Easy Interactive Driver to use computer interactive mode.



- When you use multiple displays with Windows 7 and use interactive features on the secondary display, make the following settings:
 - Set the **Pen Operation Mode** setting to **One User/Pen** in the **Easy Interactive Function** setting in the projector's **Extended** menu.
 - Go to **Control Panel > Hardware and Sound > Table PC Settings > Setup** to launch the setup program and configure the interactive features.

If you set up a third display, you cannot use interactive features with that display.

You cannot write or draw across multiple screens.
- To use computer interactive mode over a network, you need to install EasyMP Network Projection version 2.85 or later (for Windows) or 2.83 or later (for OS X), or Quick Wireless version 1.32 or later.

- 1 If you are using OS X, install the Easy Interactive Driver on your computer the first time you use the interactive features.
 - ☛ "Easy Interactive Driver System Requirements (OS X only)" [p.65](#)
 - ☛ "Installing Easy Interactive Driver on OS X" [p.65](#)

- 2 Connect the projector to your computer using a USB cable.



You do not need a USB cable when using computer interactive mode over a network.

☛ "Using the Interactive Features over a Network" [p.80](#)

- 3 Turn on the projector.
- 4 Project your computer's desktop.
- 5 Press the [Menu] button, select the **Extended** menu, and press the [Enter] button.

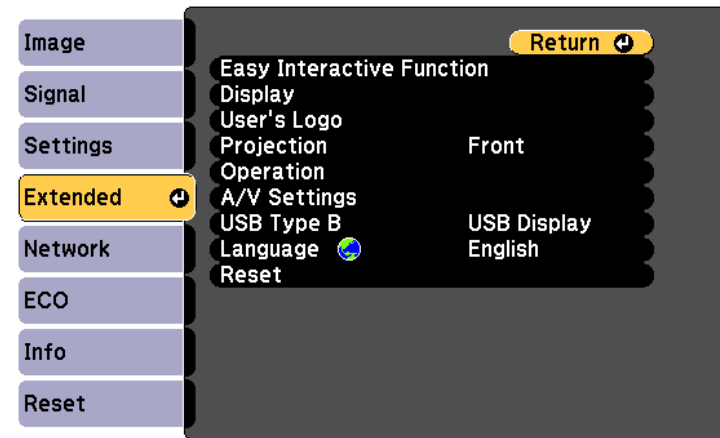

- 6 Select the **USB Type B** setting and press the [Enter] button.

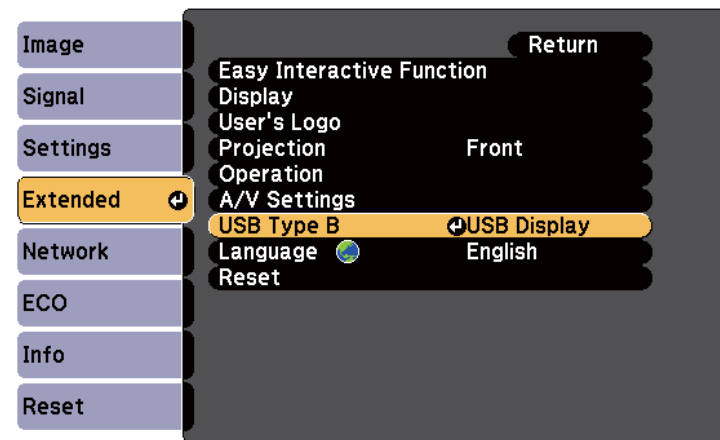

- 7 Select one of the following:
 - When projecting using a computer cable or over a network, select **Easy Interactive Function**.

- To use computer interactive mode and USB Display at the same time, select **USB Display/Easy Interactive Function**.



When projecting using USB Display, response time may be slower.

- 8 Select the **Easy Interactive Function** setting from the **Extended** menu, and then press the [Enter] button.

- 9 Set the **Pen Operation Mode** to **Two Users/Mouse** or **One User/Mouse**.

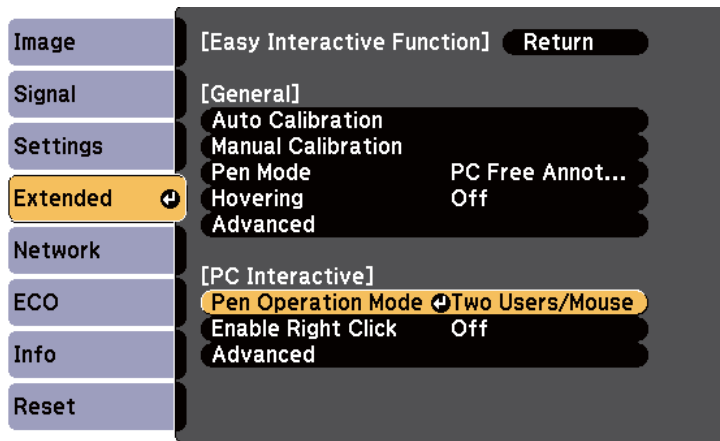

- 10 Press the [Enter] button, and then press the [Menu] button to exit the projector's menu system.

- 11 Make sure you have calibrated the first time you use your projector.

☛ "Pen Calibration" p.68

- 12 Hold an interactive pen close to the projected screen.



The  icon is displayed on the projected screen.



- The  icon is displayed on the right for the first time. Next time, it is displayed on the side from which you last opened the toolbar.

- If the  icon is not displayed, set the **Pen Mode Icon** setting to **On** in the projector's **Extended** menu.

☛ **Extended - Display - Pen Mode Icon** p.120

- 13 Select the  icon, and then select the  icon.

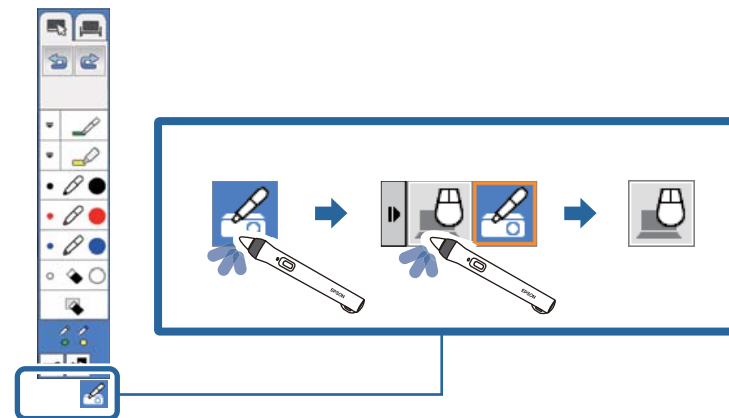









You can also change to computer interactive mode by doing the following:

- Pressing the [Pen Mode] button on the remote control.
- Changing the **Pen Mode** setting on the projector's **Extended** menu to **PC Interactive**.
 - ☛ **Extended - Easy Interactive Function - Pen Mode** [p.123](#)

You can now operate the computer using the interactive pen.

- ☛ "Using the Interactive Pens" [p.67](#)
- ☛ "Interacting with the Screen" [p.74](#)
- ☛ "Using the Interactive Features over a Network" [p.80](#)



- You can also control the projector from the projected screen by using the projector control toolbar displayed on the screen. Tap the  or  icon if the projector control toolbar is not displayed.
- You can move the  and  toolbar tabs up and down, and the  or  toolbar tab right and left.
- You can also do the following in computer interactive mode:
 - Use the Tablet PC input panel in Windows 7 or Windows Vista.
 - Use Ink Tools for annotation in Microsoft Office applications.
- Using two interactive pens at the same time may cause interference in some application software. In that case, move any pen you are not using away from the projection screen.

Easy Interactive Driver System Requirements (OS X only)

To use computer interactive mode, you must install the Easy Interactive Driver on your computer. Check the system requirements necessary to run the software.

Operating Systems	Mac OS X 10.5.x Mac OS X 10.6.x OS X 10.7.x OS X 10.8.x OS X 10.9.x
CPU	Power PC G4 1 GHz or faster (Recommended: CoreDuo 1.83 GHz or faster)
Amount of Memory	512 MB or more
Hard Disk Space	100 MB or more
Display	Resolutions no lower than 1024 x 768 (XGA) and no higher than 1920 x 1200 (WUXGA) 16-bit color or greater (approximately 32,000 display colors)

Installing Easy Interactive Driver on OS X

Install Easy Interactive Driver on your computer to use computer interactive mode.



You may have already installed Easy Interactive Tools using the **Easy Install** option, which also installs Easy Interactive Driver. See the *Easy Interactive Tools Operation Guide* in the Document CD-ROM for details.

- 1** Turn on your computer.

- 2** Insert the EPSON Projector Software for Easy Interactive Function CD into the computer.
You see the EPSON window.
- 3** Double-click the **Install Navi** icon in the EPSON window.
- 4** Select **Custom Install**.
- 5** Follow the on-screen instructions to install.
- 6** Restart your computer.

Your projector comes with a blue pen and an orange pen, identified by the color on the end of the pen. You can use either pen, or both at the same time (one of each color).

Make sure the pen batteries are installed.

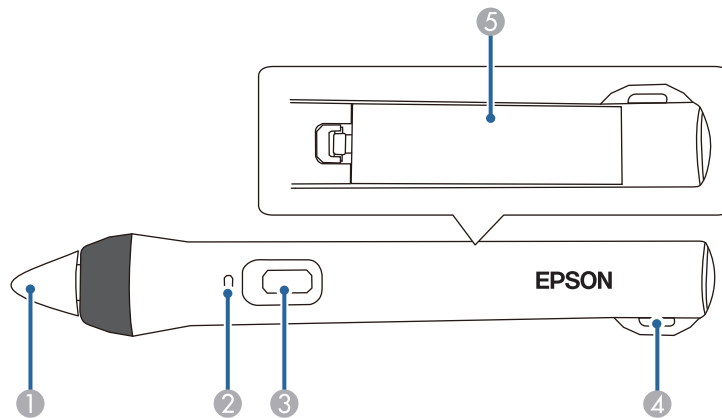

- ① Pen tip
- ② Battery light
- ③ Button
- ④ Attachment for optional strap or cord
- ⑤ Battery cover

To turn on the pen, tap the pen tip or press the button on the side.

When you are finished using the pen, leave the pen as it is far from the projection screen.

🖱️ "Easy Interactive Pen (EB-536Wi only)" [p.19](#)

Attention

- Do not use interactive pens with wet hands or in locations where the pens may get wet. The pen is not waterproof.
- Keep the projector and projection screen out of direct sunlight, or the interactive features may not work.



- The pens turn off automatically after 20 minutes of inactivity. To turn a pen back on, tap the pen tip or press the button on the side.
- For best performance, hold the pen perpendicular to the board, as shown below. Do not cover the black band near the tip of the pen.

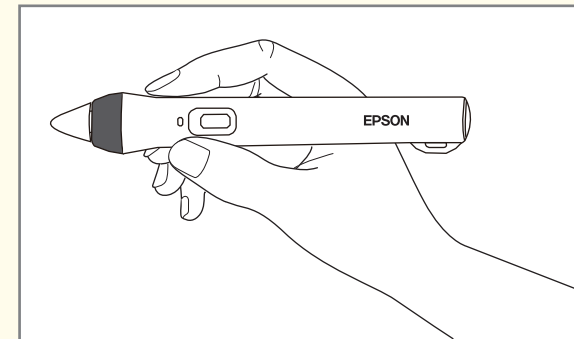

You can do the following using the pen:

- Write or draw on the projection surface in annotation mode and whiteboard mode.

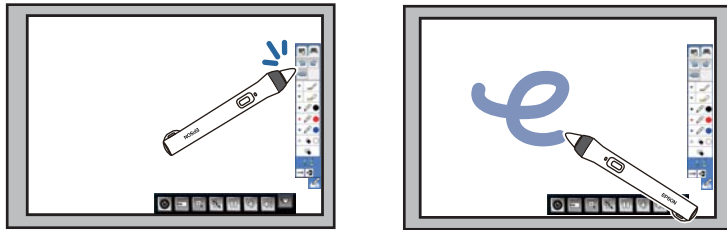

- To select a projected item, such as an icon, tap the projection surface with the pen tip.
- To draw on the projected screen, tap the projection surface with the pen and drag it as necessary.
- To move the projected pointer, hover over the surface without touching it.
- Use the pen as a mouse in computer interactive mode.



- To left-click, tap the board with the pen tip.
- To double-click, tap twice with the pen tip.
- To click and drag, tap and drag with the pen.
- To move the cursor, hover over the board without touching it.



- If you do not want to use the hovering feature, you can turn it off using the **Easy Interactive Function** setting in the projector's **Extended** menu.
 - **Extended - Easy Interactive Function - Hovering p.123**
- To make a long press of the pen act as a right-click, select the following settings in the **Easy Interactive Function** setting in the projector's **Extended** menu.
 - Set the **Pen Operation Mode** to **Two Users/Mouse** or **One User/Mouse**.
 - Set **Enable Right Click** to **On**.

Pen Calibration

Calibration coordinates the positioning of the pen with the location of your cursor. You only need to calibrate the first time you use your projector.

You can use **Auto Calibration** to calibrate the system, but **Manual Calibration** is also available for finer adjustments or if **Auto Calibration** failed.



- Move any pen you are not using away from the projection screen while calibrating the system.
- Calibrate the system again if you notice any discrepancy in positioning after doing any of the following:
 - Performing Keystone correction
 - Adjusting the image size
 - Changing the projector position
- The calibration results remain until you recalibrate.

Calibrating Automatically

You need to calibrate the first time you use your projector, and you do not need the pens or a computer for **Auto Calibration**.

When you hold down the [A/V Mute] button on the top of the projector for approximately three seconds, a pattern is projected and Auto Calibration begins.

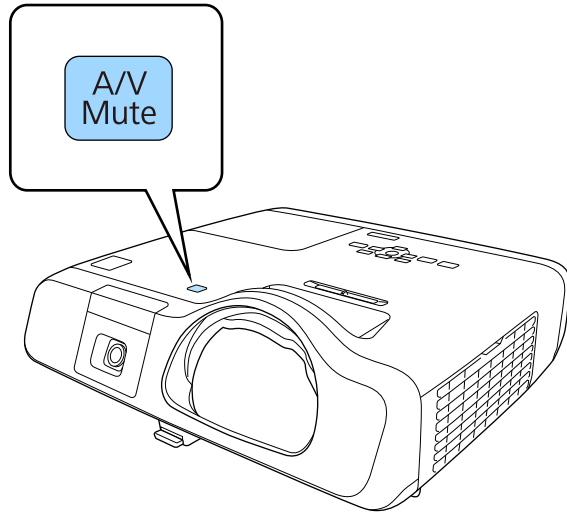

If Auto Calibration fails, an error message is displayed. Perform Manual Calibration.

The cursor location and pen position should match after calibration. If not, you may need to perform Manual Calibration.



- You can perform Auto Calibration from the Configuration menu. Perform operations as instructed in the message displayed.
 - ☛ **Extended - Easy Interactive Function - Auto Calibration** [p.123](#)
- You cannot perform Auto Calibration from the remote control's [A/V Mute] button. When you hold down the remote control's [A/V Mute] button, the **Projection** changes.
 - ☛ **Extended - Projection** [p.120](#)

Calibrating Manually

If the cursor location and pen position do not match after auto calibration, you can calibrate manually.

- 1** Press the [Menu] button, select the **Extended** menu, and press the [Enter] button.

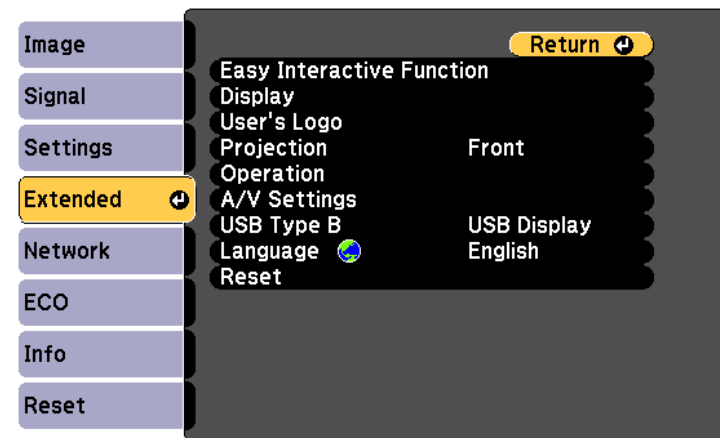

- 2** Select the **Easy Interactive Function** setting and press the [Enter] button.

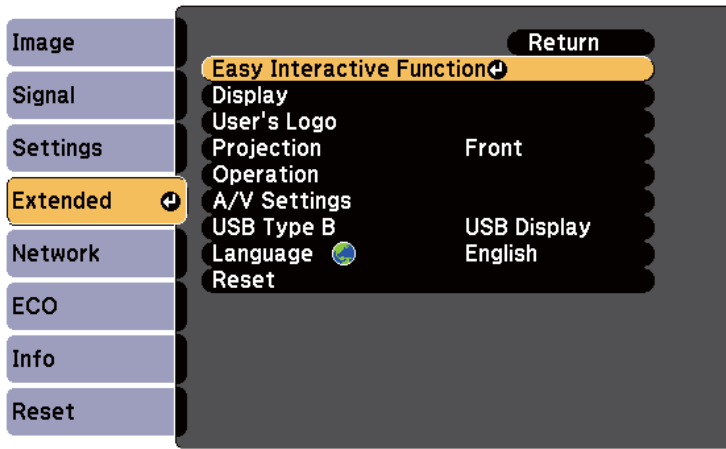

3 Select **Manual Calibration** and press the [Enter] button.

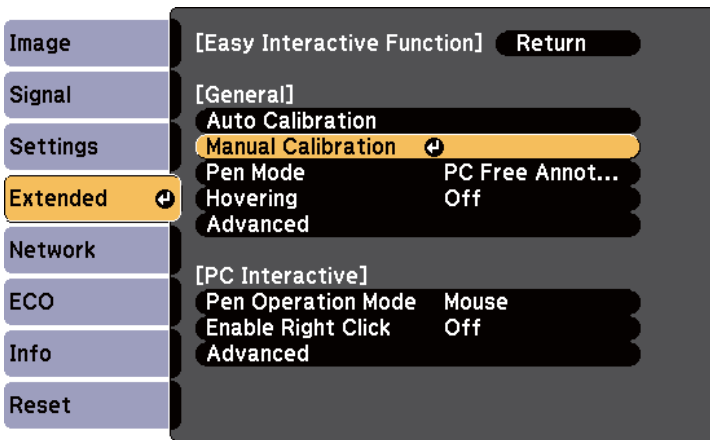

The following screen appears.

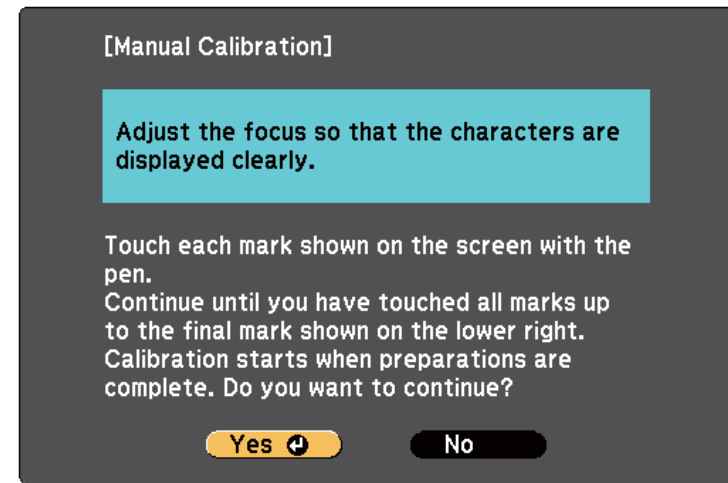

- 4** Adjust the focus if necessary, by sliding the focus lever.
- 5** Select **Yes** and press the [Enter] button.
A flashing green circle appears in the upper left corner of your projected image.
- 6** Touch the center of the circle with the tip of the pen.
The circle disappears, and you see another circle below the first one.

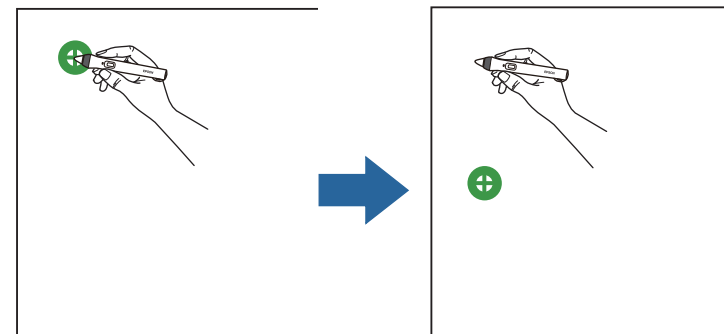



For the most accurate calibration, make sure you touch the center of the circle.

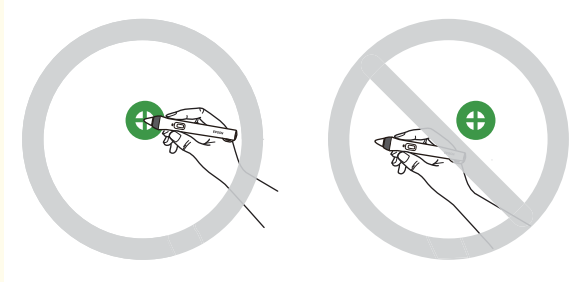

- 7** Touch the center of the next circle, then repeat. When you get to the bottom of the column, the next circle appears at the top of a new column.

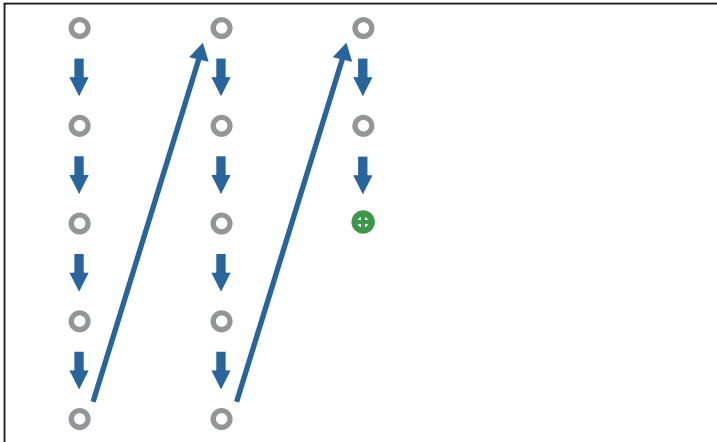

- Make sure you are not blocking the signal between the pen and the interactive receiver.
- If you make a mistake, press the [Esc] button on the remote control to go back to the previous circle.
- To cancel the calibration process, press and hold the [Esc] button for 2 seconds.

- 8** Continue until all of the circles disappear.

Adjusting the Pen Operation Area

The pen operation area is normally adjusted automatically if you connect a different computer or adjust the computer's resolution. If you notice that the pen position is incorrect when you operate your computer from the projected screen (computer interactive mode), you can adjust the pen area manually.



Manual adjustment is not available when projecting from a LAN source.

- 1** Switch to computer interactive mode, if necessary.
 - ☛ "Using Computer Interactive Mode" p.62
- 2** Press the [Menu] button, select the **Extended** menu, and press the [Enter] button.

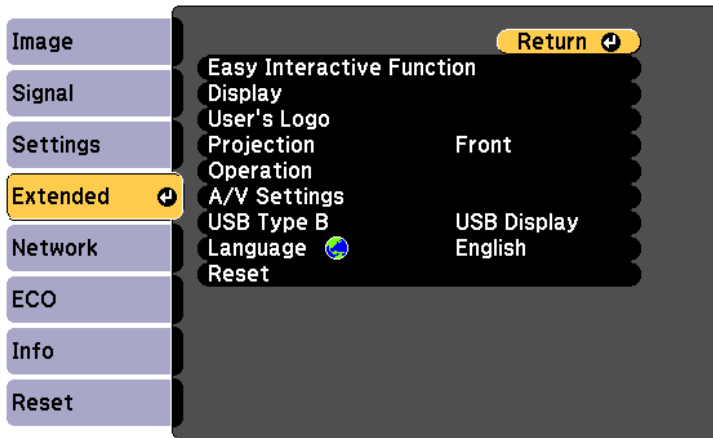

- 3** Select the **Easy Interactive Function** setting and press the [Enter] button.

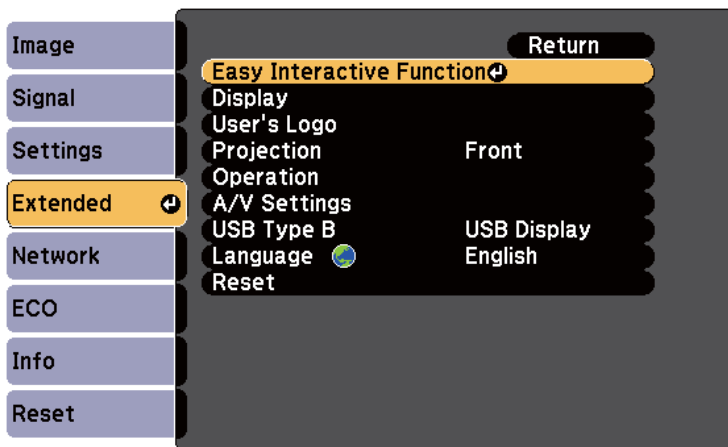

- 4** In the **PC Interactive** section, select **Advanced** and press the [Enter] button.

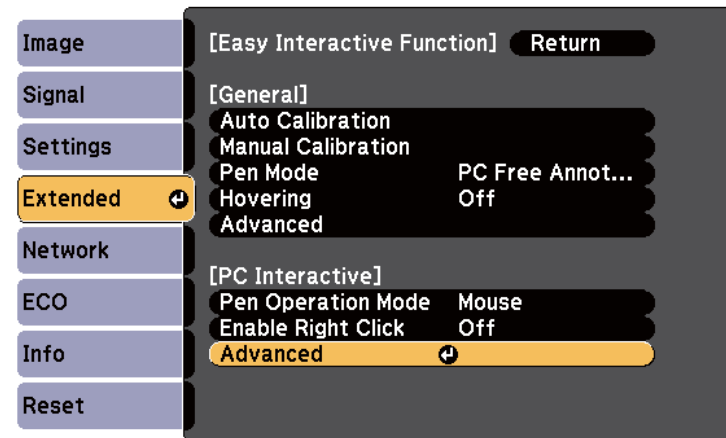

- 5** Select **Manual Adj. Pen Area**, and then press the [Enter] button.

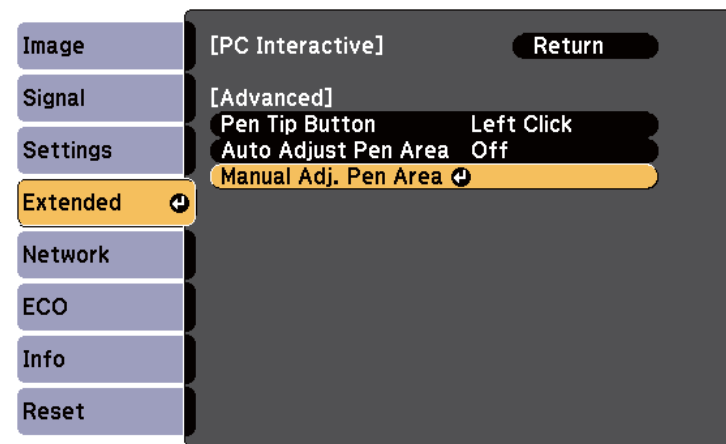

- 6** Select **Yes**, and then press the [Enter] button.

[Manual Adj. Pen Area]

Adjust the pen area to match the position of
the pen to the mouse pointer.
Do you want to continue?

Yes ↻

No

The mouse pointer moves towards the top left.

- 7** When the mouse pointer stops at the top left corner of the image, touch the tip of the pointer with the pen.

The mouse pointer moves towards the bottom right corner.

- 8** When the mouse pointer stops at the bottom right corner of the image, touch the tip of the pointer with the pen.

Follow these instructions to interact with the projected image or control the projector.

Switching the Interactive Mode

You can easily switch the interactive mode using the toolbar.

- To switch between computer interactive mode and annotation mode, select one of the following icons:
 - To change from annotation mode or whiteboard mode to computer interactive mode:

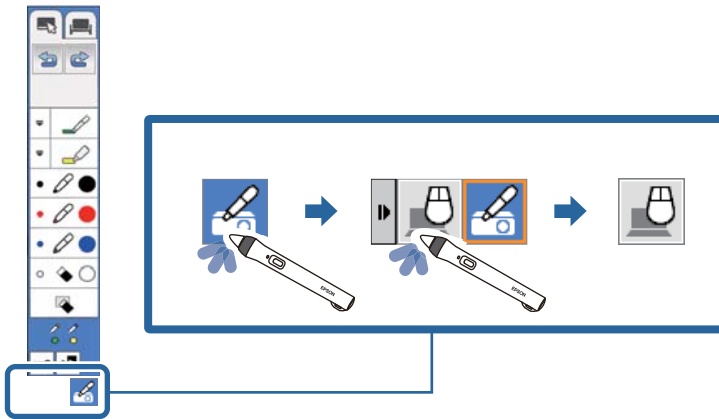

- To change from computer interactive mode to annotation mode or whiteboard mode:

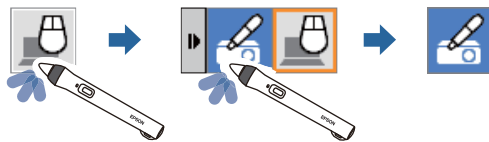

- To switch between annotation mode and whiteboard mode, select the following icon in the toolbar.

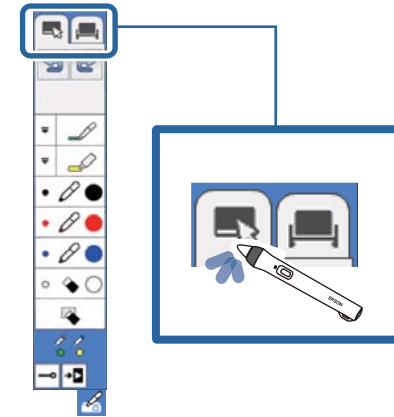





- You can also change the interactive mode by doing the following:
 - Pressing the [Pen Mode] button on the remote control.
 - Switching to **PC Free Annotation** or **PC Interactive** in the **Pen Mode** setting on the projector's **Extended** menu.
 - ☛ **Extended - Easy Interactive Function - Pen Mode p.123**
- You can switch to computer interactive mode when you project the computer screen.
- You cannot switch to computer interactive mode when the **USB Type B** setting in the projector's **Extended** menu is set to **Wireless Mouse/USB Display**.
- The computer screen is projected when you switch to computer interactive mode from whiteboard mode.
- After changing to computer interactive mode, content drawn using annotation mode is retained.



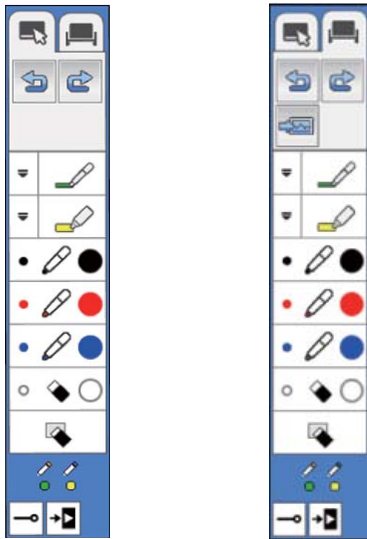







Annotation Mode and Whiteboard Mode Toolbars

The annotation mode toolbar or the whiteboard mode toolbar lets you draw and write on the projected screen. The toolbar also lets you easily switch to annotation or whiteboard mode.

In the following illustration, the annotation mode toolbar is shown on the left, and the whiteboard mode toolbar on the right:



	Switches to annotation mode.
	Switches to whiteboard mode.
	Undoes the last operation.

	Redoes the last undo.
	Selects a white or black background or one of four patterns (whiteboard mode only). ☛ "Selecting Whiteboard Templates" p.77
	Writes or draws free-form lines with custom pen. Select the  icon to change custom pen color and width. ☛ "Selecting Line Width and Color" p.76
	Writes or draws free-form lines with a transparent highlighter pen. Select the  icon to change highlighter pen color and width. ☛ "Selecting Line Width and Color" p.76
	Changes to a black pen. Click on the right of the icon to draw thick lines, and click on the left of the icon to draw fine lines.
	Changes to a red pen. Click on the right of the icon to draw thick lines, and click on the left of the icon to draw fine lines.
	Changes to a blue pen. Click on the right of the icon to draw thick lines, and click on the left of the icon to draw fine lines.
	Switches to an eraser. Click on the right of the icon to erase wider areas, and click on the left of the icon to erase narrower areas.
	Clears all drawings.

	Displays which tool you are using with your pen . : Using pen tools. The color of the icon indicates the color of the pen. : Using eraser tools.
	Hides or shows the toolbar while drawing. : The toolbar is hidden while drawing. : The toolbar is always displayed.
	Closes the toolbar.

Selecting Line Width and Color

You can select the color and line width for both the custom Pen and the Highlighter tools.

- 1 Select the icon next to the custom Pen or Highlighter annotation tool.

A box like the following appears.



- 2 Select the line width and color you want to use for the Pen or Highlighter tools.



- As you hover over the color palette, the name of the color is displayed at the bottom of the palette.
- You can change the shade of the color palette using the **Color Palette** setting in the projector's **Extended** menu.
Extended - Easy Interactive Function - General - Advanced - Color Palette [p.123](#)

- 3 Select the or tool, and then use the pen to write or draw on the projection surface.



When multiple people draw on the projected screen using the multiple pens, you can select different colors and line widths for each pen.

Selecting Whiteboard Templates

In whiteboard mode, you can change the background color, and insert horizontal lines or a background template.

- 1 In whiteboard mode, select the  icon.

A box like the following appears:

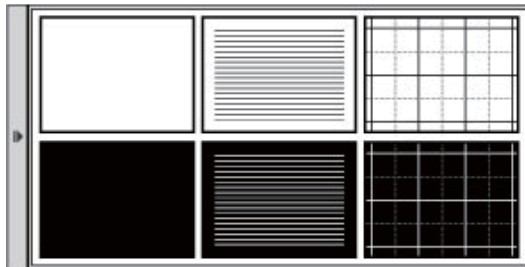











- 2 Select one of the template patterns.

Projector Control Toolbar

The projector control toolbar lets you control the projector from the projected screen just as you would using the remote control.

If your network device is connected to the projector using EasyMP Multi PC Projection, you can also use the toolbar to select the network device from which you want to project.



	Turns off the projector.
	Changes the image source using the displayed list. To close the image source list, select the  icon at the bottom of the list.
	Zooms into and out of the image using the scale or the + and - icons in the displayed list. You can do the following: <ul style="list-style-type: none"> • The image can be enlarged between 1 to 4 times. To return to the original image size, select x1. • You can expand and reduce quickly by holding down the + or - icon. To close the scale list, select the  icon at the bottom of the list.
	Turns off picture and sound. Tap the projected screen to turn the video and audio on. ☛ "Hiding the Image and Sound Temporarily (A/V Mute)" p.90
	Pauses video action. ☛ "Freezing the Image (Freeze)" p.91
	Decreases the volume. ☛ "Adjusting the Volume" p.53
	Increases the volume. ☛ "Adjusting the Volume" p.53
	Closes the projector control toolbar.

Selecting Network Device Display from the Projector Control Toolbar

If you have connected devices to the projector via a network, you can select to project an image from those devices using the projector control toolbar. You can select the image source from computers that are running EasyMP Multi PC Projection, and smartphones or tablets that are running Epson iProjection. You can change the projected screen by selecting from among up to 50 devices.



You can select any connected network device for projection, even if the user connected using the EasyMP Multi PC Projection software with the moderator feature enabled. See the *EasyMP Multi PC Projection Operation Guide* for details about the moderator feature.

[EasyMP Multi PC Projection Operation Guide](#)

- 1 Select the  icon on the projector control toolbar, and then select **Participant List** from the image source list.

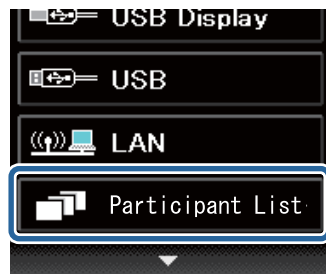

- 2 Select the user name for the device you want to project from.



- 1 Displays the user names for network devices connected to the projector. The  icon is shown next to the user name of the currently projected device.
- 2 Closes the user selection screen and returns to the previous screen.
- 3 Refreshes the user list. When an additional user connects to the projector via a network, select this button to update the user list.



- When a selected device is disconnected from the projector, the selected user's screen is not displayed, and the user's list is automatically updated.
- While the user selection screen is displayed, you cannot do the following:
 - Select a different image source
 - Use other interactive features
 - Control the projector from the projector control toolbar
 - Connect to multiple projectors
 - Hear sound from the projector (it is turned off temporarily)
 - Change the settings using the projector's Configuration menu
 - Project an image using EasyMP Multi PC Projection or Epson iProjection

You see the selected user's screen image.

When you change the user, repeat these steps.



- You cannot access the user selection screen when connecting to multiple projectors by using EasyMP Multi PC Projection and projecting the same image (mirroring).
- If the interactive features do not work, you can return to the previous screen by pressing the [Esc] button on the remote control or the control panel.

You can use your projector in computer interactive mode over a network.

If you want to annotate when using computer interactive mode over a network, you need to use Easy Interactive Tools (or another annotation program). Easy Interactive Tools allows you to use various drawing tools, treat the drawing area as a page, and save your drawings as a file for a later use. You can install Easy Interactive Tools from the EPSON Projector Software for Easy Interactive Function CD. You can also download the software from the Epson website.

- Use one of the following software applications to setup your projector on a computer network and use computer interactive mode over the network:
 - EasyMP Network Projection version 2.85 or later (for Windows) or 2.83 or later (for OS X)
See the *EasyMP Network Projection Operation Guide* for instructions.
 [EasyMP Network Projection Operation Guide](#)
 - Quick Wireless version 1.32 or later (Windows only)
See the instructions included with the optional Quick Wireless Connection USB Key.
- With either application, select **Use Interactive Pen** on the **General settings** tab and **Transfer layered window** on the **Adjust performance** tab.



- You can only use one pen at a time.
- The response may be slower over the network.
- When using computer interactive mode over a network, you cannot change the **Pen Mode** setting using the remote control or from the projector's **Extended** menu. The  icon is also not available.
- You cannot change the **Pen Operation Mode** setting from the projector's **Extended** menu.
- You can connect up to four projectors at one time using EasyMP Network Projection. When connected to multiple projectors, computer interactive mode functions for any projector. Operations performed on one projector are reflected in other projectors.
- To use annotation mode over the network, clear **Use Interactive Pen** on the **General settings** tab and **Transfer layered window** on the **Adjust performance** tab in EasyMP Network Projection or Quick Wireless Connection, and then reconnect to the network.

Precautions When Connecting to a Projector on a Different Subnet

Follow these precautions when you connect to a projector on a different subnet using EasyMP Network Projection and use interactive features:

- Search for the projector on the network by specifying the projector's IP address. You cannot search for it by specifying the projector name.
- Make sure that you get an echo reply back from the network projector when sending an echo request by the ping command. When the Internet Control Message Protocol (ICMP) option is disabled on the router, you can connect to the projector at remote locations even if you cannot get the echo reply back.

- Make sure the following ports are opened.

Port	Protocol	Usage	Communication
3620	TCP/UDP	For connection and control	Duplex
3621	TCP	For transferring images	Duplex
3629	TCP	For controlling projector	Duplex

- Make sure that the MAC address filtering and application filtering options are disabled on the router.
- Make sure that Network Address Translation (NAT) technology is not used in your network environment. With Internet VPN and IP-VPN, you can connect to the network projector remotely when you meet the above requirements.
- When bandwidth management is applied for communications between locations, and EasyMP Network Projection goes over the controlled bandwidth, you may not be able to connect to the projector at remote locations.



Epson does not guarantee the connection to the projector on a different subnet using EasyMP Network Projection even if you meet the above requirements. When considering the implementation, be sure to test the connection in your network environment.

If you are using Windows 8.1, Windows 8, Windows 7, or Windows Vista, you can use the pen input and Ink tools to add handwritten input and annotations to your work.

You can also use the pen input and Ink features over a network when you set the interactive features to be available on your network.

Enabling Windows Pen Input and Ink Features

If you want to use the pen input and Ink features in Windows 8.1, Windows 8, Windows 7, or Windows Vista, you need to adjust the pen settings in the projector's **Extended** menu.

- 1 Press the [Menu] button, select the **Extended** menu, and press the [Enter] button.

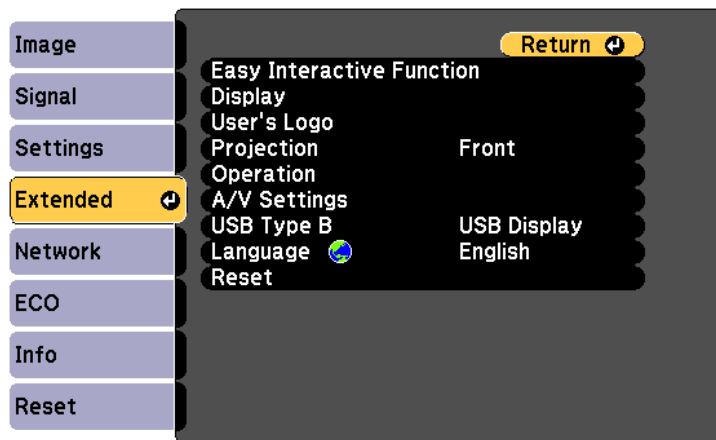

- 2 Select the **Easy Interactive Function** setting and press the [Enter] button.

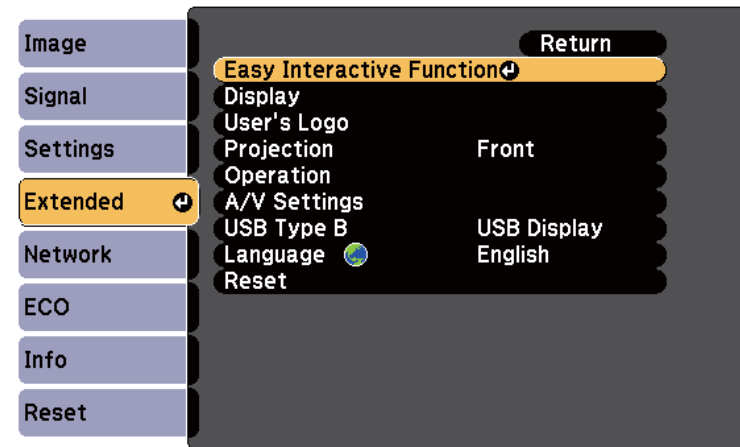

- 3 Select the **Pen Operation Mode** setting and press the [Enter] button.

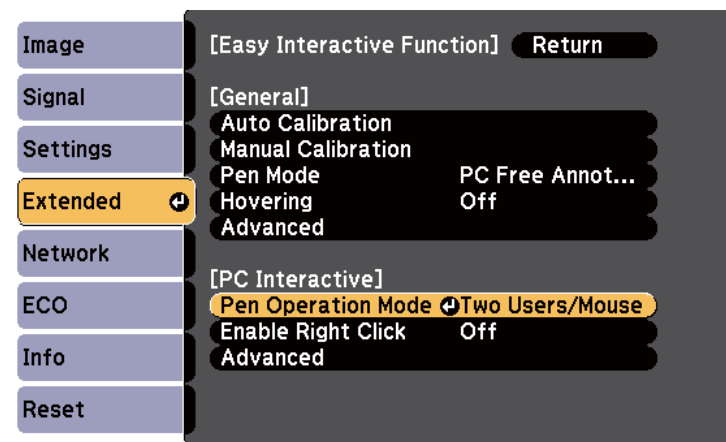

- 4 Select **One User/Pen** and press the [Enter] button.

Using Windows Pen Input and Ink Features

If you are using Windows 8.1, Windows 8, Windows 7, or Windows Vista, you can add handwritten input and convert it to text.

If you have Microsoft Office 2007 or later, you can also use the Ink function to add handwritten notes to a Word document, Excel spreadsheet, or PowerPoint presentation.



Option names for the annotation functions may vary depending on your version of Microsoft Office.

- To open the Touch Keyboard in Windows 8, right-click or tap and hold on the Taskbar, then select **Toolbars > Touch Keyboard**. Select the keyboard icon on the screen, then select the pen icon.
- To open the Tablet PC input panel in Windows 7 or Windows Vista, select  > **All Programs > Accessories > Tablet PC > Tablet PC Input Panel**.
You can write in the box using the pen, then select from a variety of options to edit and convert the text.
- To add Ink annotations in Microsoft Office applications, select the **Review** menu, then select **Start Inking**.



In Microsoft Word or Excel, select the **Insert** tab and then click on **Start Inking**.

- To annotate your PowerPoint slides in Slideshow mode, press the button on the side of the pen, and then select **Pointer Options > Pen** from the pop-up menu.



This method for annotating PowerPoint slides in Slideshow mode also works with Windows XP Tablet PC Edition.

For more information about these features, see your Windows Help.



Useful Functions

This chapter explains useful tips for giving presentations, and the Security functions.

Projecting Images Stored on a USB Storage Device (PC Free)

By connecting a USB storage device such as a USB memory or a USB hard disk to the projector, you can project the files stored on the device without using a computer. This function is called PC Free.



- You may not be able to use USB storage devices that incorporate security functions.
- You cannot correct keystone distortion while projecting in PC Free, even if you press the [↶] and [↷] buttons on the control panel.

Specifications for Files that Can Be Projected Using PC Free

Type	File Type (Extension)	Notes
Image	.jpg	The following cannot be projected. - CMYK color mode format - Progressive format - Images with a resolution greater than 8192 x 8192 Due to the characteristics of JPEG files, images may not be projected clearly if the compression ratio is too high.
	.bmp	Cannot project images with a resolution greater than 1280 x 800.
	.gif	<ul style="list-style-type: none"> • Cannot project images with a resolution greater than 1280 x 800. • Cannot project animated GIFs.
	.png	Cannot project images with a resolution greater than 1280 x 800.

Type	File Type (Extension)	Notes
	.avi (Motion JPEG)	<ul style="list-style-type: none"> • Cannot project images with a resolution greater than 1280 x 720. • You can only playback the audio formatted with linear PCM and ADPCM. • Supports AVI 1.0. You cannot project files over 2 GB.



- When connecting and using a USB-compatible hard disk, make sure you connect the AC adaptor supplied with the hard disk.
- The projector does not support some file systems, so use media that has been formatted in Windows.
- Format the media in FAT16/32.

PC Free Examples

Projecting Images Stored on USB Storage



☛ "Projecting the Selected Images or Movies" [p.87](#)

☛ "Projecting Image Files in a Folder in Sequence (Slideshow)" [p.88](#)

PC Free Operating Methods





Although the following steps are explained based on the remote control, you can perform the same operations from the control panel.

Starting PC Free

- 1** Change the source to USB.
 - ☛ "Switching to the Target Image Using the Remote Control" p.44
- 2** Connect the USB storage device to the projector.
 - ☛ "Connecting USB Devices" p.30

PC Free starts and the file list screen is displayed.

 - The following files are displayed as thumbnails (file contents are displayed as small images).
 - JPEG files
 - AVI files (displays the image at the start of the movie)
 - Other files or folders are displayed as icons as shown in the following table.

Icon	File	Icon	File
	JPEG files*		BMP files
	GIF files		PNG files
	AVI (Motion JPEG) files*		

* When it cannot be displayed as a thumbnail, it is displayed as an icon.



- You can also insert a memory card into a USB card reader and then connect the reader to the projector. However, some commercially available USB card readers may not be compatible with the projector.
- The projector can recognize up to five media at a time.
- If the following screen (Select Drive screen) is displayed, use the [◀], [▼], [▶], and [▲] buttons to select the drive you want to use, and then press the [Enter] button.

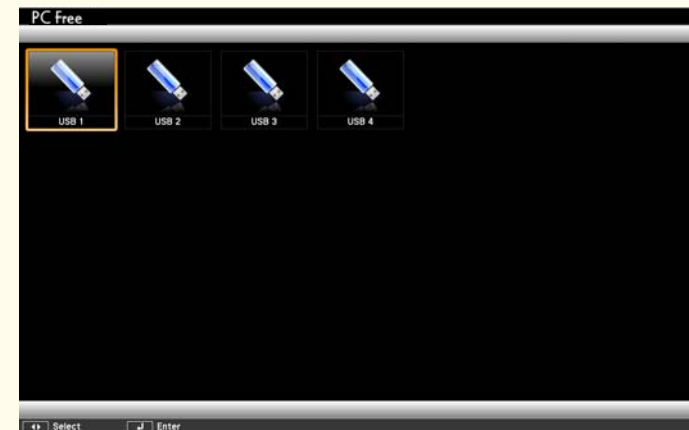

- To display the Select Drive screen, position the cursor on **Select Drive** at the top of the file list screen, and then press the [Enter] button.

Projecting Images

- 1** Use the [◀], [▼], [▶], and [▲] buttons to select the file or folder you want to project.



If not all of the files and folders are displayed on the current screen, press the [↓] button on the remote control, or position the cursor on **Next Page** at the bottom of the screen and press the [Enter] button.

To return to the previous screen, press the [↑] button on the remote control, or position the cursor on **Previous Page** at the top of the screen and press the [Enter] button.

2 Press the [Enter] button.

The selected image is displayed.

When a folder is selected, the files in the selected folder are displayed. To return to the screen which was displayed before opening the folder, position the cursor on **Back to Top** and press the [Enter] button.

Rotating Images

You can rotate the played images in 90° increments. The rotating function is also available during PC Free.

1 Play images, or run PC Free.

2 While projecting, press the [▲] or [▼] button.

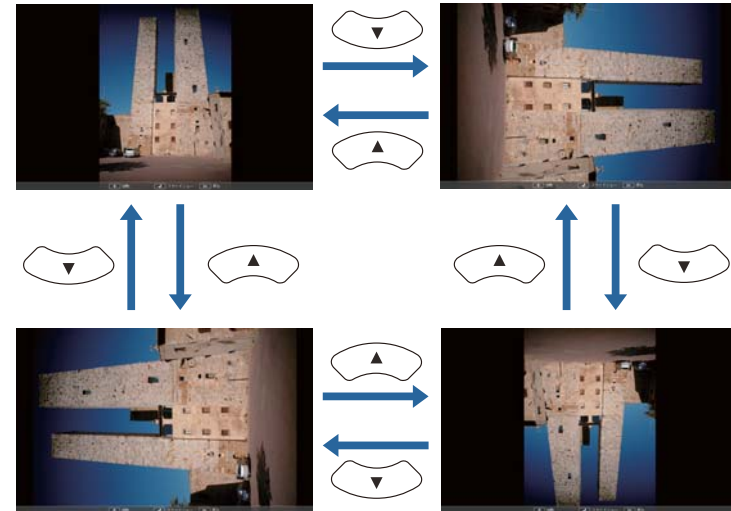

Stopping PC Free

To close PC Free, disconnect the USB device from the USB port on the projector. For devices such as digital cameras or hard disks, turn off the device and then remove it from the projector.

Projecting the Selected Images or Movies





Attention

Do not disconnect the USB storage device while it is being accessed. PC Free may not operate correctly.

1 Start PC Free.

The file list screen is displayed.



☛ "Starting PC Free" p.86

- 2** Press the , , , and  buttons to select the image file you want to project.



- 3** Press the [Enter] button.
The image is displayed.



Press the  or  buttons to move to the next or previous image file.

- 4** To finish projecting, perform one of the following operations.
- Projecting an image: Press the [Esc] button.
 - Projecting a movie: Press the [Esc] button to display the message screen, select **Exit**, and then press the [Enter] button.

When projection is finished, you are returned to the file list screen.





Projecting Image Files in a Folder in Sequence (Slideshow)

You can project the image files in a folder in sequence, one at a time. This function is called Slideshow. Use the following procedure to run Slideshow.



To change files automatically when you run PC Free, set **Screen Switching Time** from **Option** to anything other than **No**. The default setting is 3 seconds.

☛ "Image File Display Settings and Slideshow Operation Settings"
p.89



- 1** Start PC Free.
The file list screen is displayed.
☛ "Starting PC Free" p.86
- 2** Use the , , , and  buttons to position the cursor on the folder you want to run the Slideshow, and then press the [Enter] button.
- 3** Select **Slideshow** at the bottom of the file list screen, and then press the [Enter] button.
Slideshow starts, and the image files in the folder are automatically projected in sequence, one at a time.
When the last file is projected, the file list is displayed again automatically. If you set **Continuous Play** to **On** in the Option

screen, projection starts again from the beginning when it reaches the end.

☛ "Image File Display Settings and Slideshow Operation Settings" [p.89](#)

You can proceed to the next screen, return to the previous screen, or stop playback while projecting a Slideshow.



If **Screen Switching Time** on the Option screen is set to **No**, files do not change automatically when you select Play Slideshow. Press the  button, the [Enter] button, or the  button to continue to the next file.

You can use the following functions when projecting an image file with PC Free.

- Freeze
 - ☛ "Freezing the Image (Freeze)" [p.91](#)
- A/V Mute
 - ☛ "Hiding the Image and Sound Temporarily (A/V Mute)" [p.90](#)
- E-Zoom
 - ☛ "Enlarging Part of the Image (E-Zoom)" [p.92](#)

Image File Display Settings and Slideshow Operation Settings

You can set the file display order and Slideshow operations on the Option screen.

- 1** Select **Option** at the bottom of the file list screen, and then press the [Enter] button.

- 2** When the following Option screen is displayed, set each of the items.

Enable the settings by positioning the cursor on the target item and pressing the [Enter] button.

The following table shows the details for each item.

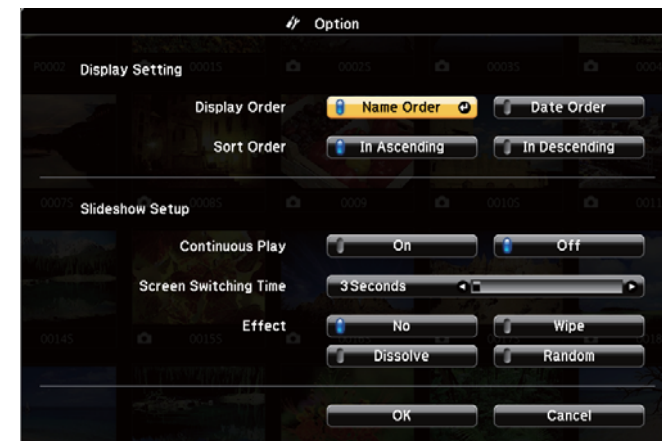

Display Order	You can select to display the files in Name Order or Date Order .
Sort Order	You can select to sort the files In Ascending or In Descending order.
Continuous Play	You can set whether to repeat the Slideshow.
Screen Switching Time	You can set the time for a single file to be displayed in Play Slideshow. You can set a time between No (0) to 60 seconds. When you set No , auto play is disabled.
Effect	You can set the screen effects when changing slides.

3 Use the [↶], [↷], [↵], and [↶] buttons to position the cursor over **OK**, and then press the [Enter] button.

The settings are applied.

If you do not want to apply the settings, position the cursor on **Cancel**, and then press the [Enter] button.

Flipping the Image Horizontally (Flip Horizontal)

You can temporarily flip the image horizontally and project.

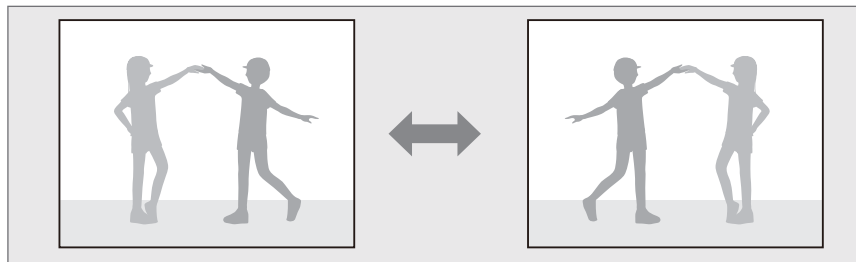

When **User Button** is set to **Flip Horizontal** from the Configuration menu, each time you press the [User] button, Flip Horizontal turns on or off.

☛ **Settings - User Button** p.119

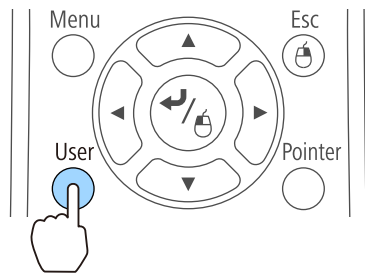

- In the following situations, Flip Horizontal turns off.
 - When the projector is off
 - When the Configuration menu is displayed
 - When the projector's **Projection** mode is changed
 - When performing Keystone
 - When Message Broadcasting is running
- The interactive function does not operate correctly during Flip Horizontal (EB-536Wi only).

Hiding the Image and Sound Temporarily (A/V Mute)

You can switch off the image on the screen when you want to focus the audience's attention on what you are saying, or when you do not want to display operations such as changing files.

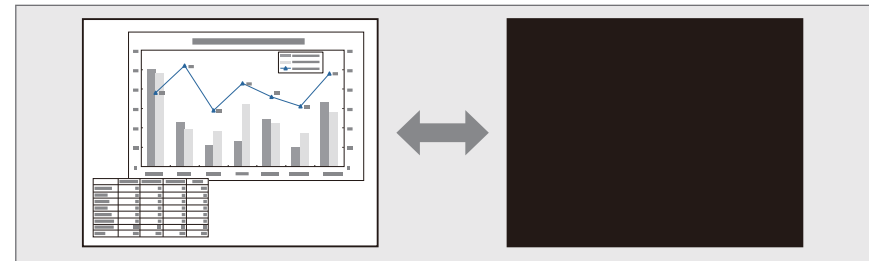

Each time you press the [A/V Mute] button, A/V Mute turns on or off.

Remote control

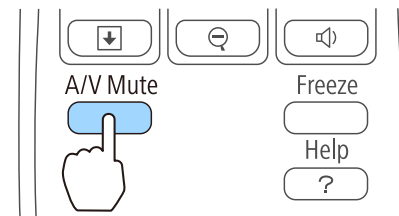

Top of projector

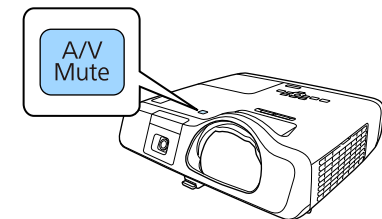



- If you use this function when projecting moving images, the images and sound continue to be played back by the source, and you cannot return to the point where A/V Mute was activated.
- Microphone audio is still output even when A/V Mute is turned on.
- You can select the screen displayed when the [A/V Mute] button is pressed from the Configuration menu.
 - ☛ **Extended - Display - A/V Mute** p.120
- When A/V mute is enabled with the [A/V Mute] button, **A/V Mute Timer** activates and the power is automatically turned off after approximately 30 minutes. If you do not want to enable A/V Mute Timer, set **A/V Mute Timer** to **Off**.
 - ☛ **ECO - A/V Mute Timer** p.133
- The lamp is still lit during A/V Mute, so the lamp hours continue to accumulate.



- Audio does not stop.
- When projecting moving images, the images continue to be played back while the screen is frozen. It is not possible to resume projection from the point where the screen was frozen.
- If the [Freeze] button is pressed while the Configuration menu or the Help screen is displayed, the menu or the Help screen that is displayed is closed.
- Freeze still works while E-Zoom is being used.

Freezing the Image (Freeze)

When Freeze is activated on moving images, the frozen image continues to project on the screen, so you can project a moving image one frame at a time like a still photo. Also, you can perform operations such as changing between files during presentations from a computer without projecting any images if the Freeze function is activated beforehand.

Each time you press the [Freeze] button, Freeze turns on or off.

Remote control

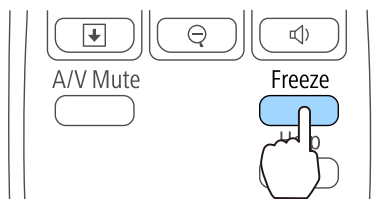

Pointer Function (Pointer)

This allows you to move a Pointer icon on the projected image, and helps you draw attention to the area you are talking about.

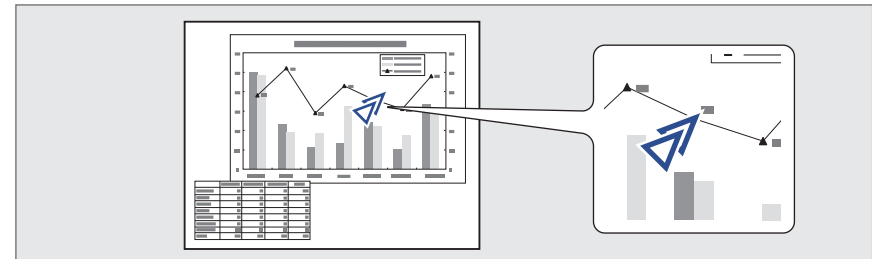

1

Display the Pointer.

Each time you press the [Pointer] button, the pointer appears or disappears.

Remote control

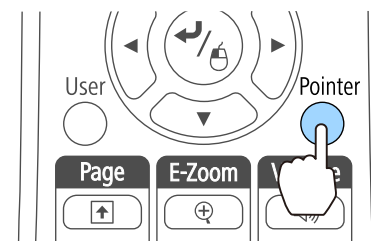

2 Move the Pointer icon (↗).

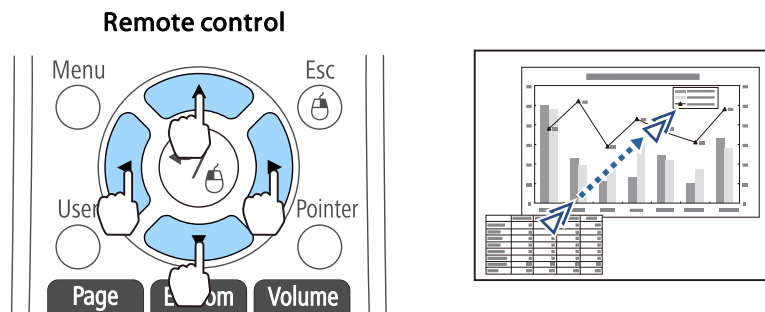

When any pair of adjacent [◀▶], [⏪⏩], [◀], or [▶] buttons are pressed at the same time, the pointer can be moved diagonally.

 You can select the shape of the pointer icon from the Configuration menu.
 🖱️ **Settings - Pointer Shape** p.119

Enlarging Part of the Image (E-Zoom)

This is useful when you want to expand images to see them in greater detail, such as graphs and tables.

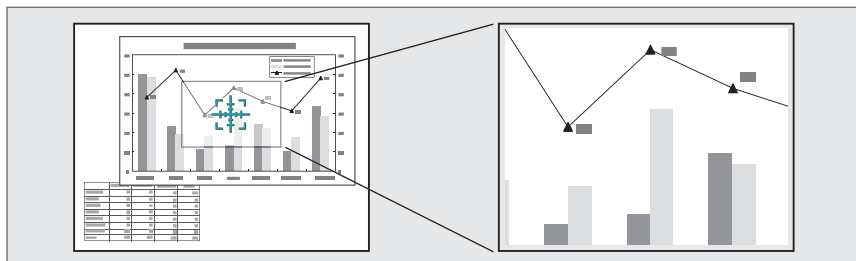

1 Start E-Zoom.

Press the [⊕] button to display the Cross (⊕).

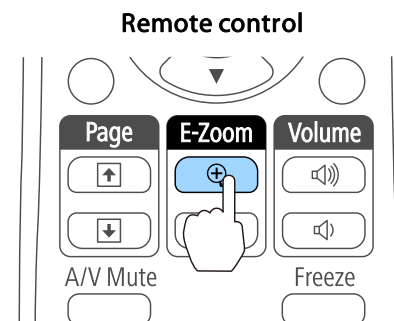

2 Move the Cross (⊕) to the area of the image that you want to enlarge.

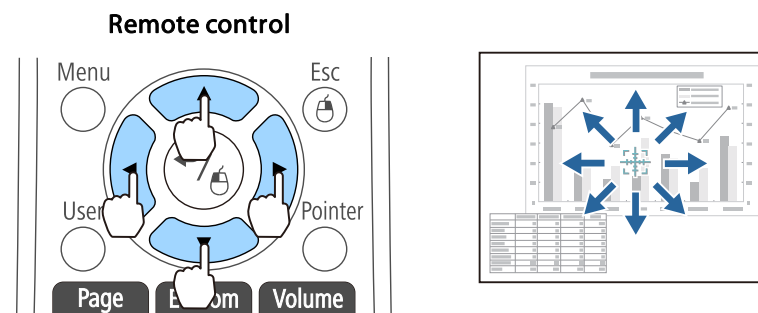

When any pair of adjacent [◀▶], [⏪⏩], [◀], or [▶] buttons are pressed at the same time, the pointer can be moved diagonally.

3 Enlarge.

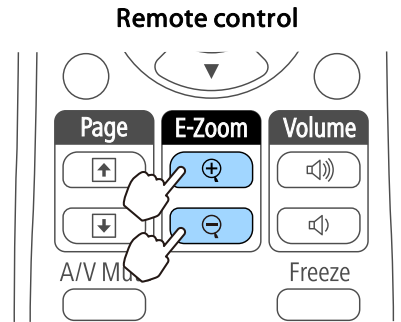

[+] button: Expands the area each time it is pressed. You can expand quickly by holding the button down.

[-] button: Reduces images that have been enlarged.

[Esc] button: Cancels E-Zoom.

- The enlargement ratio appears on the screen. The selected area can be enlarged to between 1 to 4 times in 25 incremental steps.
- During enlarged projection, press the [▲], [▼], [◀], and [▶] buttons to scroll the image.

Using the Remote Control to Operate the Mouse Pointer (Wireless Mouse)

You can control the computer's mouse pointer from the projector's remote control. This function is called Wireless Mouse.

The following operating systems are compatible with Wireless Mouse.

	Windows	OS X
OS	Windows 2000 Windows XP Windows Vista Windows 7 Windows 8 Windows 8.1	Mac OS X 10.3.x Mac OS X 10.4.x Mac OS X 10.5.x Mac OS X 10.6.x OS X 10.7.x OS X 10.8.x OS X 10.9.x

* It may not be possible to use the Wireless Mouse function under some versions of the operating systems.

Use the following procedure to enable the Wireless Mouse function.

- 1 Set **USB Type B** to **Wireless Mouse/USB Display** from the Configuration menu (EB-536Wi only).
 - ☛ **Extended - USB Type B** p.120
- 2 Connect the projector to the computer with the supplied or a commercially available USB cable.
 - ☛ "Connecting a Computer" p.26
- 3 Change the source to one of the following.
 - USB Display
 - Computer1
 - Computer2
 - HDMI
 - ☛ "Switching to the Target Image Using the Remote Control" p.44

Once set, the mouse pointer can be controlled as follows.

Moving the mouse pointer

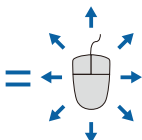
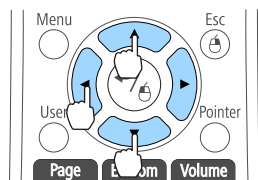

[Up], [Down], [Left], or [Right] buttons:

Moves the mouse pointer.

Mouse clicks

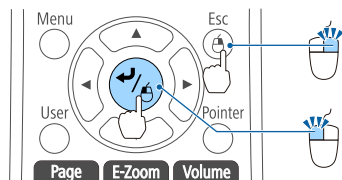

[Esc] button: Right click.

[Enter] button: Left click. Press quickly twice to double-click.

Drag and drop

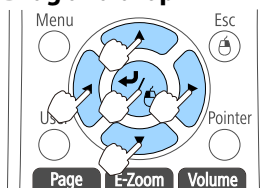

While holding down the [Enter] button, press the [Up], [Down], [Left], or [Right] button to drag.

Release the [Enter] button to drop at the desired location.

Page Up/Down

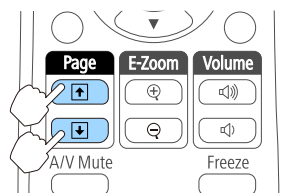

[Page Up] button: Moves to the previous page.

[Page Down] button: Moves to the next page.



- When any pair of adjacent [Up], [Down], [Left], or [Right] buttons are pressed at the same time, the pointer can be moved diagonally.
- If the mouse button settings are set to reverse on the computer, the operation of the remote control buttons will also be reversed.
- The Wireless Mouse function does not work under the following conditions.
 - When **Extended - USB Type B** is set to anything other than **Wireless Mouse/USB Display** (EB-536Wi only).
 - When displaying the Configuration menu or help.
 - When operating functions other than the Wireless Mouse function (such as adjusting the volume)
 However, when using the E-Zoom or Pointer function, the page up or down function is available.

Saving a User's Logo

You can save the image that is currently being projected as a User's Logo.

You can use the registered user's logo as a display when projection starts or no image signal is being input.

☛ **Extended - Display** p.120



- Once a User's Logo has been saved, the logo cannot be returned to the factory default.
- If the content of the Configuration menu is set from another projector using the batch setup function, the registered User's Logo is set for the other projectors. Do not register confidential information and so on as the User's Logo.
- ☛ "Performing Batch Setup for Multiple Projectors" p.136

1 Project the image you want to save as the User's Logo, and then press the [Menu] button.

☛ "Using the Configuration Menu" p.113

Using the remote control

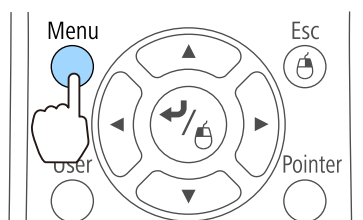

Using the control panel

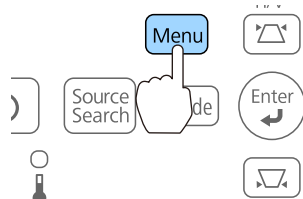

2 Select **User's Logo** from **Extended**.

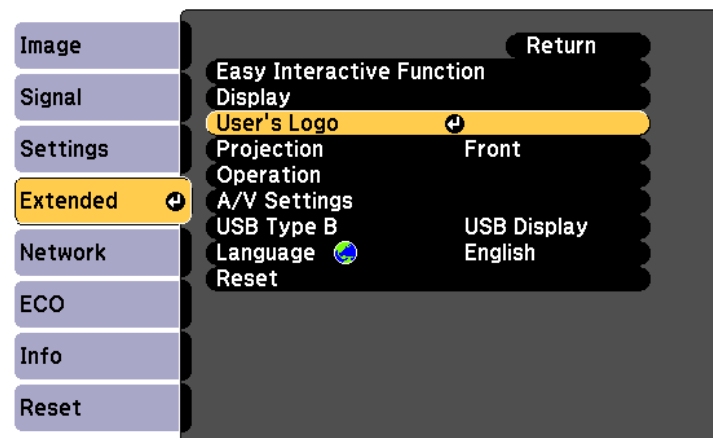

- When **User's Logo Protection** from **Password Protection** is set to **On**, a message is displayed and the User's Logo cannot be changed. You can make changes after setting **User's Logo Protection** to **Off**.
- ☛ "Managing Users (Password Protection)" p.98
- If **User's Logo** is selected when Keystone, E-Zoom, Aspect, or Adjust Zoom are being performed, the function currently being performed is temporarily cancelled.

3 When the message "Choose this image as the User's Logo?" is displayed, select **Yes**.



When you press the [Enter] button on the remote control or the control panel, the screen size may change depending on the signal to match the actual resolution of the image signal.

- 4** Move the box to select the part of the image to use as the User's Logo.

You can perform the same operations from the projector's control panel.

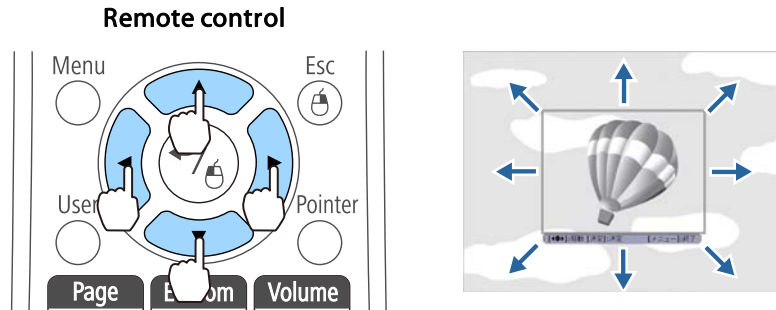

 You can save at 400 x 300 dots in size.

- 5** When you press the [Enter] button and the message "Select this image?" is displayed, select **Yes**.

- 6** Select the zoom factor from the zoom setting screen.

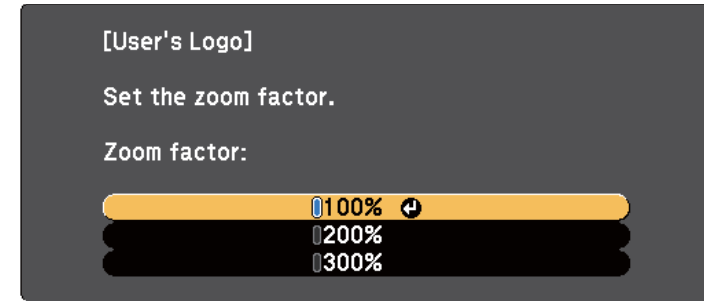

- 7** When the message "Save this image as the User's Logo?" is displayed, select **Yes**.

The image is saved. After the image has been saved, the message "Completed." is displayed.

 When a User's Logo is saved, the previous User's Logo is erased.

Saving User Pattern

There are five types of patterns registered to the projector, such as ruled lines and grid patterns.

 **Settings - Pattern - Pattern Type** [p.119](#)

You can also save the image that is currently being projected as a User Pattern.

 When a User Pattern is saved, the previous User Pattern is erased.

- 1 Project the image you want to use as the User Pattern, and then press the [Menu] button.

☛ "Using the Configuration Menu" p.113

Using the remote control

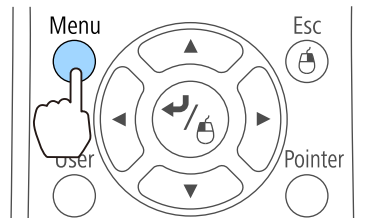

Using the control panel

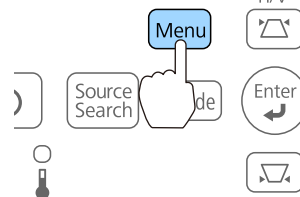

- 2 Select **Pattern** from **Settings**.

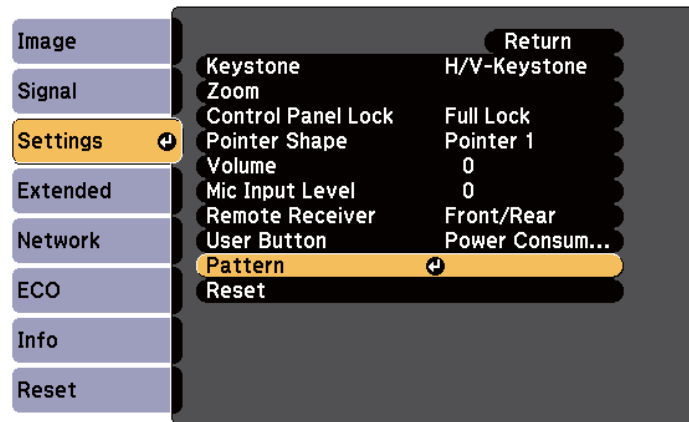

- 3 Select **User Pattern**.

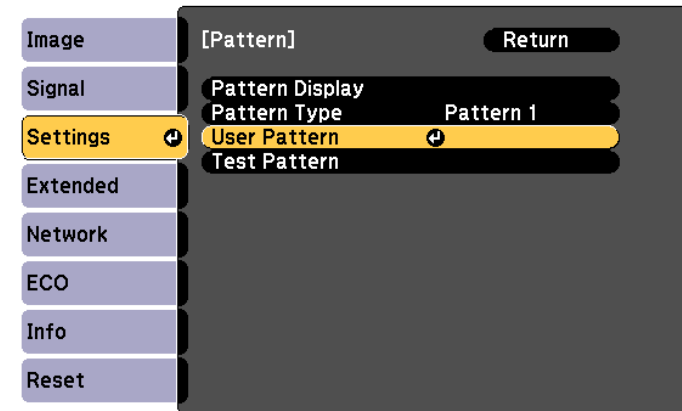

If **User Pattern** is selected when Keystone, E-Zoom, Aspect, or Adjust Zoom is being performed, the function currently being performed is cancelled.

- 4 When "Do you want to use the currently projected image as the User Pattern?" is displayed, select **Yes**.

- 5 When you press the [↵] button, the message "Do you save this image as the User Pattern?" is displayed. Select **Yes**.

The image is saved. After the image has been saved, the message "The User Pattern setting is complete." is displayed.



Once a User Pattern has been saved, User Pattern cannot be returned to the factory default.

The projector has the following enhanced security functions.

- **Password Protection**
You can limit who can use the projector.
- **Control Panel Lock**
You can prevent people changing the settings on the projector without permission.
☛ "Restricting Operation (Control Panel Lock)" [p.100](#)
- **Anti-Theft Lock**
The projector is equipped with the following anti-theft security device.
☛ "Anti-Theft Lock" [p.101](#)

Managing Users (Password Protection)

When Password Protection is activated, people who do not know the password cannot use the projector to project images even if the projector power is on. Furthermore, the user's logo that is displayed when you turn on the projector cannot be changed. This acts as an anti-theft device as the projector cannot be used even if it is stolen. At the time of purchase, Password Protection is not activated.

Kinds of Password Protection

The following three kinds of Password Protection settings can be made according to how the projector is being used.

- **Power On Protection**
When **Power On Protection** is **On**, you need to enter a preset password after the projector is plugged in and turned on (this also applies to Direct Power On). When the correct password is entered, projection starts.

- **User's Logo Protection**

Even if someone tries to change the User's Logo set by the owner of the projector, it cannot be changed. When **User's Logo Protection** is set to **On**, the following setting changes for the User's Logo are prohibited.

- Capturing a User's Logo
- Setting **Display Background**, **Startup Screen**, or **A/V Mute** from **Display**
☛ **Extended - Display** [p.120](#)

- **Network Protection**

When **Network Protection** is set to **On**, changing the settings for **Network** is prohibited.

- ☛ "Network Menu" [p.124](#)

Setting Password Protection

Use the following procedure to set Password Protection.

- 1** During projection, hold down the [Freeze] button for about five seconds.

The Password Protection setting menu is displayed.

Remote control

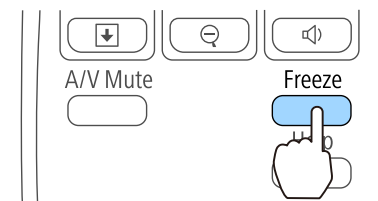



- If Password Protection is already activated, you must enter the password.
If the password is entered correctly, the Password Protection setting menu is displayed.
- "Entering the Password" p.99
- When the password is set, stick the supplied password protect sticker in a visible position on the projector as a further theft deterrent.

- 2 Select the type of Password Protection you want to set, and then press the [Enter] button.

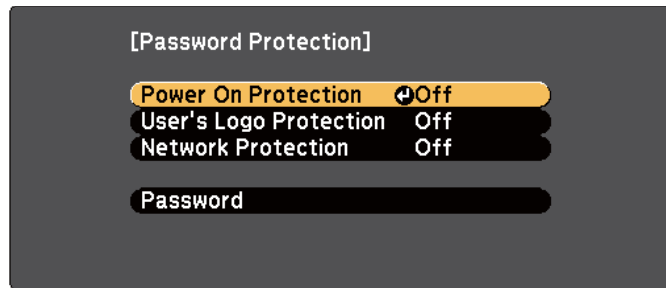

- 3 Select **On**, and then press the [Enter] button.
Press the [Esc] button, the screen displayed in step 2 is displayed again.

- 4 Set the password.
 - (1) Select **Password**, and then press the [Enter] button.
 - (2) When the message "Change the password?" is displayed, select **Yes** and then press the [Enter] button. The default password is set to "0000". Change this to your own desired Password. If you select **No**, the screen displayed in step 2 is displayed again.
 - (3) While holding down the [Num] button, enter a four digit number using the numeric buttons. The number entered is displayed as "****". When you enter the fourth digit, the confirmation screen is displayed.

Remote control

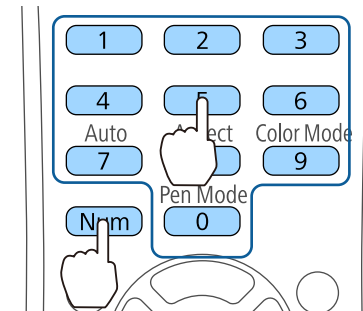

- (4) Re-enter the password.
The message "Password accepted." is displayed.
If you enter the password incorrectly, a message is displayed prompting you to re-enter the password.

Entering the Password

When the password entry screen is displayed, enter the password using the remote control.

While holding down the [Num] button, enter the password by pressing the numeric buttons.

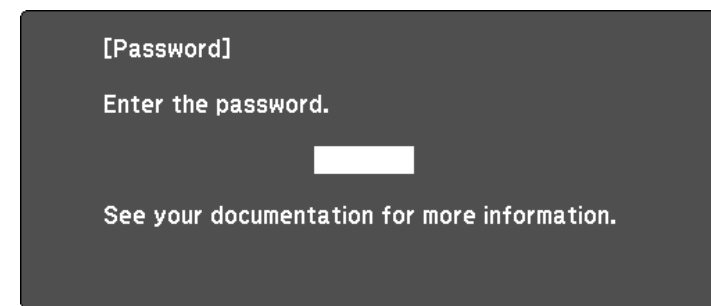

When you enter the correct password, Password Protection is temporarily released.

Attention

- If an incorrect password is entered three times in succession, the message "The projector's operation will be locked." is displayed for approximately five minutes, and then the projector switches to standby mode. If this happens, disconnect the power plug from the electrical outlet and then reinsert it and turn the projector's power back on. The projector displays the password entry screen again so that you can enter the correct password.
- If you have forgotten the password, make a note of the "Request Code: xxxxx" number that appears on the screen and contact the nearest address provided in the Epson Projector Contact List.
[Epson Projector Contact List](#)
- If you continue to repeat the above operation and input the wrong Password 30 times in succession, the following message is displayed and the projector does not accept any more Password entries. "The projector's operation will be locked. Contact Epson as described in your documentation."
[Epson Projector Contact List](#)

Restricting Operation (Control Panel Lock)

Do one of the following to lock the operation buttons on the control panel.

- **Full Lock**
All of the buttons on the control panel are locked. You cannot perform any operations from the control panel, including turning the power on or off.
- **Partial Lock**
All of the buttons on the control panel, except for the [⏻] power button, are locked.

This is useful at events or shows when you want to deactivate all buttons during projection or at schools when you want to limit button operation. The projector can still be operated using the remote control.

- 1 Press the [Menu] button while projecting.
 "Using the Configuration Menu" [p.113](#)

Using the remote control

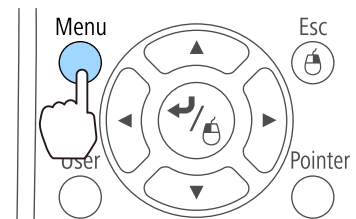

Using the control panel

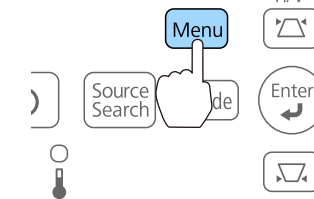

- 2 Select **Control Panel Lock** from **Settings**.

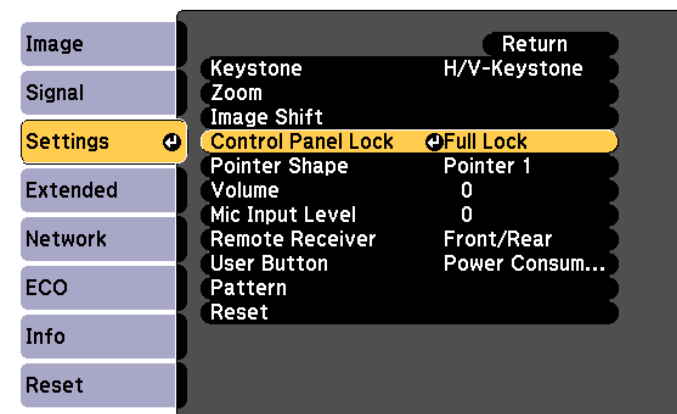

- 3 Select either **Full Lock** or **Partial Lock** according to your purpose.

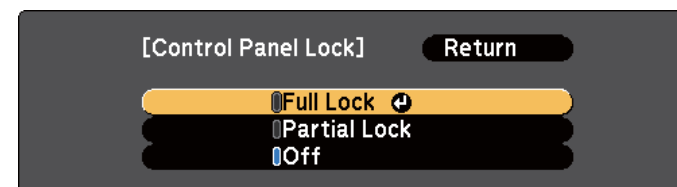

- 4** Select **Yes** when the confirmation message is displayed.
The control panel buttons are locked according to the setting you chose.



You can release the control panel lock by one of the following two methods.

- Select **Off** from **Control Panel Lock**.
 - **Settings - Control Panel Lock** [p.119](#)
- Press and hold down the [Enter] button on the control panel for about seven seconds, a message is displayed and the lock is released.

Anti-Theft Lock

The projector is equipped with the following types of anti-theft security devices.

- **Security slot**
The security slot is compatible with the Microsaver Security System manufactured by Kensington.
See the following for more details on the Microsaver Security System.
• <http://www.kensington.com/>
- **Security cable installation point**
A commercially available theft-prevention wire lock can be passed through the installation point to secure the projector to a desk or pillar.
Do not pass drop-prevention wires through here when mounting the projector on a wall or suspending it from a ceiling.

Installing the Wire Lock

Pass an anti-theft wire lock through the installation point.

See the documentation supplied with the wire lock for locking instructions.

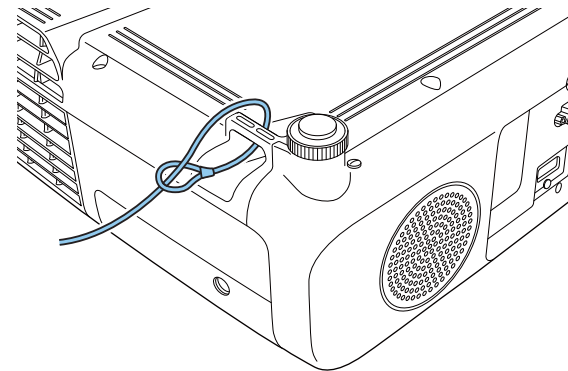

About EasyMP Monitor

EasyMP Monitor lets you carry out operations such as checking the status of multiple Epson projectors that are connected to a network at a computer monitor, and controlling the projectors from the computer.

You can download EasyMP Monitor from the following Web site.

<http://www.epson.com>

The following provides descriptions of the monitoring and control functions that can be carried out using EasyMP Monitor.

- Registering projectors for monitoring and control
- Group registration for registered projectors
- Monitoring the status of registered projectors
- Controlling registered projectors
- Mail Notification settings
- Sending messages to registered projectors

Message Broadcasting

Message Broadcasting is plugin software for EasyMP Monitor. Message Broadcasting can be used to send a message (JPEG file) to project on all Epson projectors or specified projectors connected on the network. The data can be sent manually, or sent automatically using Timer Settings of EasyMP Monitor.

Download the Message Broadcasting software from the following Web site.

<http://www.epson.com>

Changing Settings Using a Web Browser (Web Control)

By using a Web browser of a computer connected to the projector on a network, you can set the projector's functions and control the projector.

This function allows you to perform setup and control operations remotely. In addition, since you can use the computer's keyboard, entering characters required for the setup is easier.

Use Microsoft Internet Explorer 8.0 or later as the Web browser. Use Safari for OS X.



If you set **Standby Mode** to **Communication On**, you can use the Web browser to make settings and perform control even if the projector is in standby mode (when the power is off).

☛ **ECO - Standby Mode** p.133

Projector Setup

In a Web browser, you can set items that are usually set in the projector's Configuration menu. The settings are reflected in the Configuration menu. There are also items that can only be set in the Web browser.

Items in the Configuration menu that cannot be set by the Web browser

- Settings menu - Pointer Shape
- Settings menu - Pattern (except Pattern Type)
- Settings menu - User Button
- Extended menu - User's Logo
- Extended menu - USB Type B
- Extended menu - Easy Interactive Function
- Extended menu - Language
- Reset menu - Reset All and Reset Lamp Hours

The settings for items on each menu are the same as the projector's Configuration menu.

☛ "Configuration Menu" p.112

Items that can Only Be Set with a Web Browser

- SNMP Community Name (up to 32 single-byte alphanumeric characters)

- Monitor Password (up to 16 single-byte alphanumeric characters)

Displaying the Web Control Screen

Use the following procedure to display the Web Control screen.

Make sure the computer and projector are connected to the network. Use Advanced when connecting via a Wireless LAN.



If your Web browser is set up to connect via a proxy server, the Web Control screen cannot be displayed. To display Web Control, you need to make settings so that a proxy server is not used for a connection.

- 1** Start a Web browser on the computer.
- 2** Enter the IP address of the projector in the address input box of the Web browser, and press the Enter key on the computer's keyboard.

The Web Control screen is displayed.

When **Web Control Password** is set from the Configuration menu, the password entry screen is displayed.

- 3** Enter the User ID and Password, and then press the Enter key on your computer's keyboard.

The User ID is "EPSONWEB".

The default password is "admin".

When the correct user ID and password are entered, the Web control screen is displayed.



- Enter the user ID even if the password setting is disabled. You cannot change the user ID.
- You can change the password on the Network menu from the Configuration menu.
 - ☛ **Network - Basic - Web Control Password** p.124

Displaying the Web Remote screen

The Web Remote function allows you to perform projector remote control operations with a Web browser.

- 1** Display the Web Control screen.
- 2** Click **Web Remote**.

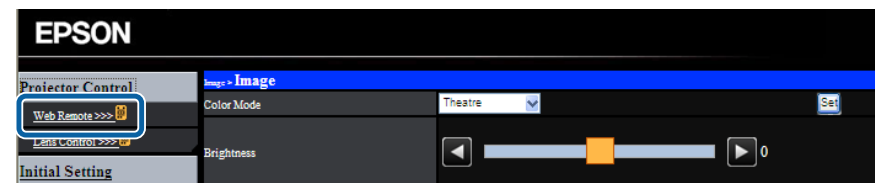

- 3** The Web Remote screen is displayed.

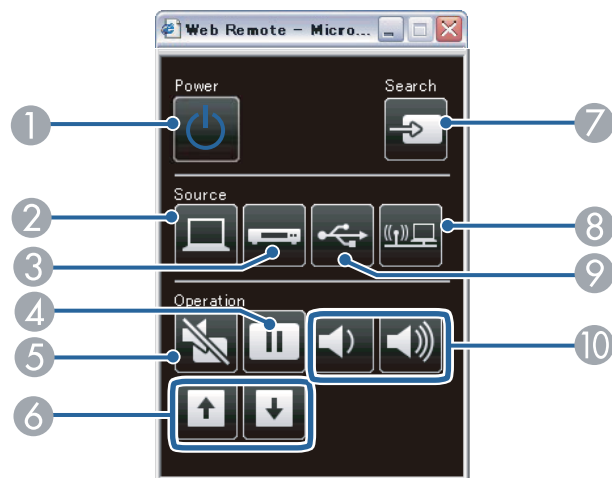

Name	Function
① [Power] button [⏻]	Turns the projector power on or off. ☛ "Turning On the Projector" p.41
② [Computer] button	Each time the button is pressed, it cycles through the following images: <ul style="list-style-type: none"> • Computer1 port • Computer2 port
③ [Video] button	Each time the button is pressed, it cycles through the images being input from the following sources. <ul style="list-style-type: none"> • S-Video port • Video port • HDMI port
④ [Freeze] button	Pauses or resumes image playback. ☛ "Freezing the Image (Freeze)" p.91
⑤ [A/V Mute] button	Turns the video and audio on or off. ☛ "Hiding the Image and Sound Temporarily (A/V Mute)" p.90

Name	Function
⑥ [Page] buttons [Up] [Down]	Changes pages in files such as PowerPoint files when using the following projection methods. <ul style="list-style-type: none"> • When using the Wireless Mouse function <ul style="list-style-type: none"> ☛ "Using the Remote Control to Operate the Mouse Pointer (Wireless Mouse)" p.93 • When using USB Display <ul style="list-style-type: none"> ☛ "Projecting with USB Display" p.45 • When connecting to a network When projecting images using PC Free, pressing these buttons displays the previous/next screen.
⑦ [Source Search] button	Switches to the image from the input port where video signals are being input. ☛ "Automatically Detect Input Signals and Change the Projected Image (Source Search)" p.43
⑧ [LAN] button	Switches to the image from the network connected device. ☛ "Switching to the Target Image Using the Remote Control" p.44
⑨ [USB] button	Each time the button is pressed, it cycles through the following images: <ul style="list-style-type: none"> • USB Display • Images from the device connected to the USB-A port ☛ "Switching to the Target Image Using the Remote Control" p.44
⑩ [Volume] button [🔊] [🔇]	[🔊] Decreases the volume. [🔇] Increases the volume. ☛ "Adjusting the Volume" p.53

Using the Mail Notification Function to Report Problems

When you set Mail Notification, notification messages are sent to the preset email addresses when a problem or warning occurs with a projector. This

will enable the operator to be notified of problems with projectors even at locations away from the projectors.

☛ Network - Mail - Mail Notification [p.131](#)



- Up to three notification destinations (addresses) can be registered, and notification messages can be sent to all three destinations at once.
- If a projector develops a critical problem and suddenly stops working, it may not be able to send a message notifying an operator of the problem.
- Controlling is possible if **Standby Mode** is set to **Communication On**, even if the projector is in standby state (when the power is off).

☛ ECO - Standby Mode [p.133](#)

Reading Error Notification Mail

When the Mail Notification function is set to On and a problem or warning occurs in the projector, the following email will be sent.

Sender: Email Address 1

Email title: EPSON Projector

Line 1: The projector name where the problem has occurred

Line 2: The IP address set for the projector where the problem has occurred

Line 3 and on: Details of the problem

The details of the problem are listed line by line. The main message contents are listed below.

- Internal error
- Fan related error
- Sensor error

- Lamp timer failure
- Lamp out
- Internal temperature error
- High-speed cooling in progress
- Lamp replacement notification
- No-signal
No Signal is input to the projector. Check the connection status or check that the power for the signal source is turned on.
- Auto Iris Error
- Power Err. (Ballast)

See the following to deal with problems or warnings.

☛ "Reading the Indicators" [p.143](#)

Management Using SNMP

By setting **SNMP** to **On** in the Configuration menu, notification messages are sent to the specified computer when a problem or warning occurs. This will enable the operator to be notified of problems with projectors even at locations away from the projectors.

☛ Network - Others - SNMP [p.132](#)



- SNMP should be managed by a network administrator or someone who is familiar with the network.
- To use the SNMP function to monitor the projector, you need to install the SNMP manager program on your computer.
- The SNMP Agent for this projector complies with version 1 (SNMPv1).
- The managing function using SNMP cannot be used via wireless LAN in Quick mode.
- Up to two destination IP addresses can be saved.

ESC/VP21 Commands

You can control the projector from an external device using ESC/VP21.

Command list

When the power ON command is transmitted to the projector, the power turns on and it enters warm-up mode. When the projector's power has turned on, a colon ":" (3Ah) is returned.

When a command is input, the projector executes the command and returns a ":", and then accepts the next command.

If the command being processed terminates abnormally, an error message is output and a ":" is returned.

The main contents are listed below.

Item		Command	
Power ON/OFF	On	PWR ON	
	Off	PWR OFF	
Signal selection	Computer1	Auto	SOURCE 1F
		RGB	SOURCE 11
		Component	SOURCE 14

Item		Command	
Computer2	Auto	SOURCE 2F	
	RGB	SOURCE 21	
	Component	SOURCE 24	
	HDMI		SOURCE 30
	Video		SOURCE 41
	S-Video		SOURCE 42
	USB Display		SOURCE 51
	USB		SOURCE 52
	LAN		SOURCE 53
A/V Mute ON/OFF	On	MUTE ON	
	Off	MUTE OFF	

Add a Carriage Return (CR) code (0Dh) to the end of each command and transmit.

For more details, contact your local dealer or the nearest address provided in the Epson Projector Contact List.

 [Epson Projector Contact List](#)

Cable Layouts

Serial Connection

- Connector shape: D-Sub 9-pin (male)

- Projector input port name: RS-232C

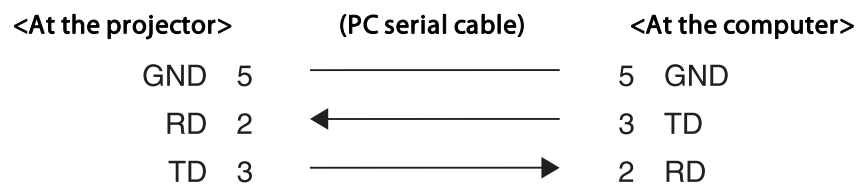
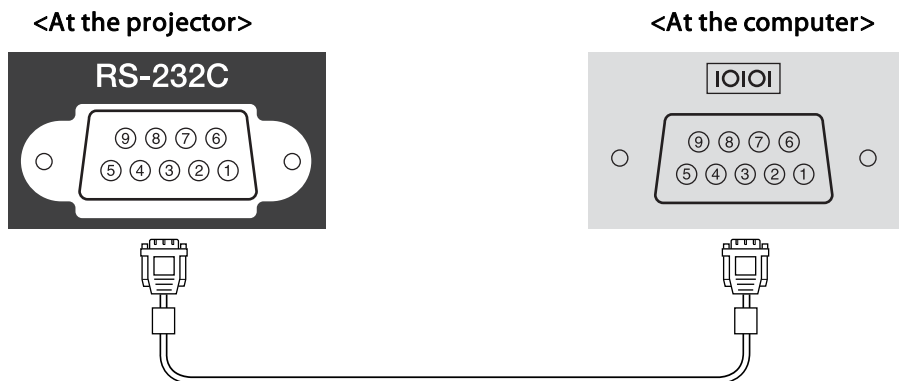

Signal Name	Function
GND	Signal wire ground
TD	Transmit data
RD	Receive data

Communications protocol

- Default baud rate setting: 9600 bps
- Data length: 8 bit
- Parity: None
- Stop-bit: 1 bit
- Flow control: None

About PJLink

PJLink Class1 was established by the JBMIA (Japan Business Machine and Information System Industries Association) as a standard protocol for controlling network-compatible projector's as part of their efforts to standardize projector control protocols.

The projector complies with the PJLink Class1 standard established by the JBMIA.

You need to make network settings before you can use PJLink. See the following for more information on network settings.

☛ "Network Menu" [p.124](#)

It complies with all commands except for the following commands defined by PJLink Class1, and agreement was confirmed by the PJLink standard adaptability verification.

URL:<http://pjlink.jbmia.or.jp/english/>

- **Non-compatible commands**

	Function	PJLink Command
Mute settings	Image muting set	AVMT 11
	Audio muting set	AVMT 21

- **Input names defined by PJLink and corresponding projector sources**

Source	PJLink Command
Computer1	INPT 11
Computer2	INPT 12
Video	INPT 21
S-Video	INPT 22
HDMI	INPT 32
USB	INPT 41

Source	PJLink Command
LAN	INPT 52
USB Display	INPT 53

- Manufacturer name displayed for "Manufacture name information query"
EPSON
- Model name displayed for "Product name information query"
EPSON 536
EPSON 535
EPSON 525
EPSON 530
EPSON 520

About Crestron RoomView®

Crestron RoomView® is an integrated control system provided by Crestron®. It can be used to monitor and control multiple devices connected on a network.

The projector supports the control protocol, and can therefore be used in a system built with Crestron RoomView®.

Visit the Crestron® Web site for details on Crestron RoomView®. (Only English-language displays are supported.)

<http://www.crestron.com>

The following provides an overview of Crestron RoomView®.

• Remote operation using a Web browser

You can operate a projector from your computer just like using a remote control.

• Monitoring and control with application software

You can use Crestron RoomView® Express or Crestron RoomView® Server Edition provided by Crestron® to monitor devices in the system, to communicate with the help desk, and to send emergency messages. See the following Web site for details.

<http://www.crestron.com/getroomview>

This manual describes how to perform operations on your computer using a Web browser.



- You can only enter single-byte alphanumeric characters and symbols.
- The following functions cannot be used while using Crestron RoomView®.
 - ☛ "Changing Settings Using a Web Browser (Web Control)" [p.102](#)
Message Broadcasting (EasyMP Monitor plug-in)
 - Controlling is possible if **Standby Mode** is set to **Communication On**, even if the projector is in standby state (when the power is off).
 - ☛ **ECO - Standby Mode** [p.133](#)

Operating a Projector from Your Computer

Displaying the Operation Window

Check the following before carrying out any operations.

- Make sure the computer and projector are connected to the network. When communicating with a wireless LAN, connect in Advanced connection mode.
 - ☛ "Wireless LAN Menu" [p.127](#)
- Set **Crestron RoomView** to **On** from the **Network** menu.
 - ☛ **Network - Others - Crestron RoomView** [p.132](#)

- 1 Start a Web browser on the computer.
- 2 Enter the IP address of the projector in the address field of the Web browser, and press the Enter key on the keyboard.
The operation window is displayed.

Using the Operation Window

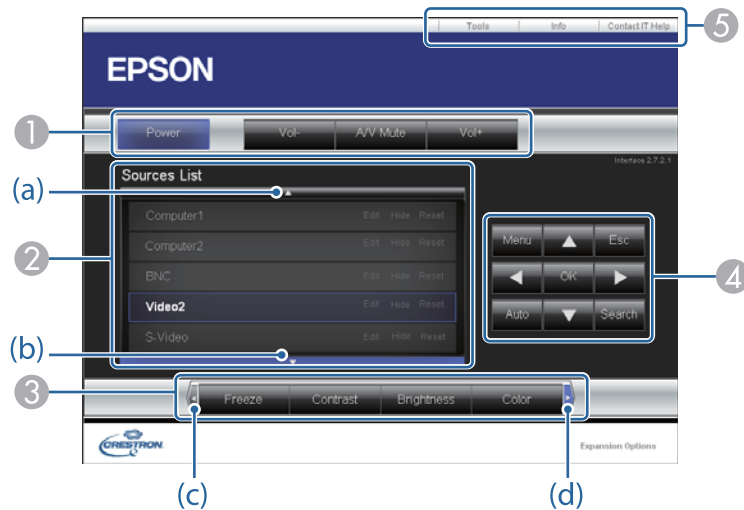

- 1 You can perform the following operations when you click the buttons.

Button	Function
Power	Turns the projector power on or off.
Vol-/Vol+	Adjusts the volume.

Button	Function
A/V Mute	Turns the video and audio on or off. ☛ "Hiding the Image and Sound Temporarily (A/V Mute)" p.90

- 2 Switch to the image from the selected input source. To display input sources that are not shown on the screen, click (a) or (b) to scroll up or down. The current video signal input source is displayed in blue.
You can change the source name if necessary.
- 3 You can perform the following operations when you click the buttons. To display buttons that are not shown on the screen, click (c) or (d) to scroll left or right.

Button	Function
Freeze	Images are paused or unpaused. ☛ "Freezing the Image (Freeze)" p.91
Contrast	You can adjust the difference between light and dark in the images.
Brightness	You can adjust the image brightness.
Color	You can adjust the color saturation for the images.
Sharpness	You can adjust the image sharpness.
Zoom	Click the [⊕] button to enlarge the image without changing the projection size. Click the [⊖] button to reduce an image that was enlarged with the [⊕] button. Click the [▲], [▼], [◀], or [▶] button to change the position of an enlarged image. ☛ "Enlarging Part of the Image (E-Zoom)" p.92

- 4 The [▲], [▼], [◀], and [▶] buttons perform the same operations as the [↔], [↕], [↶], and [↷] buttons on the remote control. You can perform the following operations when you click the other buttons.

Button	Function
OK	Performs the same operation as the [Enter] button on the remote control. ☛ "Remote Control" p.16
Menu	Displays and closes the Configuration menu.
Auto	If clicked while projecting analog RGB signals from Computer1 port or Computer2 port, automatically optimizes the image by adjusting the Tracking, Sync., and Position.
Search	Switches to the image from the input port where video signals are being input. ☛ "Automatically Detect Input Signals and Change the Projected Image (Source Search)" p.43
Esc	Performs the same operation as the [Esc] button on the remote control. ☛ "Remote Control" p.16

5 You can perform the following operations when you click the tabs.

Tab	Function
Contact IT Help	Displays the Help Desk window. Used to send messages to, and receive messages from, the administrator using Crestron RoomView® Express.
Info	Displays information on the projector that is currently connected.
Tools	Changes settings in the projector that is currently connected. See the next section.

Using the Tools Window

The following window is displayed when you click the **Tools** tab on the operation window. You can use this window to change settings in the projector that is currently connected.

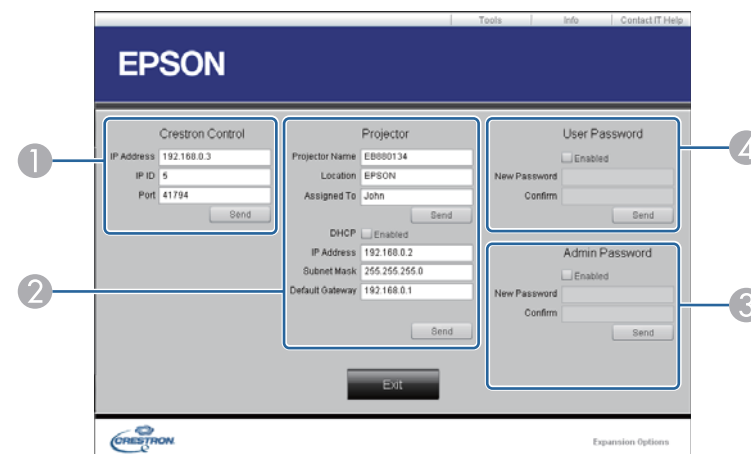

The screenshot shows the EPSON configuration interface with the following settings:

- 1. Crestron Control:** IP Address: 192.168.0.3, IP ID: 5, Port: 41794.
- 2. Projector:** Projector Name: EB000134, Location: EPSON, Assigned To: John, DHCP: Enabled, IP Address: 192.168.0.2, Subnet Mask: 255.255.255.0, Default Gateway: 192.168.0.1.
- 3. Admin Password:** Enabled checkbox, New Password field, Confirm field.
- 4. User Password:** Enabled checkbox, New Password field, Confirm field.

- 1 Crestron Control**
Make settings for Crestron® central controllers.
- 2 Projector**
The following items can be set.

Item	Function
Projector Name	Enter a name to differentiate the projector that is currently connected from other projectors on the network. (The name can contain up to 15 single-byte alphanumeric characters.)
Location	Enter an installation location name for the projector that is currently connected on the network. (The name can contain up to 32 single-byte alphanumeric characters and symbols.)
Assigned To	Enter a user name for the projector. (The name can contain up to 32 single-byte alphanumeric characters and symbols.)

Item	Function
DHCP	Select the Enabled check box to use DHCP. You cannot enter an IP address if DHCP is enabled.
IP Address	Enter the IP address to assign to the currently connected projector.
Subnet Mask	Enter a subnet mask for the currently connected projector.
Default Gateway	Enter the gateway address for the currently connected projector.
Send	Click this button to confirm the changes made to the Projector .

3 Admin Password

Select the **Enabled** check box to require a password to open the Tools window. The following items can be set.

Item	Function
New Password	Enter the new password when changing the password to open the Tools window. (The name can contain up to 26 single-byte alphanumeric characters.)
Confirm	Enter the same password as you entered in New Password . If the passwords are not the same, an error is displayed.
Send	Click this button to confirm the changes made to the Admin Password .

4 User Password

Select the **Enabled** check box to require a password to open the operation window on the computer. The following items can be set.

Item	Function
New Password	Enter the new password when changing the password to open the operation window. (Up to 26 single-byte alphanumeric characters)
Confirm	Enter the same password as you entered in New Password . If the passwords are not the same, an error is displayed.
Send	Click this button to confirm the changes made to the User Password .



Configuration Menu

This chapter explains how to use the Configuration menu and its functions.

This section explains how to use the Configuration menu.

Although steps are explained using the remote control as an example, you can perform the same operations from the control panel. Check the guide under the menu for the available buttons and their operations.

1 Display the Configuration menu screen.

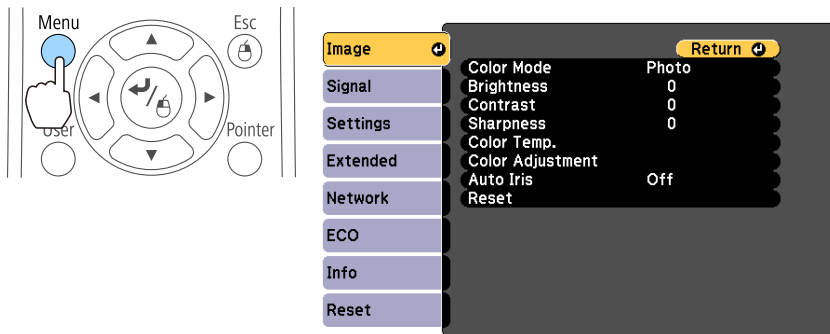

2 Select a top menu item.

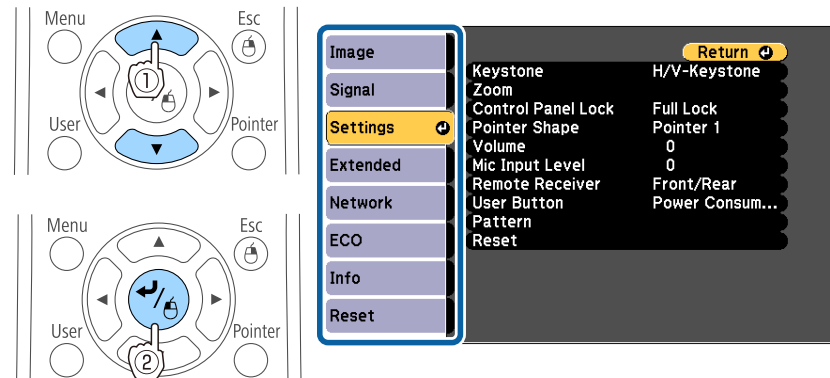

3 Select a submenu item.

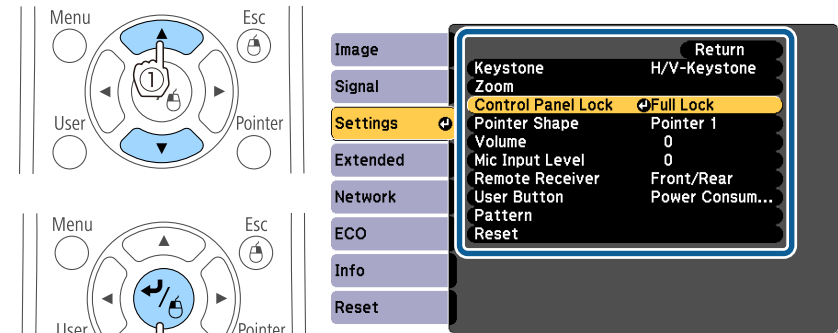

4 Change settings.

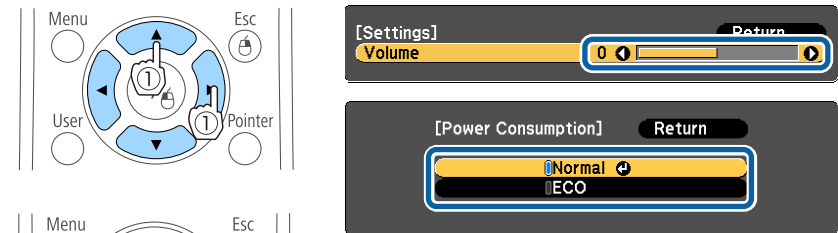

5 Press the [Menu] button to finish making settings.

Configuration Menu Table

Settable items vary depending on the model being used and the image signal and source being projected.

Top Menu Name	Submenu Name	Items or Setting Values
Image menu ☛ p.116	Color Mode	Dynamic, Presentation, Theatre, sRGB, Blackboard
	Brightness	-24 to 24
	Contrast	-24 to 24
	Color Saturation	-32 to 32
	Tint	-32 to 32
	Sharpness	-5 to 5
	Color Temp.	5000K to 10000K, -3 to 6
	Color Adjustment	Red: -16 to 16 Green: -16 to 16 Blue: -16 to 16
	Auto Iris	Off, Normal, High Speed
Signal menu ☛ p.117	Auto Setup	On and Off
	Resolution	Auto, Wide, and Normal
	Tracking	-
	Sync.	-
	Position	Up, Down, Left, and Right
	Progressive	Off, Video, and Film/Auto
	Noise Reduction	Off, NR1, and NR2
	HDMI Video Range	Auto, Normal, and Expanded
	Input Signal	Auto, RGB, and Component
Video Signal	Auto, NTSC, NTSC4.43, PAL, M-PAL, N-PAL, PAL60, and SECAM	

Top Menu Name	Submenu Name	Items or Setting Values
	Aspect	Normal, Auto, 4:3, 16:9, Full, Zoom, and Native
	Overscan	Auto, Off, 4%, and 8%
	Image Processing	Fine, Fast
Settings menu ☛ p.119	Keystone	H/V-Keystone and Quick Corner
	Zoom	0 (Wide) to 40 (Tele)
	Control Panel Lock	Full Lock, Partial Lock, and Off
	Pointer Shape	Pointer 1, Pointer 2, Pointer 3
	Volume	0 to 20
	Mic Input Level	0 to 5
	Remote Receiver	Front/Rear, Front, Rear, and Off
	User Button	Power Consumption, Info, Progressive, Test Pattern, Resolution, Mic Input Level, Pattern Display, Auto Calibration, Flip Horizontal
	Pattern	Pattern Display, Pattern Type, User Pattern, and Test Pattern
Extended menu ☛ p.120	Easy Interactive Function	Items in General Auto Calibration, Manual Calibration, Pen Mode, Hovering, Advanced Items in PC Interactive Pen Operation Mode, Enable Right Click, Advanced
	Display	Messages, Display Background, Startup Screen, A/V Mute, Toolbars, Pen Mode Icon, Projector Control
	User's Logo	-

Top Menu Name	Submenu Name	Items or Setting Values
	Projection	Front, Front/Ceiling, Rear, and Rear/Ceiling
	Operation	Direct Power On, High Altitude Mode, Startup Source Search, Auto Power On
	A/V Settings	A/V Output, Audio Output, HDMI Audio Output
	USB Type B	Easy Interactive Function, USB Display/Easy Interactive Function, Wireless Mouse/USB Display
	Language	15 or 35 languages*
ECO menu ☛ p.133	Power Consumption	Normal and ECO
	Light Optimizer	On and Off
	Sleep Mode	On and Off
	Sleep Mode Timer	1 to 30
	A/V Mute Timer	On and Off
	Standby Mode	Communication On and Communication Off
	ECO Display	On and Off
Info menu ☛ p.134	Projector Info	Lamp Hours, Source, Input Signal, Resolution, Video Signal, Refresh Rate, Sync Info, Status, Serial Number, Event ID
	Version	Main, Video
Reset menu ☛ p.135	Reset All	-
	Reset Lamp Hours	-

* The number of supported languages differs depending on the region where the projector is used.

Network menu

Top Menu Name	Submenu Name	Items or Setting Values
Basic menu ☛ p.126	Projector Name	-
	PJLink Password	-
	Web Control Password	-
	Projector Keyword	On and Off
Wireless LAN menu ☛ p.127	Connection Mode	Quick, Advanced
	Channel	1ch, 6ch, 11ch
	SSID Auto Setting	On and Off
	SSID	-
	Search Access Point	-
	IP Settings	DHCP, IP Address, Subnet Mask, and Gateway Address
	SSID Display	On and Off
Security menu ☛ p.129	Security	Off, WPA2-PSK, and WPA/WPA2-PSK
	Passphrase	-
Wired LAN menu ☛ p.130	IP Settings	DHCP, IP Address, Subnet Mask, and Gateway Address
	IP Address Display	On and Off
Mail menu ☛ p.131	Mail Notification	On and Off
	SMTP Server	-
	Port Number	-
	Address 1 Setting, Address 2 Setting, and Address 3 Setting	-
Others menu ☛ p.132	SNMP	On and Off

Top Menu Name	Submenu Name	Items or Setting Values
	Trap IP Address 1 and Trap IP Address 2	-
	Priority Gateway	Wired LAN and Wireless LAN
	AMX Device Discovery	On and Off
	Crestron RoomView	On and Off
	Bonjour	On and Off
	Message Broadcasting	On and Off

Image Menu

Settable items vary depending on the image signal and source currently being projected. Setting details are saved for each image signal.

 "Automatically Detect Input Signals and Change the Projected Image (Source Search)" [p.43](#)

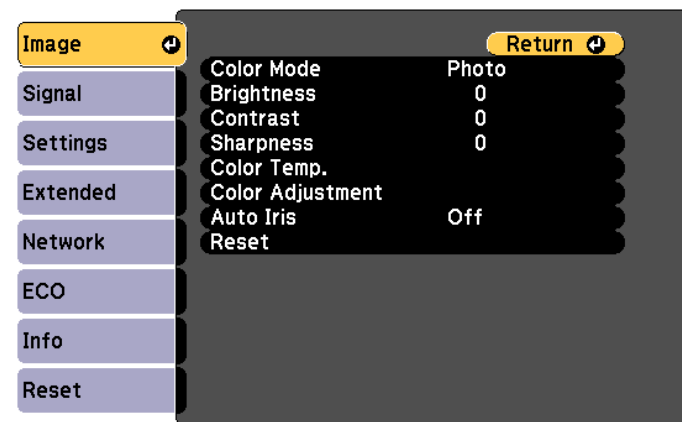

Submenu	Function
Color Mode	You can select the quality of the image to suit your surroundings.  "Selecting the Projection Quality (Selecting Color Mode)" p.53
Brightness	You can adjust the image brightness.
Contrast	You can adjust the difference between light and dark in the images.
Color Saturation	(Adjustment is only possible when component video or composite video images are being input.) You can adjust the color saturation for the images.
Tint	(Adjustment is possible when a component video signals are being input. Composite video and S-video input signals can only be adjusted when they are NTSC video signals.) You can adjust the image tint.
Sharpness	You can adjust the image sharpness.

Submenu	Function
Color Temp.	You can adjust the overall tint of the image. The image is tinted blue when a high value is selected and tinted red when a low value is selected. Values that can be adjusted depend on the Color Mode settings. For sRGB : From 5000K to 10000K in 10 steps For other settings: From -3 to 6 in 10 steps
Color Adjustment	(This item cannot be selected if Color Mode is set to sRGB .) You can adjust the color strength for Red , Green , and Blue individually.
Auto Iris	(This item can be set only if Color Mode is set to Dynamic or Theatre .) Set to Normal or High Speed to adjust the iris to obtain the optimum light for images being projected. Select High Speed to make faster iris corrections to match the speed of the scene. The setting is stored for each Color Mode. ☛ "Setting Auto Iris" p.54
Reset	You can reset all adjustment values for the Image menu to their default settings. See the following to return all menu items to their default settings. ☛ "Reset Menu" p.135

Signal Menu

Settable items vary depending on the image signal and source currently being projected. Setting details are saved for each image signal.

You cannot make settings on the Signal menu when the source is USB Display, USB, or LAN.

☛ "Automatically Detect Input Signals and Change the Projected Image (Source Search)" p.43

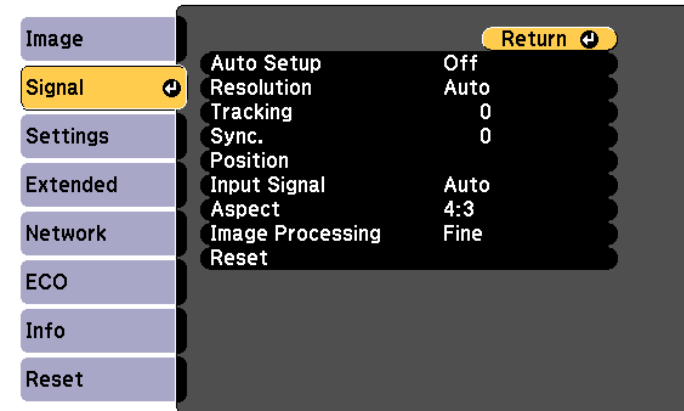

Submenu	Function
Auto Setup	(Only available when analog RGB computer signals are being input.) Set to On to automatically adjust Tracking, Sync., and Position to the optimum state when the input signal changes.
Resolution	(Only available when analog RGB computer signals are being input.) Set to Auto to automatically identify the resolution of the input signal. If images are not projected correctly when set to Auto , for example if some of the image is missing, adjust to Wide for wide screens, or set to Normal for 4:3 or 5:4 screens depending on the connected computer.





Submenu	Function
Tracking	(Only available when analog RGB computer signals are being input.) You can adjust computer images when vertical stripes appear in the images.
Sync.	(Only available when analog RGB computer signals are being input.) You can adjust computer images when flickering, fuzziness, or interference appear in the images.
Position	(This item cannot be set when the source is HDMI.) You can adjust the display position up, down, left, and right when a part of the image is missing so that the whole image is projected.
Progressive	<u>Interlace</u> (i) signal is converted to <u>Progressive</u> (p). (IP conversion) Off: Ideal for images with a large amount of movement. Video: Ideal for general video images. Film/Auto: This is ideal for movie films, computer graphics, and animation.
Noise Reduction	(This item cannot be set when Image Processing is set to Fast .) Smooths out rough images converted using progressive. There are two modes. Select your favorite setting. It is recommended that this is set to Off when viewing image sources in which noise is very low, such as for DVDs.
HDMI Video Range	When the projector's HDMI port is connected to a DVD player, set the projector's video range according to the DVD player's video range setting. If you are worried about floating black spots or washed out parts in the image, set to Expanded .
Input Signal	You can select the input signal from the Computer1 port or the Computer2 port. If set to Auto , the input signal is set automatically according to the connected equipment. If colors do not appear correctly when set to Auto , select the appropriate signal according to the connected equipment.

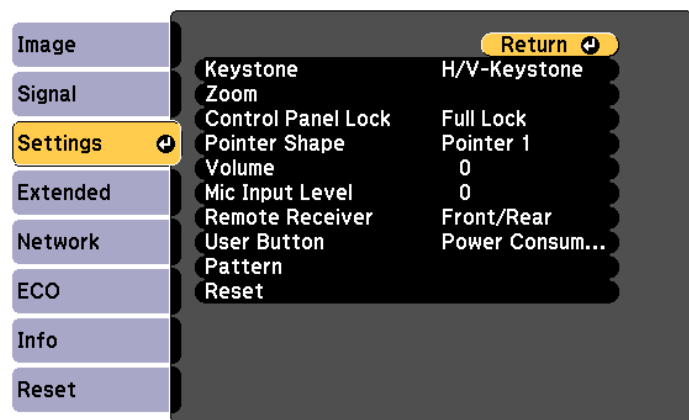





Submenu	Function
Video Signal	You can select the input signal from the S-Video port or the Video port. If set to Auto , video signals are recognized automatically. If interference appears in the image or a problem occurs such as no image is being projected when set to Auto , select the appropriate signal according to the connected equipment.
Aspect	You can set the <u>aspect ratio</u> for projected images. ☛ "Changing the Aspect Ratio of the Projected Image" p.55
Overscan	(This setting can only be adjusted when a component video signal is being input.) Changes the output image ratio (the range of the projected image). You can set the cropping range to Off , 4% , or 8% . You can select Auto when the source is HDMI. If you set to Auto , this setting is changed automatically depending on the source.
Image Processing	(This item cannot be selected if Easy Interactive Function is set to PC Interactive) When Fine is selected, priority is given to image quality, and the image is projected. When Fast is selected, priority is given to processing speed, and the image is projected. This improves the pen's tracking ability when using the interactive features (EB-536Wi only).
Reset	You can reset all adjustment values on the Signal menu to their default settings, except for Input Signal and Image Processing . See the following to return all menu items to their default settings. ☛ "Reset Menu" p.135

Settings Menu



Submenu	Function
Keystone	<p>You can correct keystone distortion.</p> <ul style="list-style-type: none"> When H/V-Keystone is selected: <ul style="list-style-type: none"> Adjust V-Keystone and H-Keystone to correct horizontal and vertical keystone distortion. You can also set H-Keystone Adjuster and Auto V-Keystone to On or Off (EB-536Wi only). <ul style="list-style-type: none"> "H/V-Keystone" p.49 "Auto V-Keystone" p.52 "H-Keystone Adjuster (EB-536Wi only)" p.51 When Quick Corner is selected: <ul style="list-style-type: none"> Select and correct the four corners of the projected image. <ul style="list-style-type: none"> "Quick Corner" p.49
Zoom	Adjusts the projected image size.
Control Panel Lock	<p>You can use this to restrict operation of the projector's control panel.</p> <ul style="list-style-type: none"> "Restricting Operation (Control Panel Lock)" p.100



Submenu	Function
Pointer Shape	<p>You can select the shape of the pointer.</p> <p>Pointer 1: </p> <p>Pointer 2: </p> <p>Pointer 3: </p> <p> "Pointer Function (Pointer)" p.91</p>
Volume	You can adjust the volume. Setting values are saved for each source.
Mic Input Level	<p>Adjusts the volume from the microphone. When the Mic Input Level is turned down to 0, no audio is output from the speaker.</p> <p>When the microphone input level is raised, the audio from the connected device becomes quieter. When the microphone input level is lowered, the audio from the connected device becomes louder.</p>
Remote Receiver	<p>You can limit the reception of the operation signal from the remote control.</p> <p>When set to Off, you cannot perform any operations from the remote control. If you want to make operations from the remote control, hold down the [Menu] button on the remote control for at least 15 seconds to reset the setting to its default value.</p>
User Button	<p>You can select the item in the Configuration menu to be assigned to the [User] button on the remote control. By pressing the [User] button the assigned menu item selection/adjustment screen is displayed, allowing you to make one-touch settings/adjustments. You can assign one of the following items to the [User] button.</p> <p>Power Consumption, Info, Progressive, Test Pattern, Resolution, Mic Input Level, Pattern Display, Auto Calibration (EB-536Wi only), Flip Horizontal</p>

Submenu	Function
Pattern	<p>Pattern Display: Display a pattern.</p> <p>Pattern Type: You can select from Patterns 1 to 5 or User Pattern. Patterns 1 to 4 display projection lines such as ruled lines or a grid. Pattern 5 displays a test pattern for 4:3 screens. When adjusting the focus for an image projected on a screen with an aspect ratio of 4:3 using EB-536Wi/EB-535W/EB-525W, select Pattern 5.</p> <p>Pattern 1:  Pattern 2: </p> <p>Pattern 3:  Pattern 4: </p> <p>Pattern 5: </p> <p>User Pattern: Captures a user pattern.  "Saving User Pattern" p.96</p> <p>Test Pattern: Displays a test pattern to adjust the projected status without connecting a device. While the test pattern is displayed, zoom, focus adjustments, and keystone correction can be performed. To cancel the test pattern, press the [Esc] button on the remote control or the control panel.</p> <p>When displaying a test pattern on a screen with an aspect ratio of 4:3 using EB-536Wi/EB-535W/EB-525W, set Pattern Type to Pattern 5, and then select Pattern Display.</p> <div style="border: 1px solid black; padding: 5px; margin-top: 10px;"> <p>Attention</p> <p>If a pattern is displayed for a long time, a residual image may be visible in projected images.</p> </div>

Submenu	Function
Reset	<p>You can reset all adjustment values in the Settings menu to their default settings, except for Zoom and User Button.</p> <p>See the following to return all menu items to their default settings.</p> <p> "Reset Menu" p.135</p>

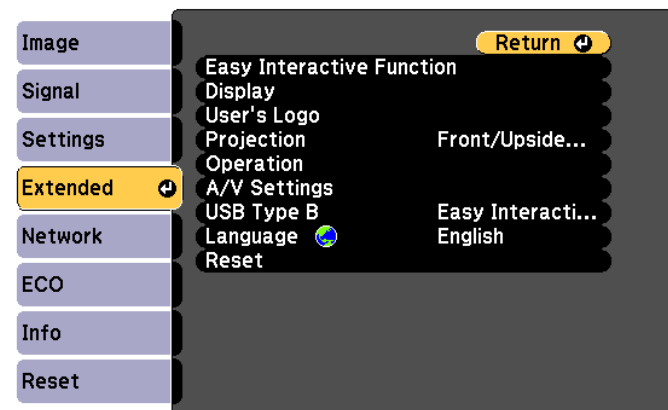
Extended Menu



Submenu	Function
Easy Interactive Function (EB-536Wi only)	<p>Allows you to use and set the interactive features.</p> <p> "Using the Interactive Features (EB-536Wi only)" p.58</p> <p>See the following table for more details.</p> <p> "Easy Interactive Function Setting Items (EB-536Wi only)" p.123</p>

Submenu	Function
Display	<p>You can make settings related to the projector's display.</p> <p>Messages: When set to Off, the following items will not be displayed.</p> <p>Item names when the Source, Color Mode, or Aspect Ratio is changed, messages when no signal is being input, and warnings such as High Temp Warning.</p> <p>Display Background*1: You can set the screen status for when no image signal is available to Black, Blue, or Logo.</p> <p>Startup Screen*1: Set to On to display the User's Logo when projection starts.</p> <p>A/V Mute*1: You can set the screen displayed when the remote control's [A/V Mute] button is pressed to Black, Blue, or Logo.</p> <p>Toolbars (EB-536Wi only): Set whether or not the drawing toolbar tab is always displayed when using the interactive features. The default is Hide for Set Time.</p> <p>Pen Mode Icon (EB-536Wi only): Set whether or not to always display the icon to change the pen mode when using the interactive features. The icon is hidden when set to Off.</p> <p>Projector Control (EB-536Wi only): Set the display position for the projector control toolbars when using the interactive features. The default value is Bottom. The icon is hidden when set to Off.</p>
User's Logo*1	<p>You can change the user's logo that is displayed as a background during Display Background, A/V Mute, and so on.</p> <p> "Saving a User's Logo" p.95</p>

Submenu	Function
Projection	<p>Select from one of the following projection methods depending on how the projector is installed.</p> <p>Front, Front/Ceiling, Rear, and Rear/Ceiling</p> <p>You can change the Projection mode as follows by pressing down the [A/V Mute] button on the remote control for about five seconds.</p> <p>Front↔Front/Ceiling</p> <p>Rear↔Rear/Ceiling</p> <p> "Installation Methods" p.23</p>
Operation	<p>Direct Power On: Set to On to turn on the projector simply by plugging it in.</p> <p>When the power cord is plugged in, note that the projector turns on automatically in cases such as a power outage being restored.</p> <p>High Altitude Mode: Set to On when using the projector above an altitude of 1500 m or higher.</p> <p>Startup Source Search: Set to Off to project images from the same source as the last time the projector was used.</p> <p>Auto Power On: (Only available when Standby Mode is set to Communication On.) If this is set to Computer1, the projector turns on when signals are received from the Computer1 port, even when the projector is in standby mode. The default value is Off.</p>

Submenu	Function
A/V Settings	<p>A/V Output: (Only available when Standby Mode is set to Communication On.)</p> <p>To perform the following functions when the projector is in standby, set to Always On.</p> <ul style="list-style-type: none"> • Outputting audio and images to external devices. • Outputting microphone audio from the projector's speaker. <div style="border: 1px solid black; padding: 5px; margin: 10px 0;">  Although the fan may rotate in standby mode, this is not an abnormality. </div> <p>Audio Output: Set the audio input port when projecting images from the Computer1, Computer2, S-Video, Video, and USB-A ports. When set to Audio1, Audio2, or Audio (L/R), audio is output from the selected port regardless of the source.</p> <p>HDMI Audio Output: Set the input audio when projecting images from the HDMI port. When set to Audio1, Audio2, or Audio (L/R), audio is output from the selected audio input port</p>

Submenu	Function
USB Type B (EB-536Wi only)	<p>Easy Interactive Function: Allows you to use the interactive features to operate computers (computer interactive mode). USB Display and Wireless Mouse functions are not available.</p> <p>USB Display/Easy Interactive Function: Allows you to use the interactive features to operate computers (computer interactive mode) and USB Display. The Wireless Mouse function is not available.</p> <p>Wireless Mouse/USB Display: Allows you to use the Wireless Mouse function and USB Display. You cannot use the interactive features to operate computers (computer interactive mode).</p> <ul style="list-style-type: none"> ☛ "Projecting with USB Display" p.45 ☛ "Controlling a Computer from the Projected Screen (Computer Interactive Mode)" p.62 ☛ "Using the Remote Control to Operate the Mouse Pointer (Wireless Mouse)" p.93
Language	Allows you to set the language for messages and menus.
Reset	<p>You can reset the adjustment values for Display^{*1}, Operation^{*2}, and A/V Settings^{*3} from the Extended menu to their default settings. See the following to return all menu items to their default settings.</p> <ul style="list-style-type: none"> ☛ "Reset Menu" p.135

*1 Except for **Toolbars**, **Pen Mode Icon**, and **Projector Control**. Except for **Display Background**, **Startup Screen**, and **User's Logo** when **User's Logo Protection** is set to **On**.

☛ "Managing Users (Password Protection)" [p.98](#)

*2 Except for **High Altitude Mode** and **Startup Source Search**.

*3 Except for **A/V Output**.

Easy Interactive Function Setting Items (EB-536Wi only)

General

Submenu	Function
Auto Calibration	Starts auto calibration.
Manual Calibration	Starts manual calibration.
Pen Mode	(This can only be set when projecting images from a computer.) Changes the function for the interactive pen. When set to PC Free Annotation (default), you can draw on the projected screen. When set to PC Interactive , you can operate a computer from the projected screen. You can change the interactive pen function with the [Pen Mode] button on the remote control, or the pen mode icon on the projected screen.
Hovering	When set to On (default), the pointer follows the pen tip as you hover it over the screen and move it around.

Submenu	Function
Advanced	<ul style="list-style-type: none"> • Distance of Projectors: When using multiple projectors in the same room, adjust the interactive pen operations according to the distance between the projectors. If interactive pen operations are unstable, try another mode. The standard distance set for Mode 1 is 2 m. • Sync of Projectors: When using multiple projectors in the same room, select the method for controlling the interactive pen interference. When set to Infrared (default), only infrared is used to synchronize. Set to Wired when connecting the projectors using cables.  "Connecting Multiple Projectors (EB-536Wi only)" p.38 • Wired Sync Mode: When set to Mode 1 (default), only cable connections are used to synchronize. When set to Mode 2, and Sync of Projectors is set to Wired, infrared synchronization is also performed at the same time. Set to Mode 2 when using in the same room as projectors that do not support cable connections. • Confirm Clear Screen: When set to On (default), a confirmation screen is displayed before clearing all of the content drawn on the projected screen. • Color Palette: When set to Palette 2, it changes to a color palette suitable for people who are color blind. Try Palette 2 if you find it hard to see the default color palette.

PC Interactive

Set when you want to operate a computer from the projected screen.

Submenu	Function
Pen Operation Mode	Set the operation mode and the number of users for the interactive pen. Two Users/Mouse (default)/One User/Mouse: Allows you to perform mouse operations using the interactive pen. One User/Pen: The pen input and Ink features are available in Windows 8.1, Windows 8, Windows 7, and Windows Vista.
Enable Right Click	(Only available when Pen Operation Mode is set to Two Users/Mouse or One User/Mouse .) When this is set to On , a long press of the pen tip acts as a right click.
Advanced	<ul style="list-style-type: none"> • Pen Tip Button: Allows you to set operations for the pen tip of the interactive pen. The default setting is Left Click. • Auto Adjust Pen Area: When this is set to On (default), the pen area is automatically adjusted as the resolution for the connected computer changes. Set to Off if you do not want to automatically adjust the pen area that has been manually adjusted. • Manual Adj. Pen Area: Adjusts the pen area manually.

Network Menu

When **Network Protection** is set to **On** in **Password Protection**, a message is displayed and the network settings cannot be changed. Set **Network Protection** to **Off** and then configure the network.

"Setting Password Protection" p.98

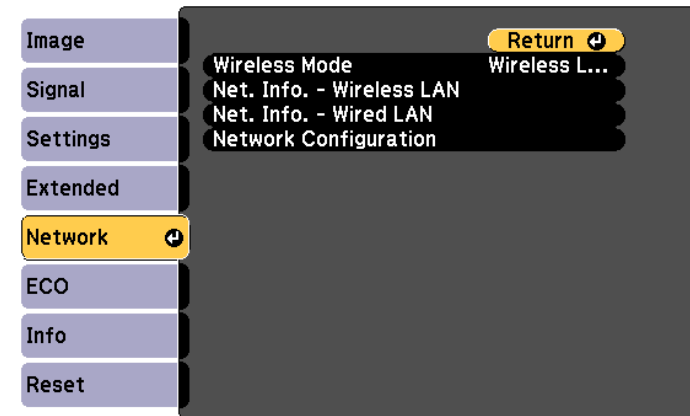

Submenu	Function
Wireless Mode	Set to Wireless LAN On when connecting the projector to the computer over wireless LAN. If you do not want to connect via wireless LAN, turn it Off to prevent unauthorized access by others. The default value is Wireless LAN On .
Net. Info. - Wireless LAN	Displays the following network setting status information. <ul style="list-style-type: none"> • Connection Mode • Wireless LAN Sys. • Antenna Level • Projector Name • SSID • DHCP • IP Address • Subnet Mask • Gateway Address • MAC Address • Region Code*

Submenu	Function
Net. Info. - Wired LAN	Displays the following network setting status information. <ul style="list-style-type: none"> • Projector Name • DHCP • IP Address • Subnet Mask • Gateway Address • MAC Address
Network Configuration	The following menus are available for setting Network items. Basic, Wireless LAN, Security, Wired LAN, Mail, Others, Reset, and Complete

* Displays available region information for the Wireless LAN unit being used. For more details, contact your local dealer or the nearest address provided in the Epson Projector Contact List.

 [Epson Projector Contact List](#)



- By using a Web browser of a computer connected to the projector on a network, you can set functions and control the projector. This function is called Web Control. You can easily enter text using a keyboard to make settings for Web Control such as Security settings.
 - "Changing Settings Using a Web Browser (Web Control)" p.102
- Contact your network administrator for details on network settings.

Notes on Operating the Network Menu

Selecting from the top menu and sub menus, and changing selected items is the same as making operations from the Configuration menu.

When done, make sure you go to the **Complete** menu, and select one of **Yes**, **No**, or **Cancel**. When you select **Yes** or **No**, you are returned to the Configuration menu.



Yes: Saves the settings and exits the Network menu.

No: Does not save the settings and exits the Network menu.

Cancel: Continues displaying the Network menu.

Soft Keyboard Operations

The Network menu contains items that require input of alphanumerics during setup. In this case, the following software keyboard is displayed. Use the [Left], [Right], [Up], and [Down] buttons on the remote control or the [Up], [Down], [Wide], and [Tele] buttons on the control panel to move the cursor to the key you want, and then press the [Enter] button to enter the alphanumerical character. Enter figures by holding down the [Num] button on the remote control, and pressing the numeric buttons. After inputting, press **Finish** on the keyboard to confirm your input. Press **Cancel** on the keyboard to cancel your input.

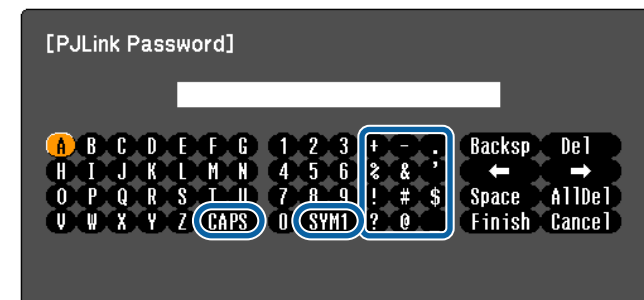

- Each time the **CAPS** key is selected and the [Enter] button is pressed, it switches between upper case and lower case.
- Each time the **SYM1/2** key is selected and the [Enter] button is pressed, it sets and changes the symbol keys for the section enclosed by the frame.

The following text can be entered.

Numbers	0123456789
Alphabet	ABCDEFGHIJKLMNOPQRSTUVWXYZ abcdefghijklmnopqrstuvwxyz
Symbols	! # \$ % & ' () + - . / < = > ? @ ^ _ ` { } ~



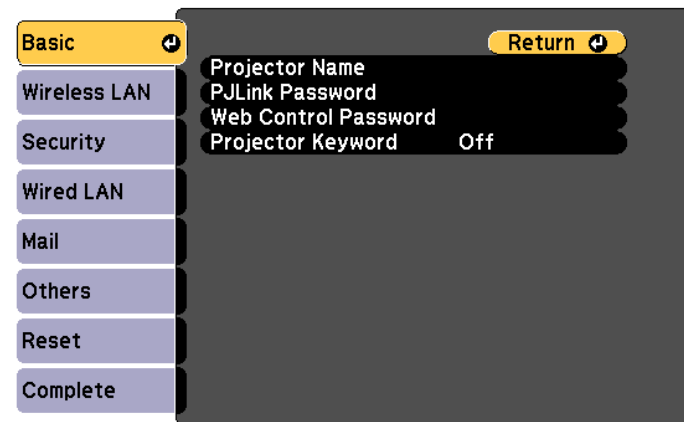

- Except for the **SSID**, colons (:) and spaces cannot be entered on the Network menu.
- Some symbols (" * , ; [\]) cannot be entered using the software keyboard. Use your Web browser to enter the text.
- ☛ "Changing Settings Using a Web Browser (Web Control)" [p.102](#)

Basic Menu





Submenu	Function
Projector Name	Displays the projector name used to identify the projector when connected to a network. When editing, you can enter up to 16 single-byte alphanumeric characters (The following symbols cannot be used: " * + , / ; < = > ? [` \]).
PJLink Password	Set a password to use when you access the projector using compatible PJLink software. You can enter up to 32 single-byte alphanumeric characters (symbols cannot be used).
Web Control Password	Set a password to use when making settings and controlling the projector using Web Control. You can enter up to eight single-byte alphanumeric characters (* cannot be used). The initial password is "admin". Web Control is a computer function that allows you to set up and control the projector by using the Web browser on a computer connected on a Network. ☛ "Changing Settings Using a Web Browser (Web Control)" p.102

Submenu	Function
Projector Key word	<p>When set to On, you have to enter the keyword when you try to connect the projector to a computer via a network. As a result, you can prevent presentations from being interrupted by connections from other computers. Normally this should be set to On.</p> <p> EasyMP Network Projection Operation Guide</p> <p> EasyMP Multi PC Projection Operation Guide</p>

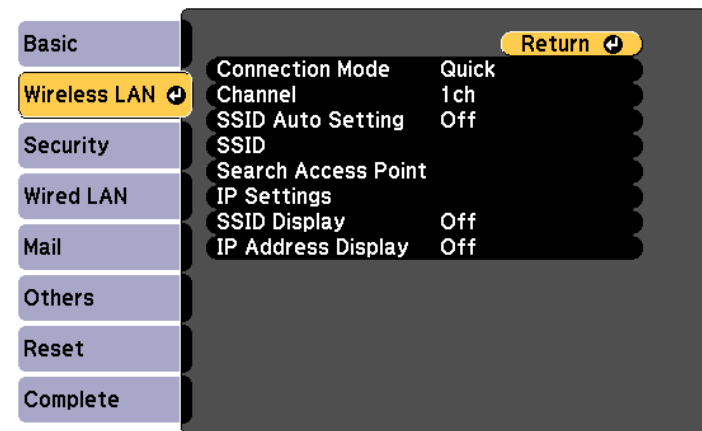
Wireless LAN Menu



Submenu	Function
Connection Mode	<p>Set the connection mode to use when connecting the projector and a computer via a wireless LAN.</p> <p>If you select Quick (default), a small network is created automatically by the projector and computer. Used in combination with EasyMP Network Projection. When SSID Auto Setting is set to On, the projector becomes an easy access point. When set to Off, the network is created in <u>Ad hoc mode</u>▶▶.</p> <p>If you select Advanced, the connection is established in <u>infrastructure mode</u>▶▶ through the access point installed. Set to Advanced when monitoring and controlling the projector over a network.</p> <p>See the following manual for details on Connection Mode.</p> <p> EasyMP Network Projection Operation Guide</p> <p> EasyMP Multi PC Projection Operation Guide</p>
Channel	<p>(This can only be set if Connection Mode is set to Quick.)</p> <p>Select the frequency band used by the wireless LAN from 1ch, 6ch, or 11ch.</p> <p>This is set to 11ch by default.</p>



Submenu	Function
SSID Auto Setting	(This can only be set if Connection Mode is set to Quick .) Set to On to speed up the projector search. Set to Off when connecting to multiple projectors at the same time. This is set to On by default.
SSID	(This item can only be set when SSID Auto Setting is set to Off .) Enter an SSID . When an SSID is provided for the wireless LAN system in which the projector participates, enter the SSID. You can enter up to 32 single-byte alphanumeric characters (^ can only be entered from the Web browser). If the SSID is left blank or set to ANY, an ANY connection (selects a connection from local access points without specifying an SSID) is established.
Search Access Point	When Connection Mode is set to Advanced , you can search for surrounding access points, and set the SSID to be connected from those access points. Depending on the access point settings, they may not be displayed in the list. You must set security separately.

Submenu	Function
IP Settings	(This item can only be set if Connection Mode is set to Advanced .) You can make network settings. DHCP : Set to On to make network settings using DHCP . If this is set to On , you cannot set any more addresses. IP Address : You can input the IP address assigned to the projector. You can enter a number from 0 to 255 in each field of the address. However, the following IP addresses cannot be used. 0.0.0.0, 127.x.x.x, 224.0.0.0 to 255.255.255.255 (where x is a number from 0 to 255) Subnet Mask : You can input the subnet mask for the projector. You can enter a number from 0 to 255 in each field of the address. However, the following subnet masks cannot be used. 0.0.0.0, 255.255.255.255 Gateway Address : You can input the IP address for the gateway for the projector. You can enter a number from 0 to 255 in each field of the address. However, the following Gateway addresses cannot be used. 0.0.0.0, 127.x.x.x, 224.0.0.0 to 255.255.255.255 (where x is a number from 0 to 255)
SSID Display	To prevent the SSID from being displayed on the LAN Standby screen, set this to Off .
IP Address Display	To prevent the IP address from being displayed on the LAN Standby screen, set this to Off .

Search Access Point screen

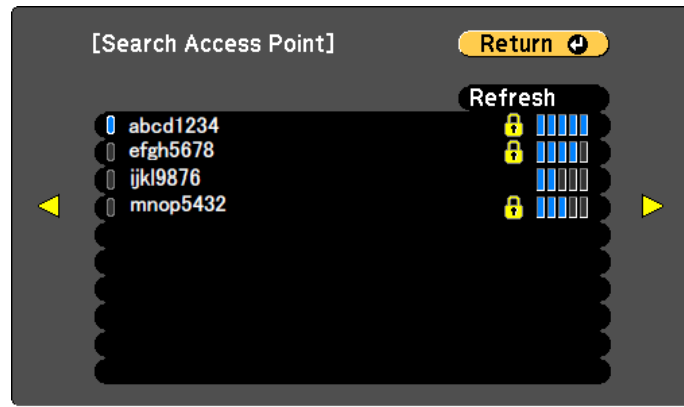
Detected access points are displayed in a list. The application can detect up to 30 access points.



Submenu	Function
Refresh	Searches for the access point again.
	Indicates an already set access point.
	Indicates the access points where security is set. If you select an access point where security has not been set, the Wireless LAN menu is displayed. If you select an access point where security has been set, the Security menu is displayed. Select a type of security according to the security settings for the access point.

Security Menu

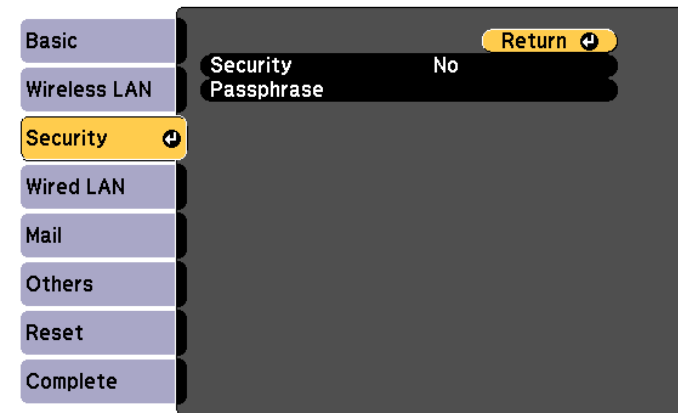

Submenu	Function
Security	Select the security type from the items that are displayed. When setting up Security, follow the instructions from the administrator of the network system you are about to access.
Passphrase	(This can only be selected when Security is set to WPA2-PSK or WPA/WPA2-PSK .) Enter the passphrase. You can enter at least 8 and up to 63 single-byte alphanumeric characters. When using with EasyMP Network Projection, you do not need to enter the passphrase in the computer if it is the initial (default) passphrase. ☛ "Reset Menu" p.133 You can enter up to 32 characters on the Configuration menu. When entering more than 32 characters, use your Web browser to enter the text. ☛ "Changing Settings Using a Web Browser (Web Control)" p.102 When Connection Mode is set to Quick , the initial passphrase is set.

Type of security

When the optional Wireless LAN unit is installed and being used in Advanced connection mode, it is strongly recommended that you set security.

WPA is an encryption standard that improves the security for wireless networks. The projector supports TKIP and AES encryption methods.

WPA also includes user authentication functions. WPA authentication provides two methods: using an authentication server, or authenticating between a computer and an access point without using a server. This projector supports the latter method, without a server.



For setting details, follow the instructions from your network administrator.

Wired LAN Menu

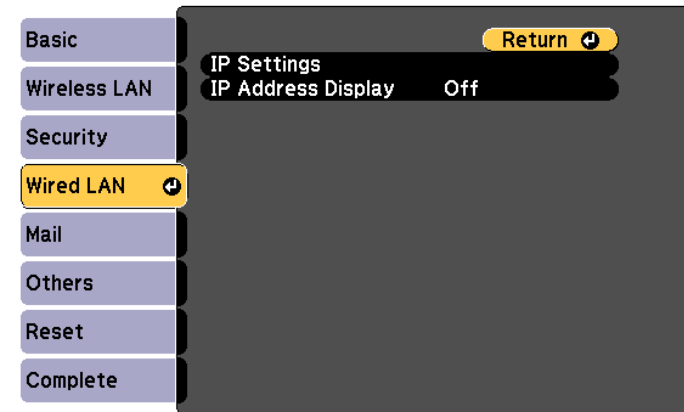

Submenu	Function
IP Settings	<p>You can make settings related to the following addresses.</p> <p>DHCP▶▶: Set to On to configure the network using DHCP. If this is set to On, you cannot set any more addresses.</p> <p>IP Address▶▶: You can input the IP address assigned to the projector. You can input a number from 0 to 255 in each field of the address. However, the following IP addresses cannot be used. 0.0.0.0, 127.x.x.x, 224.0.0.0 to 255.255.255.255 (where x is a number from 0 to 255)</p> <p>Subnet Mask▶▶: You can input the subnet mask for the projector. You can input a number from 0 to 255 in each field of the address. However, the following subnet masks cannot be used. 0.0.0.0, 255.255.255.255</p> <p>Gateway Address▶▶: You can input the IP address for the gateway for the projector. You can input a number from 0 to 255 in each field of the address. However, the following gateway addresses cannot be used. 0.0.0.0, 127.x.x.x, 224.0.0.0 to 255.255.255.255 (where x is a number from 0 to 255)</p>

Submenu	Function
IP Address Display	To prevent the IP address from being displayed on Network Info in the Network Menu and on the LAN Standby screen, set this to Off .

Mail Menu

When this is set, you receive an email notification if a problem or warning occurs in the projector.

☛ "Using the Mail Notification Function to Report Problems" [p.104](#)

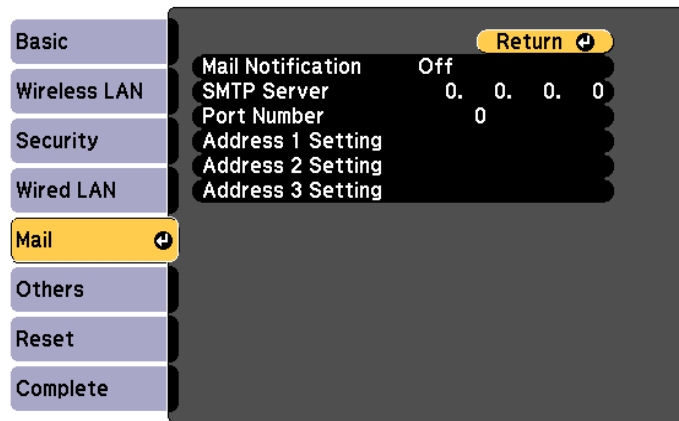

Submenu	Function
Mail Notification	Set to On to send an email to the preset addresses when a problem or warning occurs with a projector.
SMTP Server	You can input the <u>IP address</u> for the SMTP server for the projector. You can enter a number from 0 to 255 in each field of the address. However, the following IP addresses cannot be used. 127.x.x.x, 224.0.0.0 to 255.255.255.255 (where x is a number from 0 to 255)

Submenu	Function
Port Number	You can input the port number for the SMTP server. The default value is 25. You can input numbers between 1 to 65535.
Address 1 Setting/Address 2 Setting/Address 3 Setting	You can input the email address of the destination to send the notification email to. You can register up to three destinations. You can enter up to 32 single-byte alphanumeric characters for the email address. The following characters cannot be used: " () , ; < > [\] The address for destination 1 is the mail notification sender's address. You can select the problems or warnings to be notified about by email. When the selected problem or warning occurs in the projector, an email is sent to the specified destination address notifying that a problem or warning has occurred. You can select multiple items from the displayed items.

Others Menu

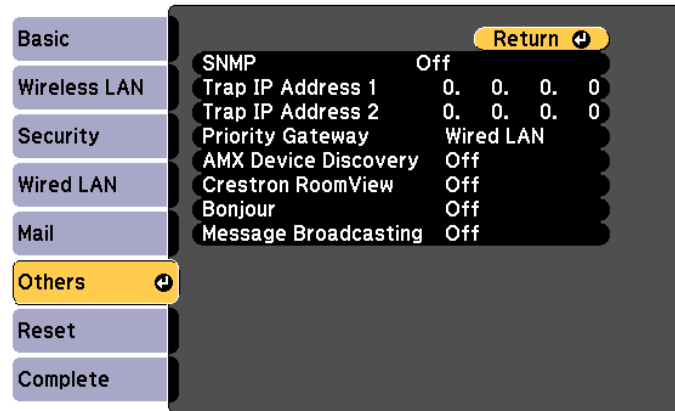

Submenu	Function
SNMP	Set to On to monitor the projector using SNMP. To monitor the projector, you need to install the SNMP manager program on your computer. SNMP should be managed by a network administrator. The default value is Off .
Trap IP Address 1/Trap IP Address 2	You can register up to two IP addresses for the SNMP trap notification destination. You can enter a number from 0 to 255 in each field of the address. However, the following IP addresses cannot be used. 127.x.x.x, 224.0.0.0 to 255.255.255.255 (where x is a number from 0 to 255)
Priority Gateway	You can set the priority gateway to a Wired LAN or Wireless LAN .
AMX Device Discovery	When the projector is connected to a network, set this to On to allow the projector to be detected by <u>AMX Device Discovery</u> . Set this to Off if you are not connected to an environment controlled by a controller from AMX or AMX Device Discovery.

Submenu	Function
Crestron Room View	Set this to On only when monitoring or controlling the projector over the network using Crestron RoomView®. Otherwise, set this to Off . ☛ "About Crestron RoomView®" p.108 When this is set to On , the following functions are not available. <ul style="list-style-type: none"> • Web Control • Message Broadcasting (EasyMP Monitor Plug-in)
Bonjour	Set this to On when connecting to the network using Bonjour. See Apple's Web site for more information on the Bonjour service. http://www.apple.com/
Message Broadcasting	You can switch the EPSON Message Broadcasting function to enable or disable.

Reset Menu

Resets all of the network settings.

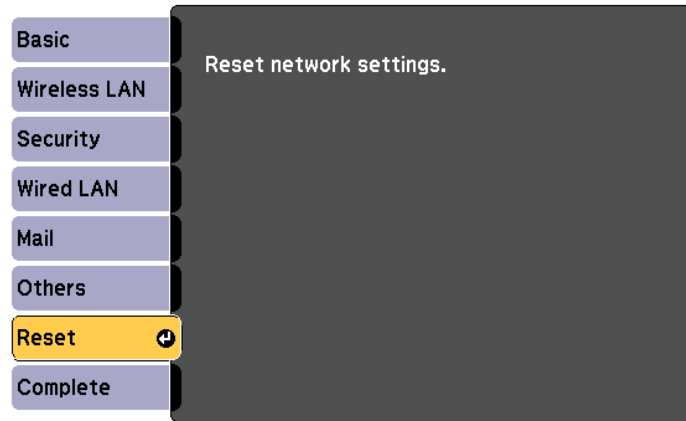



Submenu	Function
Reset network settings.	To reset all of the Network settings, select Yes .

ECO Menu

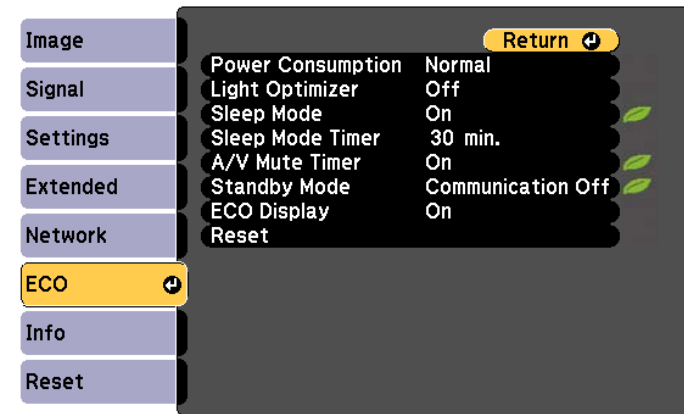
When you make ECO menu settings, the projector performs functions to save power. When power saving settings have been enabled, a leaf icon is displayed next to each submenu.



Submenu	Function
Power Consumption	You can set the lamp brightness to one of two settings. Select ECO if the images being projected are too bright, such as when projecting images in a dark room or onto a small screen. When ECO is selected, power consumption during projection decreases, and fan rotation noise is reduced.
Light Optimizer	(This item can only be set when Power Consumption is set to Normal and Auto Iris is set to Off .) When set to On , the lamp brightness is adjusted according to the image being projected. This helps to reduce the amount of electricity being used by lowering the lamp's brightness according to the scene being projected. The setting is stored for each Color Mode.

Submenu	Function
Sleep Mode	When set to On , this automatically stops projection when no image signal is being input and no operations are carried out for a specified length of time. Also, if no image signal is input for a specified length of time, the lamp dims until the power turns off. When an image signal is input, the projector returns to normal operating status.
Sleep Mode Timer	When Sleep Mode is set to On , you can set the time before the projector automatically turns off within a range of 1 to 30 minutes.
A/V Mute Timer	When set to On , this turns off the power automatically 30 minutes after A/V mute is enabled. Also, if A/V mute is enabled and a specified length of time has passed, the lamp dims until the power turns off. When A/V mute is disabled, the projector returns to normal operating status.
Standby Mode	<p>If you set Communication On, you can perform the following operations even if the projector is in standby mode.</p> <ul style="list-style-type: none"> • Monitor and control the projector from a computer over the network • Output audio and images to an external device (only when A/V Output is set to Always On) • Output audio from the projector's speaker (only when A/V Output is set to Always On) <div style="border: 1px solid black; padding: 5px; margin-top: 10px;">  Set Connection Mode to Advanced when monitoring and controlling the projector over wireless LAN.  Network - Wireless LAN - Connection Mode p.115 </div>
ECO Display	When set to On , when the lamp brightness changes from normal to low or low to normal, leaf icons are displayed at the bottom-left of the projected screen to indicate the power-saving status.

Submenu	Function
Reset	You can reset all adjustment values on the ECO menu to their default settings, except for Standby Mode . See the following to return all menu items to their default settings.  "Reset Menu" p.135

Info Menu (Display Only)

Lets you check the status of the image signals being projected and the status of the projector. Items that can be displayed vary depending on the source currently being projected. Depending on the model used, some input sources are not supported.

 "Automatically Detect Input Signals and Change the Projected Image (Source Search)" [p.43](#)

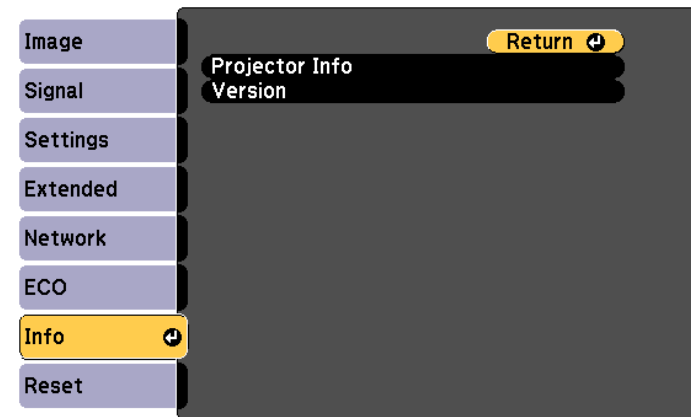

Submenu	Function
Projector Info	<ul style="list-style-type: none"> • Lamp Hours: Displays the cumulative lamp operating time*. When it reaches the lamp warning time, the characters are displayed in yellow. • Source: Displays the source name for the connected equipment currently being projected. • Input Signal: Displays the setting for Input Signal in the Signal menu according to the source. • Resolution: Displays the resolution. • Video Signal: Displays the settings for Video Signal in the Signal menu. • Refresh Rate: Displays the <u>refresh rate</u>▶▶. • Sync Info: Displays the image signal information. This information may be needed if service is required. • Status: Displays the information about errors that have occurred in the projector. This information may be needed if service is required. • Serial Number: Displays the projector's serial number. • Event ID: Displays the problems occurred in the projector using the Event IDs, when the projector and the computer are connected through the network. See the following page for the detailed information on the Event ID. 👉 "About Event ID" p.161
Version	Main/Video: Displays the projector's firmware version.

* The cumulative use time is displayed as "0H" for the first 10 hours. 10 hours and above is displayed as "10H", "11H", and so on.

Reset Menu

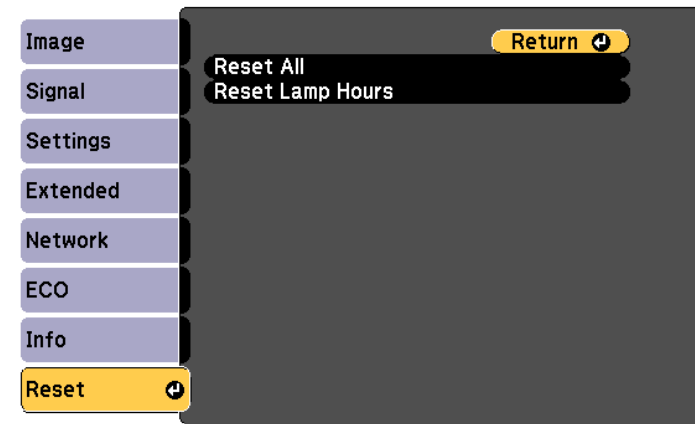

Submenu	Function
Reset All	You can reset all items in the Configuration menu to their default settings. The following items are not reset to their defaults: Input Signal , Zoom , User's Logo , all items for Network menus, Lamp Hours , Language , and Password .
Reset Lamp Hours	Clears the cumulative lamp hours use time. Reset when you replace the lamp.

Once the Configuration menu content has been set for one projector, you can use it to perform batch setup for multiple projectors (batch setup function). The batch setup function is only for projectors with the same model number.

Use one of the following methods.

- Setup using a USB memory.
- Setup by connecting the computer and projector with a USB cable.
- Setup using EasyMP Network Updater.

This guide explains the USB storage device and the USB cable methods.



The following content is not reflected by the batch setup function.

- Network menu settings (except for Mail and Others menu)
- Lamp Hours and Status from the Info menu
- Perform batch setup before adjusting the projected image. Adjustment values for the projected image, such as Keystone, are also reflected by the batch setup function. If batch setup is performed after adjusting the projected image, the adjustments you made may change.
- By using the batch setup function, the registered User's Logo is set for the other projectors. Do not register confidential information and so on as the User's Logo.



Caution

Performing batch setup is the customer's responsibility. If batch setup fails due to a power failure, communication error, and so on, the customer is responsible for any repair costs incurred.



- Use a FAT format USB storage device.
- The batch setup function cannot be used by USB storage device that incorporate security functions. Use a USB storage device that does not incorporate security functions.
- The batch setup function cannot be used by USB card readers or USB hard disks.

Saving Settings to a USB Memory

- 1** Disconnect the power cord from the projector, and check that all of the projector's indicators have turned off.
- 2** Connect the USB storage device to the projector's USB-A port.



- Connect the USB storage device to the projector. If the USB storage device is connected to the projector through a USB hub, the settings may not be saved correctly.
- Connect an empty USB storage device. If the USB storage device contains data other than the batch setup file, the settings may not be saved correctly.
- If you have saved a batch setup file from another projector to the USB storage device, delete the file or change the file name. The batch setup function cannot overwrite a batch setup file.
- The file name for the batch setup file is PJCONFDATA.bin. If you need to change the file name, add text after PJCONFDATA. If you change to another file name, the projector may not recognize it correctly.
- You can only use single-byte characters for the file name.

Setting Up Using a USB Memory

This section explains how to perform batch setup using a USB storage device.

- 3 While holding down the [Esc] button on the remote control or the control panel, connect the power cord to the projector.

The status indicator and the power indicator turn blue, and the lamp indicator and the temperature indicator turn orange.

When all of the projector's indicators turn on, release the [Esc] button.

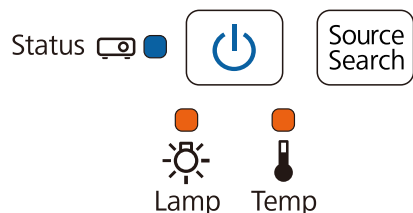

When all of the indicators start flashing, the batch setup file is being written.

Caution

- Do not disconnect the power cord from the projector while the file is being written. If the power cord is disconnected, the projector may not start correctly.
- Do not disconnect the USB storage device from the projector while the file is being written. If the USB storage device is disconnected, the projector may not start correctly.

When writing completes normally, the projector turns off, and only the power indicator is lit blue.

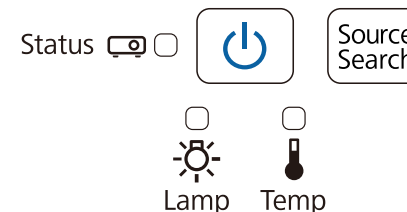

When the power turns off, remove the USB storage device.

Reflecting Saved Settings to Other Projectors

- 1 Disconnect the power cord from the projector, and check that all of the projector's indicators have turned off.
- 2 Connect the USB storage device containing the saved batch setup file to the projector's USB-A port.



- When the USB memory drive contains 1 to 3 types of batch setup files, the file is reflected to the projector with the same model number. If there are multiple files for a projector with the same model number, the settings may not be reflected correctly.
- When there are four or more types of batch setup files on the USB storage device, the settings may not be reflected correctly.
- Do not store any data except for the batch setup file on the USB storage device. If the USB storage device contains data other than the batch setup file, the settings may not be reflected correctly.

3 While holding down the [Menu] button on the remote control or the control panel, connect the power cord to the projector.

The status indicator and the power indicator turn blue, and the lamp indicator and the temperature indicator turn orange.

When all of the projector's indicators turn on, release the [Menu] button. The indicators turn on for approximately 75 seconds.

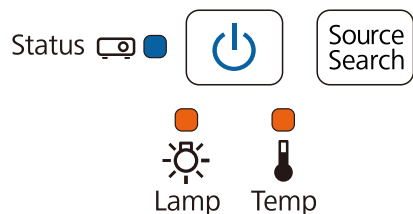

When all of the indicators start flashing, the settings are being written.

Caution

- Do not disconnect the power cord from the projector while the settings are being written. If the power cord is disconnected, the projector may not start correctly.
- Do not disconnect the USB storage device from the projector while the settings are being written. If the USB storage device is disconnected, the projector may not start correctly.

When writing completes normally, the projector turns off, and only the power indicator is lit blue.

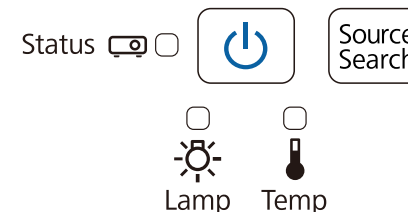

When the projector turns off, disconnect the USB storage device.

Setup by Connecting the Computer and Projector with a USB Cable



The following operating systems support the batch setup function.

- Windows Vista and later
- Mac OS X 10.5.3 and later

Saving Settings to a Computer

- 1** Disconnect the power cord from the projector, and check that all of the projector's indicators have turned off.
- 2** Connect the computer's USB port to the projector's USB-B port with a USB cable.

- 3 While holding down the [Esc] button on the remote control or the control panel, connect the power cord to the projector.

The status indicator and the power indicator turn blue, and the lamp indicator and the temperature indicator turn orange.

When all of the projector's indicators turn on, release the [Esc] button.

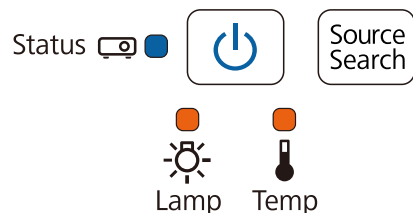

The projector is recognized as a removable disk by the computer.

- 4 Open the removable disk, and save the batch setup file (PJCONFDATA.bin) to the computer.



If you need to change the name of the batch setup file, add text after PJCONFDATA. If you change the PJCONFDATA section of the file name, the projector may not be able to recognize the file correctly. You can only use single-byte characters for the file name.

- 5 Perform "**Remove USB Device**" on the computer, and then disconnect the USB cable.



When using OS X, perform "**Remove EPSON_PJ**".

The projector turns off and only the power indicator is lit blue.

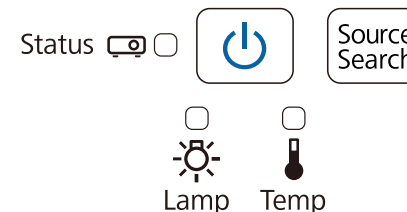

Reflecting Saved Settings to Other Projectors

- 1 Disconnect the power cord from the projector, and check that all of the projector's indicators have turned off.
- 2 Connect the computer's USB port to the projector's USB-B port with a USB cable.
- 3 While holding down the [Menu] button on the remote control or the control panel, connect the power cord to the projector.

The status indicator and the power indicator turn blue, and the lamp indicator and the temperature indicator turn orange.

When all of the projector's indicators turn on, release the [Menu] button.

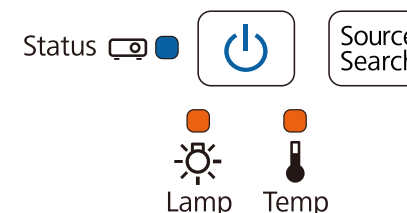

The projector is recognized as a removable disk by the computer.

- Copy the batch setup file (PJCONFDATA.bin) that you saved to your computer to the toplevel folder of the removable disk.

 Do not copy any files or folders other than the batch setup file to the removable disk.

- Perform **"Remove USB Device"** on your computer, and then disconnect the USB cable.

 When using OS X, perform **"Remove EPSON_PJ"**.

When all of the indicators start flashing, the settings are being written.

Caution

Do not disconnect the power cord from the projector while the settings are being written. If the power cord is disconnected, the projector may not start correctly.

When writing completes normally, the projector turns off, and only the power indicator is lit blue.

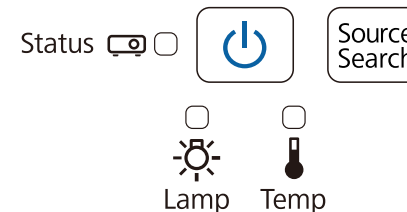

When Setup Fails

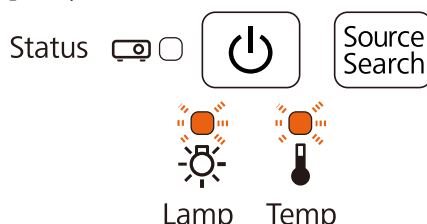
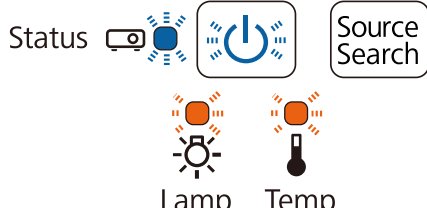
Check	Remedy
<p>Are the lamp indicator and the temperature indicator flashing orange quickly?</p> 	<p>The batch setup file may be corrupt, or the USB storage device or USB cable may not be connected correctly. Disconnect the USB storage device or USB cable, unplug and then plug in the projector's power cord, and then try again.</p>
<p>Are the power indicator and the status indicator flashing blue quickly, and the lamp indicator and the temperature indicator flashing orange quickly?</p> 	<p>Writing the settings may have failed and an error may have occurred in the projector's firmware. Stop using the projector, remove the power plug from the electrical outlet, and contact your local dealer or the nearest address provided in the Epson Projector Contact List.</p>



Troubleshooting

This chapter explains how to identify problems and what to do if a problem is found.

If a problem occurs with the projector, the Help screen is displayed to assist you by pressing the Help button. You can solve problems by answering the questions.

- 1 Press the [Help] button.
The Help screen is displayed.

Using the remote control

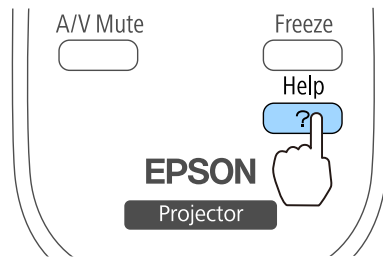

Using the control panel

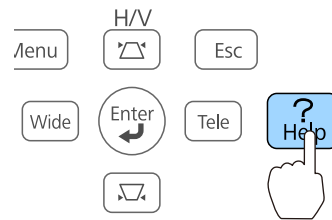

- 2 Select a menu item.

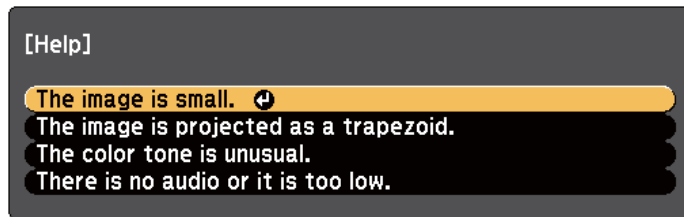

Using the remote control

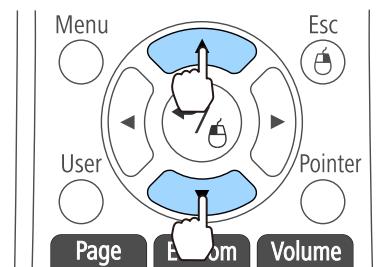

Using the control panel

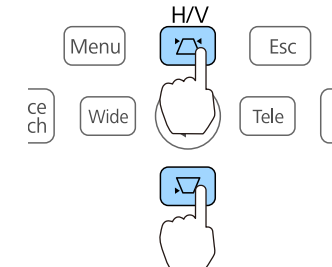

- 3 Confirm the selection.

Using the remote control

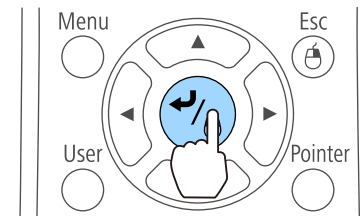

Using the control panel

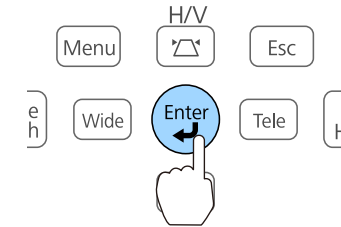

Questions and solutions are displayed as shown on the screen below. Press the [Help] button to exit the Help.

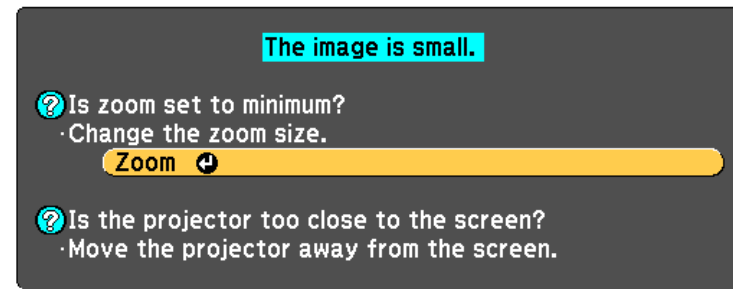

See the following if the Help function does not provide a solution to the problem.

☛ "Problem Solving" p.143

If you are having a problem with the projector, first check the projector's indicators and see "Reading the Indicators".

See the following if the indicators do not show clearly what the problem might be.

☛ "When the Indicators Provide No Help" [p.147](#)



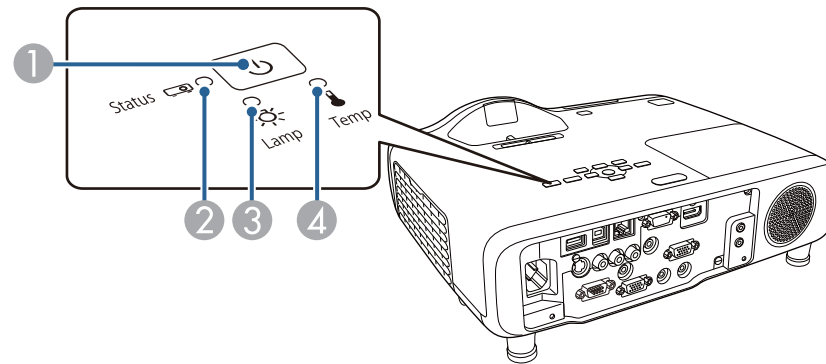

Reading the Indicators

The projector is provided with the following four indicators that indicate the operating status of the projector.



- ① Power indicator Indicates the projector's status.
- ② Status indicator Indicates the projector's status.
- ③ Lamp indicator Indicates the lamp's status.
- ④ Temp indicator Indicates the internal temperature's status.













Indicators		Status	Explanation
Power supply	Status		
 Blue - Lit	<input type="checkbox"/> Off	Standby condition	Power is being supplied to the projector. When the [⏻] power button is pressed in this condition, projection starts.
		Network monitoring status	The projector is being monitored and controlled over a network (when Standby Mode is set to Communication On). If the power cord is disconnected and then reconnected in this status, the power indicator flashes blue.

























Indicators		Status	Explanation
Power supply	Status		
 Blue - Lit	 Blue - Flashing	Warm-up status	This is the status immediately after turning on the projector. Warm-up takes approximately 30 seconds after the lamp turns on. In this status you cannot turn off the projector, even if you press the [⏻] power button.
		Cool down status	This is the status immediately after turning off the projector. In this status, all buttons are disabled.
 Blue - Lit	 Blue - Lit	Normal status	The projector is projecting.



Refer to the following table to see what the indicators mean and how to remedy problems that they indicate.

If all indicators are off, check that the power cord is connected correctly and that the power is being supplied normally.



Sometimes, when the power cord is unplugged, the [⏻] power indicator remains lit for a short period, but this is not a fault.

Indicators				Cause	Remedy or Status
Power supply	Status	Lamp	Temperature		
 Off	 Blue - Flashing	 Orange - Flashing	<input type="checkbox"/> Off	Internal Error	Stop using the projector, remove the power plug from the electrical outlet, and contact your local dealer or the nearest address provided in the Epson Projector Contact List.  Epson Projector Contact List
 Off	 Blue - Flashing	<input type="checkbox"/> Off	 Orange - Flashing	Fan Error Sensor Error	Stop using the projector, remove the power plug from the electrical outlet, and contact your local dealer or the nearest address provided in the Epson Projector Contact List.  Epson Projector Contact List
 Off	 Blue - Flashing	<input type="checkbox"/> Off	 Orange - Lit	High Temp Error Overheating	The lamp turns off automatically and projection stops. Wait for about five minutes. After about five minutes the projector switches to standby mode, so check the following two points. <ul style="list-style-type: none"> • Check that the air filter and air exhaust vent are clear, and that the projector is not positioned against a wall. • If the air filter is clogged, clean or replace it.  "Cleaning the Air Filter" p.163, "Replacing the Air Filter" p.169 If the error continues after checking the points above, stop using the projector, remove the power plug from the electrical outlet, and contact your local dealer or the nearest address provided in the Epson Projector Contact List.  Epson Projector Contact List

Indicators				Cause	Remedy or Status
Power supply	Status	Lamp	Temperature		
					When using at an altitude of 1500 m or more, set High Altitude Mode to On .  "Extended Menu" p.120
 Off	 Blue - Flashing	 Orange - Lit	 Off	Lamp Error Lamp Failure	Check the following two points. <ul style="list-style-type: none"> • Take out the lamp and check if it is cracked. • Clean the air filter.  "Replacing the Lamp" p.166  "Cleaning the Air Filter" p.163
					If the lamp is not cracked: Reinstall the lamp and plug in the power cord. If the error continues: Stop using the projector, remove the power plug from the electrical outlet, and contact your local dealer or the nearest address provided in the Epson Projector Contact List.  Epson Projector Contact List
					If the lamp is cracked: Contact your local dealer or the nearest address provided in the Epson Projector Contact List. (Images cannot be projected until the lamp is replaced.)  Epson Projector Contact List
					When using at an altitude of 1500 m or more, set High Altitude Mode to On .  "Extended Menu" p.120
 Off	 Blue - Flashing	 Orange - Flashing	 Orange - Flashing	Auto Iris Error	Stop using the projector, remove the power plug from the electrical outlet, and contact your local dealer or the nearest address provided in the Epson Projector Contact List.  Epson Projector Contact List
 Off	 Blue - Flashing	 Orange - Lit	 Orange - Lit	Power Err.	
 Blue - Flashing	 State dependent indication	 State dependent indication	 Orange - Flashing	High Temp Warning	(This is not an abnormality. However, if the temperature rises too high again, projection stops automatically.) <ul style="list-style-type: none"> • Check that the air filter and air exhaust vent are clear, and that the projector is not positioned against a wall. • If the air filter is clogged, clean or replace it.  "Cleaning the Air Filter" p.163 , "Replacing the Air Filter" p.169

Indicators				Cause	Remedy or Status
Power supply	Status	Lamp	Temperature		
 Blue - Flashing	<input type="checkbox"/> State dependent indication	 Orange - Flashing	<input type="checkbox"/> State dependent indication	Replace Lamp	Replace it with a new lamp.  "Replacing the Lamp" p.166 If you continue to use the lamp after the replacement period has passed, the possibility that the lamp may explode increases. Replace it with a new lamp as soon as possible.













- See the following if the projector is not operating properly, even though the indicators are all showing normal.
 -  "When the Indicators Provide No Help" [p.147](#)
- If the indicators are in a state not shown in this table, stop using the projector, remove the power plug from the electrical outlet, and contact your local dealer or the nearest address provided in the Epson Projector Contact List.
 -  [Epson Projector Contact List](#)

When the Indicators Provide No Help

If any of the following problems occur and the indicators do not offer a solution, refer to the pages given for each problem.







Problems Relating to Images

<ul style="list-style-type: none"> • No images appear Projection does not start, the projection area is completely black or blue. 	 p.148
<ul style="list-style-type: none"> • Moving images are not displayed (only the moving image portion turns black) Moving images played back from a computer appear black and the images are not projected 	 p.149
<ul style="list-style-type: none"> • Projection stops automatically 	 p.149
<ul style="list-style-type: none"> • The message "Not supported" is displayed 	 p.149
<ul style="list-style-type: none"> • The message "No Signal" is displayed 	 p.150
<ul style="list-style-type: none"> • Images are fuzzy, out of focus, or distorted 	 p.150
<ul style="list-style-type: none"> • Interference or distortion appear in images 	 p.151
<ul style="list-style-type: none"> • The mouse cursor flickers (only when projecting USB display) 	 p.152
<ul style="list-style-type: none"> • The image is truncated (large) or small, or the aspect ratio is not suitable Only part of the image is displayed, or the height and width ratios of the image are not correct 	 p.152
<ul style="list-style-type: none"> • Image colors are not right The whole image appears purplish or greenish, images are black & white, or colors appear dull 	 p.153
<ul style="list-style-type: none"> • Images appear dark 	 p.153







Problems when Projection Starts

<ul style="list-style-type: none"> • The projector does not turn on 	 p.154
---	---

Other Problems

<ul style="list-style-type: none"> • No sound can be heard or the sound is faint 	 p.154
<ul style="list-style-type: none"> • No sound can be heard from the microphone 	 p.155
<ul style="list-style-type: none"> • There is noise in the audio (only when projecting USB display) 	 p.155
<ul style="list-style-type: none"> • The remote control does not work 	 p.156
<ul style="list-style-type: none"> • I want to change the language for messages and menus 	 p.156
<ul style="list-style-type: none"> • Mail is not received even if a problem occurs in the projector 	 p.156
<ul style="list-style-type: none"> • Cannot change settings using a web browser 	 p.157

Problems with the Interactive Function (EB-536Wi only)

<ul style="list-style-type: none"> • Cannot draw on the projected screen 	 p.157
<ul style="list-style-type: none"> • Cannot operate a computer from the projected screen after connecting to the computer 	 p.158
<ul style="list-style-type: none"> • The message "An error occurred in the Easy Interactive Function." is displayed 	 p.158
<ul style="list-style-type: none"> • Computer's mouse does not work correctly 	 p.158
<ul style="list-style-type: none"> • The interactive pen does not work 	 p.159
<ul style="list-style-type: none"> • The response time for the interactive pen is slow (only when projecting USB display) 	 p.159
<ul style="list-style-type: none"> • The dot moves automatically or does not move to the next position during manual calibration 	 p.160

Problems Relating to Images

No Images Appear

Check	Remedy
Did you press the [⏻] power button?	Press the [⏻] power button to turn the power on.
Are the indicators switched off?	The power cord is not connected correctly or power is not being supplied. Connect the projector's power cord correctly. 🖱️ "Turning On the Projector" p.41 Check that your electrical outlet or power source is functioning correctly.
Is A/V Mute active?	Press the [A/V Mute] button to cancel A/V Mute. 🖱️ "Hiding the Image and Sound Temporarily (A/V Mute)" p.90
Are the Configuration menu settings correct?	Reset all of the settings. 🖱️ Reset - Reset All p.135
Is the image to be projected completely black? (Only when projecting computer images)	Some input images, such as screen savers, may be completely black.
Is the image signal format setting correct? (Only when projecting images from a video source)	Change the setting according to the signal for the connected equipment. 🖱️ Signal - Video Signal p.117
Is the USB cable connected correctly? (Only when projecting USB Display)	Check that the USB cable is connected correctly. Reconnect it if it is not connected or not connected properly.
Is Windows Media Center displayed in full screen? (Only when projecting using USB Display or network connection)	When Windows Media Center is displayed at full screen, you cannot project using USB Display or network connection. Reduce the screen size.
Is an application using the Windows DirectX function displayed? (Only when projecting using USB Display or network connection)	Applications using the Windows DirectX function may not display images correctly.

Moving Images are Not Displayed (Only the Moving Image Portion Turns Black)

Check	Remedy
Is the computer's image signal being output to the LCD and the monitor? (Only when projecting images from a laptop computer or a computer with a built-in LCD screen)	Change the image signal from the computer to external output only. Check your computer's documentation, or contact the computer's manufacturer.
Are the contents of the moving image you are trying to project copyright protected?	The projector may not be able to project copyright protected moving images that are being played back on a computer. For more details, see the user's guide supplied with the player.

Projection Stops Automatically

Check	Remedy
Are Sleep Mode or A/V Mute Timer set to On ?	If any of these are set to On , the power turns off automatically in the following situations. <ul style="list-style-type: none"> • When Sleep Mode is set to On: If no operations are performed for a specified length of time while no image signal is being input. • When A/V Mute Timer is set to On: If approximately 30 minutes has passed since the A/V mute was enabled. To prevent the projector from switching off automatically, make sure each setting is set to Off. ☛ ECO - Sleep Mode, A/V Mute Timer p.133
Is the computer in power-saving mode?	If the computer is in power-saving mode and no operations are performed for a specified period of time, the image may disappear. Perform an operation on the computer to display the image again.

The Message "Not supported" is Displayed

Check	Remedy
Is the image signal format setting correct? (Only when projecting images from a video source)	Change the setting according to the signal for the connected equipment. ☛ Signal - Video Signal p.117
Do the image signal resolution and the refresh rate correspond to the mode? (Only when projecting computer images)	See the documentation supplied with the computer for how to change the image signal resolution and refresh rate output from the computer. ☛ "Supported Monitor Displays" p.176

The Message "No Signal" is Displayed

Check	Remedy
Are the cables connected correctly?	Check that all the cables required for projection are securely connected. ☛ "Turning On the Projector" p.41
Is the correct port selected?	Change the image by pressing the [Source Search] button on the remote control or the control panel. ☛ "Automatically Detect Input Signals and Change the Projected Image (Source Search)" p.43
Is the power of the connected computer or video equipment turned on?	Turn the power on for the equipment.
Are the image signals being output to the projector? (Only when projecting images from a laptop computer or a computer with a built-in LCD screen)	If the image signals are only being output to the computer's LCD monitor or accessory monitor, change the output so that the image signals are also output externally. For some computer models, when the image signals are output externally, they no longer appear on the LCD monitor or accessory monitor. If the connection is made while the power of the projector or computer is already turned on, the Fn key (Function key) that changes the computer's image signal to external output may not work. Turn the projector and computer off and then back on again. ☛ "Turning On the Projector" p.41 ☛ Computer's documentation
Is the computer in power-saving mode?	If the computer is in power-saving mode and no operations are performed for a specified period of time, the image may disappear. Perform an operation on the computer to display the image again.

Images are Fuzzy, Out of Focus, or Distorted

Check	Remedy
Is the focus adjusted correctly?	Move the focus lever to adjust the focus. ☛ "Correcting the Focus" p.53
Is the projector at the correct distance?	Is it projecting outside of the recommended projection distance range? Setup within the recommended range. ☛ "Screen Size and Projection Distance" p.173
Is the Keystone adjustment value too large?	Lower the projection angle to reduce the amount of Keystone correction. ☛ "Adjusting the Image Position" p.52

Check	Remedy
Is the <u>Aspect Ratio</u> set correctly?	You can change the Aspect Ratio of the projected image to suit the type, the ratio of height and width, and the resolution of the input signals. ☛ "Changing the Aspect Ratio of the Projected Image" p.55
Has condensation formed on the lens?	If the projector is suddenly taken from a cold environment to a warm environment, or if sudden ambient temperature changes occur, condensation may form on the surface of the lens, and this may cause the images to appear fuzzy. Set the projector up in the room about one hour before it is used. If condensation forms on the lens, turn the projector off and wait for the condensation to disappear.

Interference or Distortion Appear in Images

Check	Remedy
Is the image signal format setting correct? (Only when projecting images from a video source)	Change the setting according to the signal for the connected equipment. ☛ Signal - Video Signal p.117
Are the cables connected correctly?	Check that all the cables required for projection are securely connected. ☛ "Connecting Equipment" p.26
Is an extension cable being used?	If an extension cable is used, electrical interference may affect the signals. Use the cables supplied with the projector to check if the cables you are using may be causing the problem.
Is the correct resolution selected? (Only when projecting computer images)	Set the computer so that the signals being output are compatible with the projector. ☛ "Supported Monitor Displays" p.176 ☛ Computer's documentation
Are the <u>Sync</u> and <u>Tracking</u> settings adjusted correctly? (Only when projecting computer images)	Press the [Auto] button on the remote control or the [Enter] button on the control panel to perform automatic adjustment. If the images are not adjusted correctly even after performing automatic adjustment, you can also make adjustments from the Configuration menu. ☛ Signal - Tracking, Sync. p.117
Is Transfer layered window selected? (Only when projecting USB Display)	Click All Programs - EPSON Projector - Epson USB Display - Epson USB Display Ver.x.xx Settings , and then clear the Transfer layered window checkbox.

The Mouse Cursor Flickers (Only when Projecting USB Display)

Check	Remedy
Is Make the movement of the mouse pointer smooth. selected?	Click All Programs - EPSON Projector - Epson USB Display - Epson USB Display Ver.x.xx Settings , and then select the Make the movement of the mouse pointer smooth. checkbox. (Windows 2000 is unavailable.) Windows Aero becomes unavailable if this is selected in Windows 7 and Windows Vista.

The Image Is Truncated (Large) or Small, or the Aspect Is Not Suitable

Check	Remedy
Is a wide-panel computer image being projected? (Only when projecting computer images)	Change the setting according to the signal for the connected equipment. ☛ Signal - Resolution p.117
Is the image still being enlarged by E-Zoom?	Press the [Esc] button on the remote control to cancel E-Zoom. ☛ "Enlarging Part of the Image (E-Zoom)" p.92
Is the display position adjusted correctly?	(Only when projecting analog RGB signals input from the Computer1 or Computer2 port) Press the [Auto] button on the remote control or the [Enter] button on the control panel to adjust the position. You can also adjust the position from the Configuration menu. ☛ Signal - Position p.117
Is the computer set for dual display? (Only when projecting computer images)	If dual display is activated in the Display Properties of the computer's Control Panel, only about half of the image on the computer screen is projected. To display the entire image on the computer screen, turn off the dual display setting. ☛ Computer video driver documentation
Is the correct resolution selected? (Only when projecting computer images)	Set the computer so that the signals being output are compatible with the projector. ☛ "Supported Monitor Displays" p.176 ☛ Computer's documentation
Is the projection mode correct?	Depending on how the projector is installed, set Projection to one of the following: Front, Front/Ceiling, Rear, Rear/Ceiling. ☛ Extended - Projection p.120 ☛ "Installation Methods" p.23

Image Colors are Not Right

Check	Remedy
Do the input signal settings match the signals from the connected device?	Change the following settings according to the signal for the connected equipment. <ul style="list-style-type: none"> • When the image is from a device connected to the Computer1 or Computer2 port. <ul style="list-style-type: none"> ☛ Signal - Input Signal p.117 • When the image is from a device connected to the Video or S-Video port. <ul style="list-style-type: none"> ☛ Signal - Video Signal p.117
Is the image brightness adjusted correctly?	Adjust the Brightness setting from the Configuration menu. <ul style="list-style-type: none"> ☛ Image - Brightness p.116
Are the cables connected correctly?	Check that all the cables required for projection are securely connected. <ul style="list-style-type: none"> ☛ "Connecting Equipment" p.26
Is the <u>contrast</u>  adjusted correctly?	Adjust the Contrast setting from the Configuration menu. <ul style="list-style-type: none"> ☛ Image - Contrast p.116
Is color adjustment set to an appropriate value?	Adjust the Color Adjustment setting from the Configuration menu. <ul style="list-style-type: none"> ☛ Image - Color Adjustment p.116
Are the color saturation and tint adjusted correctly? (Only when projecting images from a video source)	Adjust the Color Saturation and Tint settings from the Configuration menu. <ul style="list-style-type: none"> ☛ Image - Color Saturation, Tint p.116

Images Appear Dark

Check	Remedy
Is the image brightness set correctly?	Adjust the Brightness and Power Consumption settings from the Configuration menu. <ul style="list-style-type: none"> ☛ Image - Brightness p.116 ☛ ECO - Power Consumption p.133
Is the <u>contrast</u>  adjusted correctly?	Adjust the Contrast setting from the Configuration menu. <ul style="list-style-type: none"> ☛ Image - Contrast p.116
Is it time to replace the lamp?	When the lamp is nearly ready for replacement, the images become darker and the color quality declines. Replace the lamp with a new one. <ul style="list-style-type: none"> ☛ "Replacing the Lamp" p.166
Are you using the projector at a high altitude or in a location subject to high temperatures?	The screen may become dark when using at high altitude or in a location subject to high temperatures. Although you cannot make Power Consumption settings at this time, you can continue to use the projector.

Problems when Projection Starts

The Projector Does Not Turn On

Check	Remedy
Did you press the [⏻] power button?	Press the [⏻] power button to turn the power on.
Are the indicators switched off?	The power cord is not connected correctly or power is not being supplied. Disconnect and then reconnect the power cord. ☛ "Turning On the Projector" p.41 Check that your electrical outlet or power source is functioning correctly.
Do the indicators turn on and off when the power cord is touched?	There is probably a poor contact in the power cord, or the power cord may be defective. Reinsert the power cord. If this does not solve the problem, stop using the projector, disconnect the power cord from the electrical outlet, and contact your local dealer or the nearest address provided in the Epson Projector Contact List. ☛ Epson Projector Contact List
Is the Control Panel Lock set to Full Lock ?	Press the [⏻] power button on the remote control. If you do not want to use Control Panel Lock , change the setting to Off . ☛ Settings - Control Panel Lock p.119
Is remote control operation restricted?	Check the Remote Receiver from the Configuration menu. ☛ Settings - Remote Receiver p.119

Other Problems

No Sound can be Heard or the Sound is Faint

Check	Remedy
Check that the audio/video cable is securely attached to both the projector and audio source.	Disconnect the cable from the audio input port, and then reconnect the cable.
Is the projector volume set to the minimum?	Adjust the volume so that sound can be heard. ☛ Settings - Volume p.119 ☛ "Adjusting the Volume" p.53

Check	Remedy
Is the volume for the computer or from the image source set to the minimum?	Adjust the volume so that sound can be heard.
Is the Mic Input Level set at the maximum?	Lower the Mic Input Level. ☛ Settings - Mic Input Level p.119
Is A/V Mute active?	Press the [A/V Mute] button to cancel A/V Mute. ☛ "Hiding the Image and Sound Temporarily (A/V Mute)" p.90
Is the audio cable's specification "No resistance"?	When using a commercially available audio cable, make sure it is labeled "No resistance".
Is it connected with an HDMI cable?	If no audio is output when connecting via an HDMI cable, set the connected equipment to PCM output.
Is Output audio from the projector selected? (Only when projecting USB Display)	Click All Programs - EPSON Projector - Epson USB Display - Epson USB Display Ver.x.xx Settings , and then select the Output audio from the projector checkbox.
Is the correct audio input selected?	Check the Audio Output and HDMI Audio Output settings from the Configuration menu. ☛ Extended - A/V Settings p.120

No Sound can be Heard from the Microphone

Check	Remedy
Is the microphone connected correctly?	Disconnect the cable from the Microphone (Mic) input port, and then reconnect the cable. ☛ "Connecting a Microphone" p.32
Is the microphone input volume turned down too low?	Adjust the microphone input volume so that sound can be heard. ☛ Settings - Mic Input Level p.119
Are you using a plug-in power type microphone?	The projector does not support plug-in power type microphones. Use a commercially available dynamic microphone.

There is Noise in the Audio (Only when Projecting USB Display)

Check	Remedy
Is the volume for the computer set to the minimum while the projector is set to the maximum?	The audio may contain noise if the volume for the computer is set to minimum while the projector's volume is set to maximum. Increase the volume for the computer, and decrease the volume for the projector. ☛ Settings - Volume p.119

The Remote Control Does Not Work

Check	Remedy
Is the remote control light-emitting area pointing towards the remote receiver on the projector during operation?	Point the remote control towards the remote receiver during operation. ☛ "Remote Control Operating Range" p.19
Is the remote control too far from the projector?	The operating range for the remote control is about 6 m. ☛ "Remote Control Operating Range" p.19
Is direct sunlight or strong light from fluorescent lamps shining onto the remote receiver?	Set the projector up in a location where strong light does not shine onto the remote receiver. ☛ Settings - Remote Receiver p.119
Is the correct setting for the Remote Receiver selected?	Check the Remote Receiver from the Configuration menu. ☛ Settings - Remote Receiver p.119
Are the batteries dead or have the batteries been inserted correctly?	Insert new batteries in the correct direction. ☛ "Replacing the Remote Control Batteries" p.18

I Want to Change the Language for Messages and Menus

Check	Remedy
Change the Language setting.	Adjust the Language setting from the Configuration menu. ☛ Extended - Language p.120

Mail is Not Received even if a Problem Occurs in the Projector

Check	Remedy
Is Standby Mode set to Communication On ?	To use the Mail Notification function when the projector is in standby, set Communication On in Standby Mode from the Configuration menu. ☛ ECO - Standby Mode p.133
Did a fatal abnormality occur and the projector come to a sudden stop?	When the projector comes to a sudden stop, email cannot be sent. If the abnormal state continues, contact your local dealer or the nearest address provided in the Epson Projector Contact List. ☛ Epson Projector Contact List
Is power being supplied to the projector?	Check that your electrical outlet or power source is functioning correctly.

Check	Remedy
Is the Mail Notification function set correctly in the Configuration menu?	An error notification email is sent according to the Mail settings in the Configuration menu. Check if it is set correctly. ☛ "Mail Menu" p.131

Cannot Change Settings Using a Web Browser

Check	Remedy
Are the user ID and password correct?	Enter "EPSONWEB" as the user ID. This cannot be changed. Enter the user ID even if the password setting is disabled. Enter the password you set in Web Control Password. The initial password is "admin".

Problems with the Interactive Features (EB-536Wi only)

Cannot Draw on the Projected Screen

Check	Remedy
Has pen calibration been performed correctly?	Make sure you perform pen calibration when using the interactive pen for the first time so that the projector recognizes the position of the pen correctly. Also, calibrate the pen again if you notice any discrepancy in positioning. ☛ "Pen Calibration" p.68
Is Pen Mode set to PC Interactive ?	Set Pen Mode to PC Free Annotation from the Configuration menu. ☛ Extended - Easy Interactive Function - Pen Mode p.123
Is the projector installed in direct sunlight from a window, or light from a fluorescent light?	When direct sunlight or light from a fluorescent light shines onto the projection screen or the projector, it could cause the interactive features to malfunction. Install the projector in a position where it is not subject to direct sunlight or light from a fluorescent light.

Cannot Operate a Computer from the Projected Screen After Connecting to the Computer

Check	Remedy
Is Extended set correctly?	<p>Make the following settings:</p> <ul style="list-style-type: none"> • Set Pen Mode to PC Interactive from the Configuration menu. <ul style="list-style-type: none"> ☛ Extended - Easy Interactive Function - Pen Mode p.123 • Set USB Type B to Easy Interactive Function or USB Display/Easy Interactive Function from the Configuration menu. When using USB Display, set USB Display/Easy Interactive Function. <ul style="list-style-type: none"> ☛ Extended - USB Type B p.120
Is the Pen Operation Mode set correctly?	<p>When using interactive pens as you would use a mouse, set the Pen Operation Mode to Two Users/Mouse or One User/Mouse from the Configuration menu.</p> <ul style="list-style-type: none"> ☛ Extended - Easy Interactive Function - Pen Operation Mode p.123
Is the USB cable connected correctly?	Check the USB cable connections. You may be able to resolve the problem by disconnecting and then reconnecting the USB cable.
If you are using a notebook computer when the battery power is running low, the USB port may stop working and you might not be able to use USB devices.	Connect the computer to a power source.

The Message "An error occurred in the Easy Interactive Function." is Displayed

Check	Remedy
An error has occurred in the interactive features.	<p>Contact the nearest address provided in the Epson Projector Contact List.</p> <ul style="list-style-type: none"> ☛ Epson Projector Contact List

Computer's Mouse Does Not Work Correctly

Check	Remedy
Is the interactive pen placed on the projection screen?	Remove the interactive pen from the projection screen.

The Interactive Pen Does Not Work

Check	Remedy
There is an obstacle in the signal route between the interactive pen and the projector.	Remove the obstacle. Also, do not block the signal route when standing in front of the projection screen.
The signal is interfering with other things such as a light source that is emitting infrared rays.	Do not use an infrared remote control or infrared microphone in the same room because the interactive pen may malfunction. Switch off the interfering device such as a light source that is emitting infrared rays.
The battery is low.	Press the button on the side of the pen to check the remaining battery power. If the battery light does not turn on, replace the battery. ☛ "Replacing the Battery for the Interactive Pen" p.20
The surrounding area is too bright.	Do not allow strong light to shine on the projected screen or the projector's Easy Interactive Function receiver.
Has pen calibration been performed correctly?	Make sure you perform pen calibration when using the interactive pen for the first time so that the projector recognizes the position of the pen correctly. Also, calibrate the pen again if you notice any discrepancy in positioning. ☛ "Pen Calibration" p.68
Are multiple projectors being used in the same room?	When using the interactive pen in the same room as multiple projectors, interference may cause pen operations to become unstable. Connect the optional Remote control cable set (ELPKC28). If you do not have a Remote control cable set, change the Distance of Projectors setting from the Configuration menu. ☛ "Connecting Multiple Projectors (EB-536Wi only)" p.38 ☛ Extended - Easy Interactive Function - General - Advanced - Distance of Projectors p.123

The Response Time for the Interactive Pen is Slow (Only when Projecting USB Display)



Check	Remedy
Is Windows Aero enabled? (Windows 7 and Windows Vista only)	Interactive pen operations may be slow when Windows Aero is enabled. Disable Windows Aero on the computer being used. Click All Programs - EPSON Projector - Epson USB Display - Epson USB Display Ver.x.xx Settings , and then select the Disable Windows Aero and improve the tracking of the interactive pen. checkbox.

The Dot Moves Automatically or Does Not Move to the Next Position During Manual Calibration

Check	Remedy
Information from the projection screen is not correctly received due to other things, such as a light source that is emitting infrared rays.	Move the device, such as a light source that is emitting infrared rays, away from the projector, or move the projector away from the device.
Information from the projection screen may not be received correctly if the projector is too close to the screen.	Setup within the recommended projection distance. ☛ "Screen Size and Projection Distance" p.173
The interactive pen is disabled due to unstable conditions in the surrounding area, such as a light source that is emitting infrared rays.	Move the projector or turn off the interfering device, such as a light source that is emitting infrared rays.

Check the numbers and then apply the following countermeasures. If you cannot resolve the problem, contact your network administrator, or contact your local dealer or the nearest address provided in the Epson Projector Contact List.

 [Epson Projector Contact List](#)

Event ID	Cause	Remedy
0432 0435	Failed to start EasyMP Network Projection.	Restart the projector.
0434 0482 0484 0485	Network communication is unstable.	Check the network communication status, and reconnect after waiting for a while.
0433	Cannot play transferred images.	Restart EasyMP Network Projection.
0481	Communication was disconnected from the computer.	
0483 04FE	EasyMP Network Projection ended unexpectedly.	Check the network communication status, and then restart the projector.
0479 04FF	A system error occurred in the projector.	Restart the projector.
0891	Cannot find an access point with the same SSID.	Set the computer, the access point, and the projector to the same SSID.
0892	The WPA/WPA2 authentication type does not match.	Check that the wireless LAN security settings are correct.
0893	The TKIP/AES encryption type does not match.	 Security p.129
0894	Communication was disconnected because the projector connected to an unauthorized access point.	Contact your network administrator for more information.
0898	Failed to acquire DHCP.	Check that the DHCP server is operating correctly. If you are not using DHCP, turn off the DHCP setting.  Wireless LAN - IP Settings p.127
0899	Other communication errors	If restarting the projector or EasyMP Network Projection does not solve the problem, contact your local dealer or the nearest address provided in the Epson Projector Contact List.  Epson Projector Contact List



Maintenance

This chapter provides information on maintenance procedures to ensure the best level of performance from the projector for a long time to come.

You should clean the projector if it becomes dirty or if the quality of projected images starts to deteriorate.



Caution

Before cleaning, turn off the projector's power and unplug the power cable. Otherwise, it could cause an electric shock.

Cleaning the Projector's Surface

Clean the projector's surface by wiping it gently with a soft cloth.

If the projector is particularly dirty, moisten the cloth with water containing a small amount of neutral detergent, and then firmly wring the cloth dry before using it to wipe the projector's surface.

Attention

Do not use volatile substances such as wax, alcohol, or thinner to clean the projector's surface. The quality of the case may change or become discolored.

Cleaning the Lens

Use a commercially available cloth for cleaning glasses to gently wipe the lens.



Warning

Do not use sprays that contain flammable gas to remove dust and lint from the lens. The projector may catch fire due to the high internal temperature of the lamp inside the projector.

Attention

Do not rub the lens with harsh materials or subject the lens to shocks as it can easily become damaged.

Cleaning the Air Filter

Clean the air filter and the air intake vent when the following message is displayed.

"The projector is overheating. Make sure nothing is blocking the air vent, and clean or replace the air filter."

Attention

- Dust collecting on the air filter may cause the internal temperature of the projector to rise, leading to a malfunction or early deterioration of optical parts. Clean the air filter immediately when the message is displayed.
- Do not rinse the air filter in water. Do not use detergents or solvents.

- 1** After you turn off the projector's power and the confirmation buzzer beeps twice, disconnect the power cord.
- 2** Open the air filter cover.
Place your finger into the groove at the top of the air filter cover, and pull down to open.

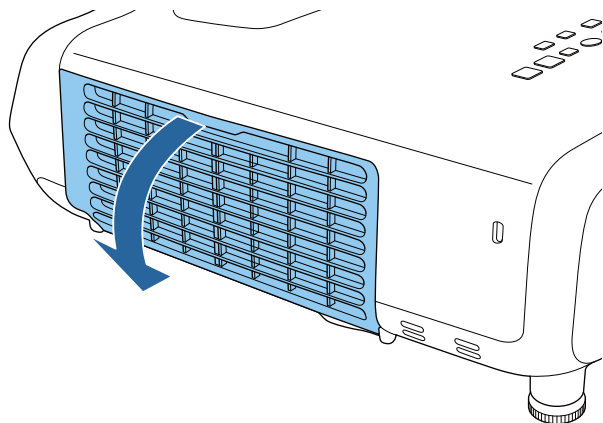

- 3** Remove the air filter.
Grip the tab in the center of the air filter, and pull the air filter straight out.

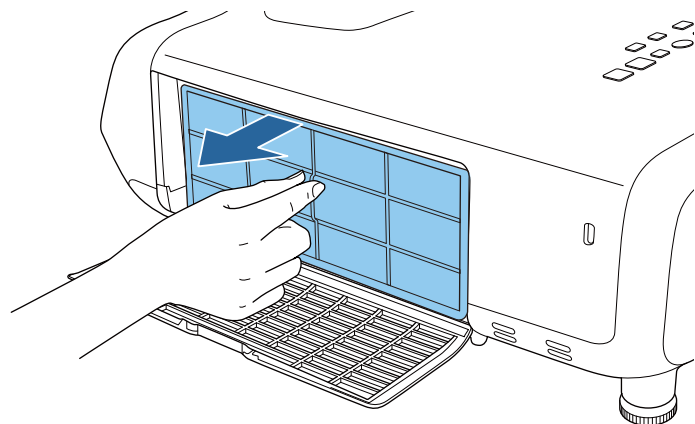

- 4** Remove any dust remaining on the air filter by using a vacuum cleaner from the front.

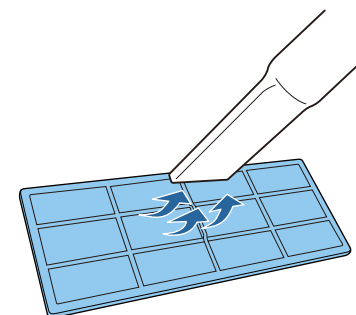

- 5** Replace the air filter.

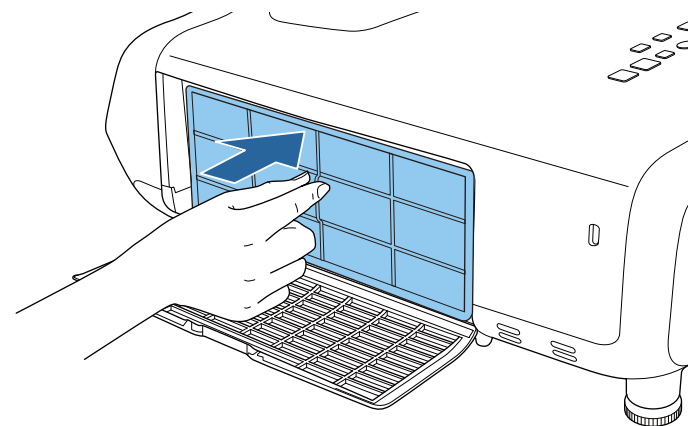

- 6** Close the air filter cover.

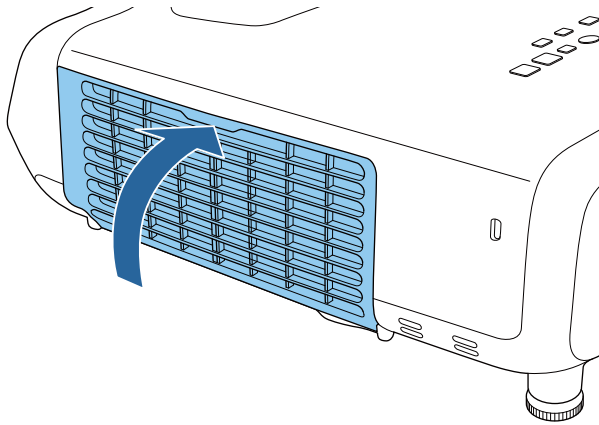

- If a message is frequently displayed, even after cleaning, it is time to replace the air filter. Replace it with a new air filter.
 - ☛ "Replacing the Air Filter" [p.169](#)
- It is recommended that you clean these parts at least once every three months. Clean them more often than this if using the projector in a particularly dusty environment.

This section explains how to replace the lamp and the air filter.

Replacing the Lamp

Lamp Replacement Period

It is time to replace the lamp when:

- The following message is displayed.
"Time to replace the lamp. Please contact your Epson projector reseller or visit www.epson.com to purchase."

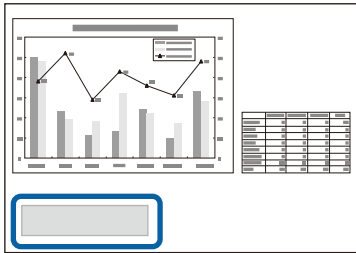

The message is displayed for 30 seconds.

- The power indicator is flashing blue, and the lamp indicator is flashing orange.

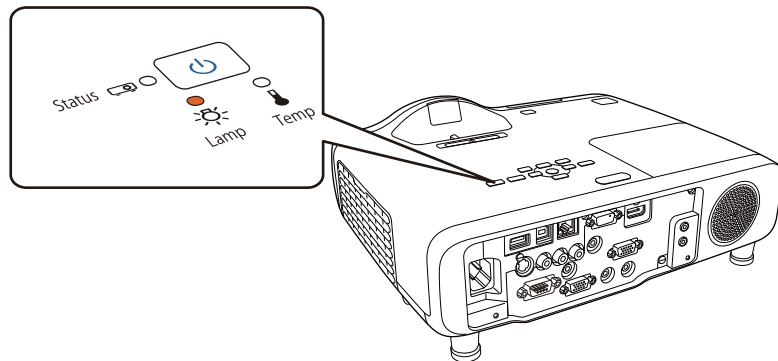

- The projected image gets darker or starts to deteriorate.

Attention

- The lamp replacement message is set to appear after the following time periods in order to maintain the initial brightness and quality of the projected images.

When **Power Consumption** is set to **Normal**: About 4,900 hours

When **Power Consumption** is set to **ECO**: About 9900 hours

☛ **ECO - Power Consumption** [p.133](#)

- If you continue to use the lamp after the replacement period has passed, the possibility that the lamp may explode increases. When the lamp replacement message is displayed, replace the lamp with a new one as soon as possible, even if it is still working.
- Do not repeatedly turn off the power and immediately back on. Turning the power on and off frequently may shorten the lamp's operating life.
- Depending on the individual characteristics of the lamp and the way it has been used, the lamp may become darker or stop working before the message is displayed. You should always have a spare lamp unit ready in case it is needed.
- We recommend the use of genuine EPSON option lamps. The use of non-genuine lamps may affect projection quality and safety. Any damage or malfunction caused by the use of non-genuine lamps may not be covered by Epson's warranty.



We recommend that you clean the air filter whenever you replace the lamp.

☛ "Cleaning the Air Filter" [p.163](#)

How to Replace the Lamp

The lamp can be replaced even when the projector is suspended from a wall or ceiling.

Warning

- When replacing the lamp because it has stopped working, there is a possibility that the lamp may be cracked. When replacing the lamp of a projector that has been installed on a wall or ceiling, assume that the lamp is cracked and stand to the side of the lamp cover, not underneath it. Also, remove the lamp cover gently. Be careful when removing the lamp cover as shards of glass may fall out and could cause an injury. If any shards of glass get into your eyes or mouth, contact your local physician immediately.
- Never disassemble or modify a lamp. If a modified or disassembled lamp is installed in the projector and used, it could cause a fire, electric shock, or an accident.

Caution

Wait until the lamp has cooled down sufficiently before removing the lamp cover. If the lamp is still hot, burns or other injuries may result. It takes approximately one hour after the power has been turned off for the lamp to sufficiently cool down.

- 1** After you turn off the projector's power and the confirmation buzzer beeps twice, disconnect the power cord.
- 2** Wait until the lamp has sufficiently cooled down, and then remove the lamp cover at the top of the projector.
Loosen the Lamp cover fixing screw with the screwdriver supplied with the new lamp unit or a cross-head screwdriver. Slide the lamp cover straight forward and remove it.

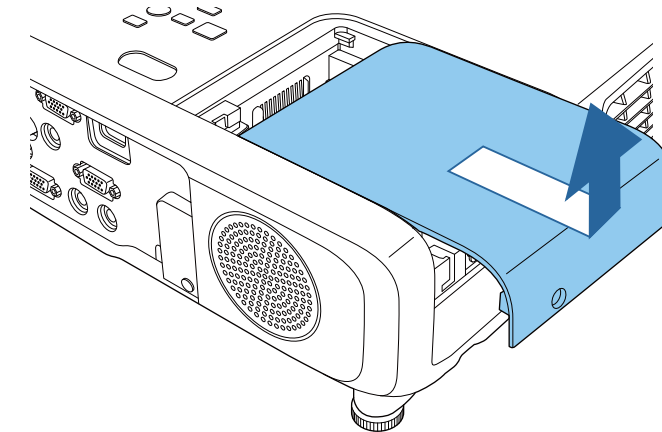
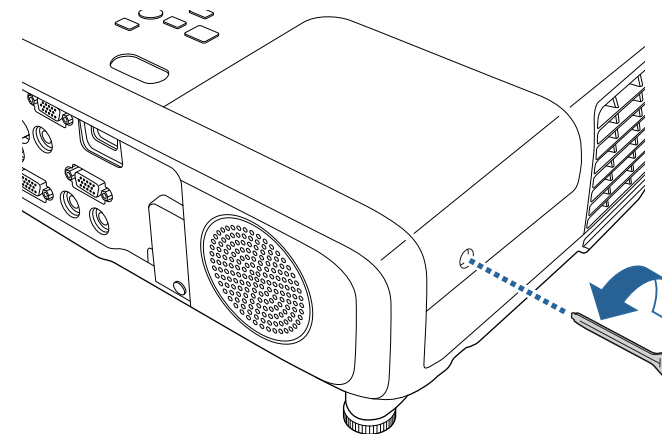

- 3** Loosen the two lamp fixing screws.

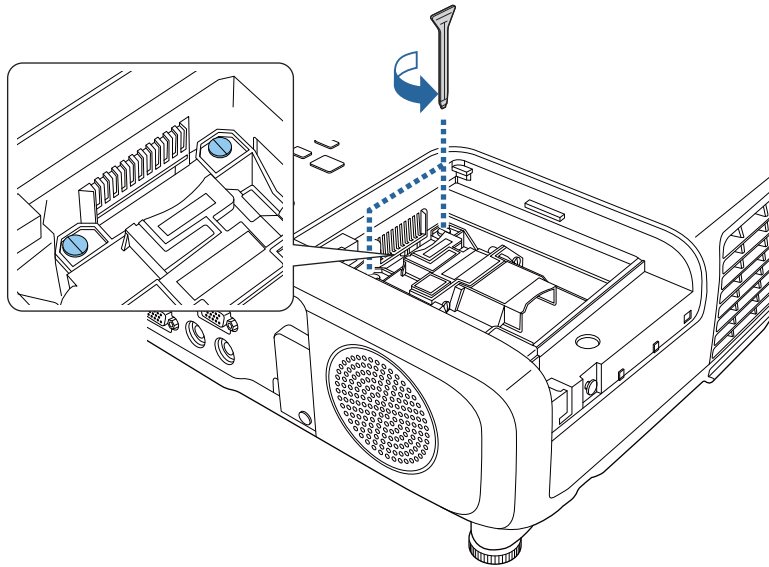

- 4** Grip the raised section of the old lamp and remove it.
If the Lamp is cracked, replace it with a new lamp, or contact your local dealer for further advice.

☛ [Epson Projector Contact List](#)

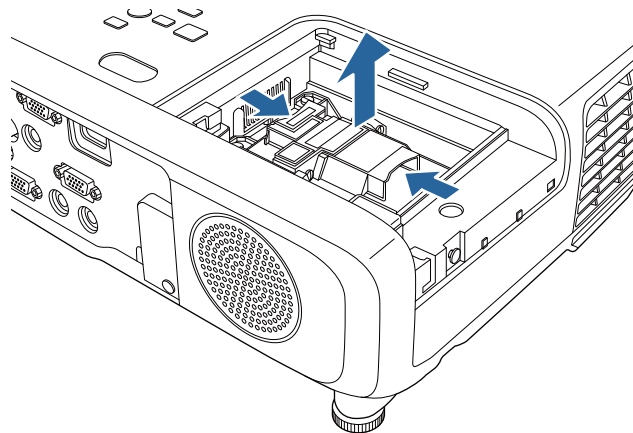

- 5** Install the new lamp.
Insert the new Lamp along the guide rail in the correct direction so that it fits in place, push in firmly, and once it is fully inserted tighten the two screws.

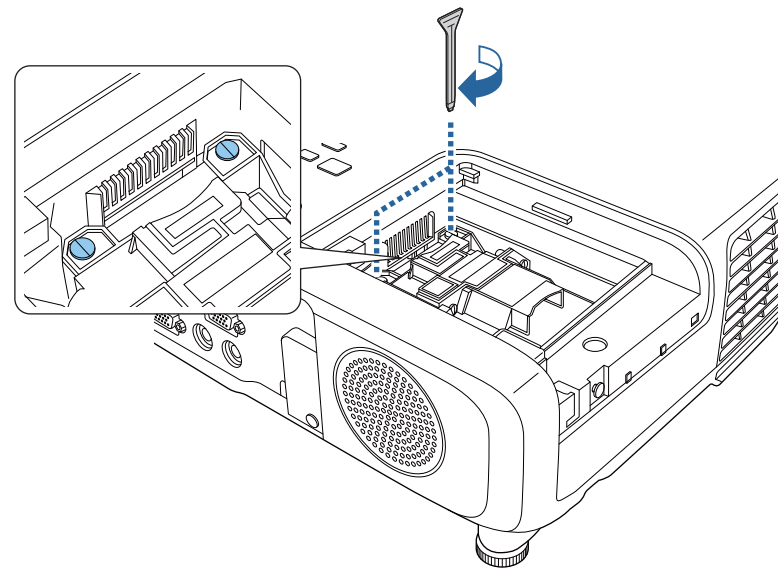
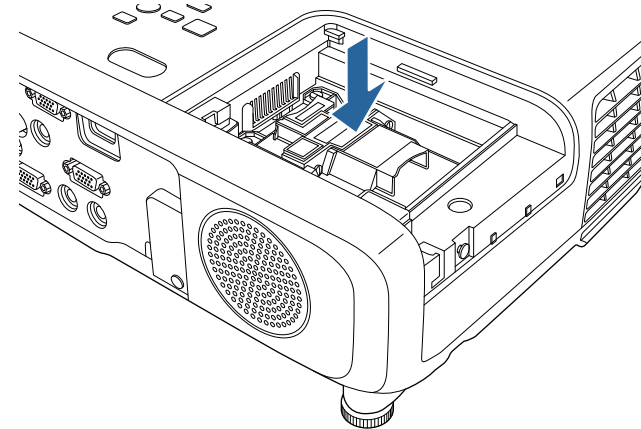

- 6** Replace the lamp cover.

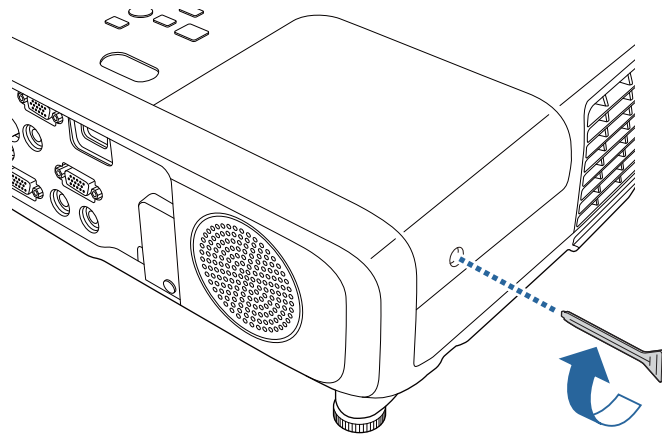

Attention

- Make sure you install the lamp and lamp cover securely. If the lamp cover is removed, the lamps turn off automatically as a safety precaution. If the lamp or the lamp cover is not installed correctly, the lamp will not turn on. Make sure the lamp cover is not loose or deformed.
- This product includes a lamp component that contains mercury (Hg). Please consult your local regulations regarding disposal or recycling. Do not dispose of it with normal waste.

Resetting the Lamp Hours

The projector records how long the lamp is on and a message and indicator notify you when it is time to replace the lamp. After replacing the lamp, make sure you reset the Lamp Hours from the Reset menu.

☛ **Reset - Reset Lamp Hours** [p.134](#)



Only reset the lamp hours after the lamp has been replaced. Otherwise, the lamp replacement period will not be indicated correctly.

Replacing the Air Filter

Air Filter Replacement Period

If the message is displayed frequently even though the air filter has been cleaned, replace the air filter.

How to Replace the Air Filter

The air filter can be replaced even when the projector is suspended from a wall or ceiling.

- 1** After you turn off the projector's power and the confirmation buzzer beeps twice, disconnect the power cord.
- 2** Open the air filter cover.
Place your finger into the groove at the top of the air filter cover, and pull down to open.

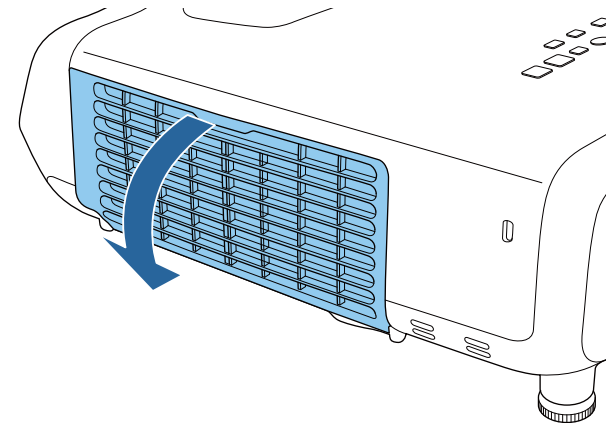

- 3** Remove the air filter.
Grip the tab in the center of the air filter, and pull the air filter straight out.

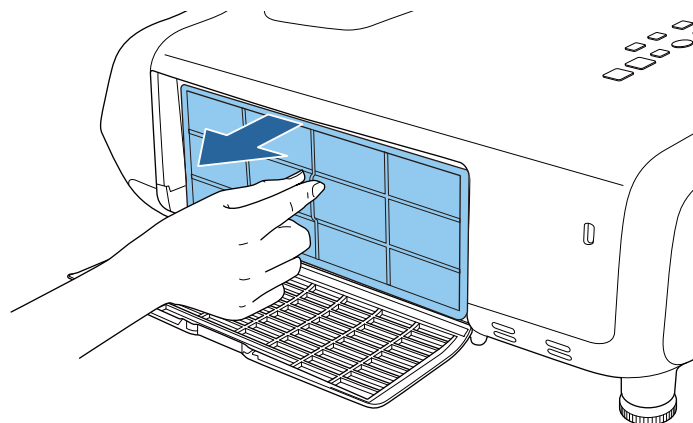

- 4** Install the new air filter.

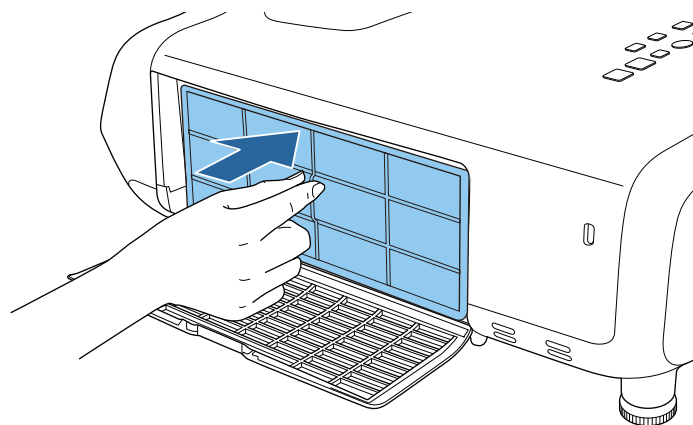

- 5** Close the air filter cover.

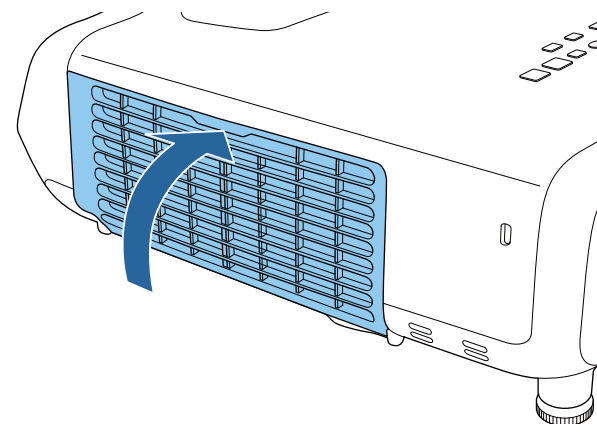

Dispose of used air filters properly in accordance with your local regulations.
Material of the frame part: ABS
Material of the filter part: Polyurethane foam



Appendix

The following optional accessories and consumables are available. Please purchase these products as and when needed. The following list of optional accessories and consumables is current as of: August, 2014. Details of accessories are subject to change without notice.

Optional Accessories

Wireless LAN unit ELPAP07

Use this to project images from a computer via a wireless communication.

Quick Wireless Connection USB Key ELPAP09

Use when you want to quickly establish one-to-one connection between the projector and a computer with Windows installed.

Document Camera ELPDC06/ELPDC11/ELPDC12/ELPDC20

Use when projecting images such as books, OHP documents, or slides.

Interface box ELPCB02

When the projector is mounted on a wall or suspended from a ceiling, install the remote control to operate the projector at hand.

Soft carrying case ELPKS66

A soft case to carry the projector.

Computer cable ELPKC02

(1.8 m - for mini D-Sub15-pin/mini D-Sub 15pin)

Computer cable ELPKC09

(3 m - for mini D-Sub15-pin/mini D-Sub 15pin)

Computer cable ELPKC10

(20 m - for mini D-Sub15-pin/mini D-Sub 15pin)

Remote control cable set*2 ELPKC28

Cables to connect multiple projectors that support the interactive features.

USB extension cable ELPKC31

Connect to a USB cable if the USB cable is too short.

Component video cable ELPKC19

(3 m - for mini D-Sub 15-pin/RCA male×3)

Use to connect a [component video](#) source.

Ceiling pipe (450 mm)*1 ELPFP13

Ceiling pipe (700 mm)*1 ELPFP14

Use when installing the projector on a high ceiling.

Ceiling mount*1 ELPMB23

Use when installing the projector on a ceiling.

Wall mount*1 ELPMB45

Use this arm type fitting when installing the projector on a wall.

Easy Interactive Pen*2 ELPPN04A/ELPPN04B

Pens for the interactive features. You cannot use Easy Interactive Pens with the same model number at the same time.

Interactive Pen Extension*2 ELPPE02

Attach to the Easy Interactive Pen to extend the pen and use it as a pointer.

Replacement Pen Tips*2 ELPPS02

Replacement pen tips for the Easy Interactive Pen.

*1 Special expertise is required to suspend the projector from a ceiling or mount it on a wall. Contact your local dealer or the nearest address provided in the Epson Projector Contact List.

 [Epson Projector Contact List](#)

*2 EB-536Wi only.

Consumables

Lamp unit ELPLP87

Use as a replacement for used lamps.

Air filter ELPAF47

Use as a replacement for used air filters.

Projection Distance (for EB-536Wi/EB-535W/EB-525W)

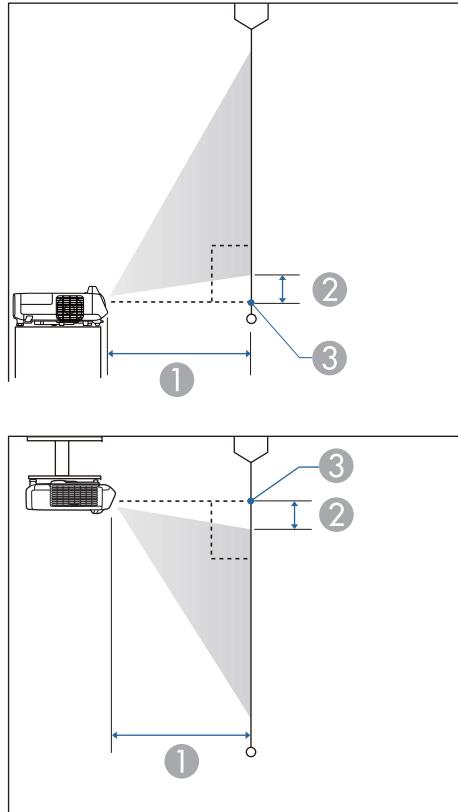

- ① Projection distance (from lens to screen)
- ② Distance from the center of the receiver's lens to the base of the screen (or to the top of the screen, if suspended from a wall or ceiling)
- ③ Center of lens

Unit: cm

4:3 Screen Size		①	②
		Minimum (Wide) to Maximum (Tele)	Minimum (Wide)
50"	100 x 76	58 - 79	9
60"	120 x 91	70 - 96	11
70"	140 x 105	82 - 112	13
80"	160 x 120	94*	14
90"	180 x 135	107*	16
102"	207 x 155	121*	18

* Project using Wide (maximum zoom).

Unit: cm

16:9 Screen Size		①	②
		Minimum (Wide) to Maximum (Tele)	Minimum (Wide)
60"	130 x 75	63 - 87	14
70"	150 x 87	74 - 101	16
80"	180 x 100	85 - 116	19
90"	200 x 110	97*	21
100"	220 x 120	108*	23
113"	250 x 141	122*	26

* Project using Wide (maximum zoom).

Unit: cm

16:10 Screen Size		①	②
		Minimum (Wide) to Maximum (Tele)	Minimum (Wide)
55"	115 x 72	56 - 77	9
60"	130 x 81	61 - 84	9

16:10 Screen Size		①	②
		Minimum (Wide) to Maximum (Tele)	Minimum (Wide)
70"	150 x 94	72 - 99	11
80"	170 x 110	83 - 113	13
90"	190 x 120	94*	14
100"	220 x 130	105*	16
116"	251 x 157	122*	18

* Project using Wide (maximum zoom).

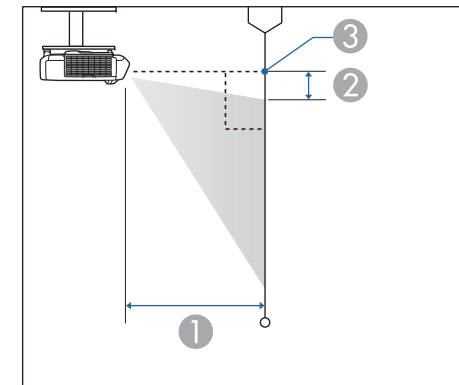

- ① Projection distance (from lens to screen)
- ② Distance from the center of the receiver's lens to the base of the screen (or to the top of the screen, if suspended from a wall or ceiling)
- ③ Center of lens

Projection Distance (For EB-530/EB-520)

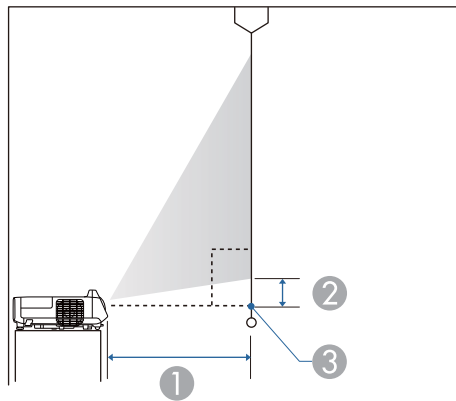

Unit: cm

4:3 Screen Size		①	②
		Minimum (Wide) to Maximum (Tele)	Minimum (Wide)
50"	100 x 76	55 - 75	6
60"	120 x 91	66 - 90	8
70"	140 x 105	78 - 106	9
80"	160 x 120	89 - 122	10
90"	180 x 135	101*	12
100"	200 x 150	112*	13
108"	219 x 165	122*	14

* Project using Wide (maximum zoom).

Unit: cm

16:9 Screen Size		①	②
		Minimum (Wide) to Maximum (Tele)	Minimum (Wide)
50"	110 x 62	60 - 82	17
60"	130 x 75	72 - 99	21
70"	150 x 87	85 - 116	24
80"	180 x 100	98*	28
90"	200 x 110	110*	31
99"	219 x 123	121*	34

* Project using Wide (maximum zoom).

Supported Resolutions

Computer Signals (analog RGB)

Signal	Refresh Rate (Hz)	Resolution (dots)
VGA	60/72/75/85	640 x 480
SVGA	56/60/72/75/85	800 x 600
XGA	60/70/75/85	1024 x 768
WXGA	60	1280 x 768
	60	1366 x 768
	60/75/85	1280 x 800
WXGA+	60/75/85	1440 x 900
WXGA++	60	1600 x 900
SXGA	70/75/85	1152 x 864
	60/75/85	1280 x 1024
	60/75/85	1280 x 960
SXGA+	60/75	1400 x 1050
WSXGA+*1,2	60	1680 x 1050
UXGA	60	1600 x 1200
MAC13"	67	640 x 480
MAC16"	75	832 x 624
MAC19"	75	1024 x 768
	59	1024 x 768
MAC21"	75	1152 x 870

*1 EB-536Wi/EB-535W/EB-525W only.

*2 Only compatible when **Wide** is selected as the **Resolution** from the Configuration menu.

Even when signals other than those mentioned above are input, it is likely that the image can be projected. However, not all functions may be supported.

Component Video

Signal	Refresh Rate (Hz)	Resolution (dots)
SDTV (480i)	60	720 x 480
SDTV (576i)	50	720 x 576
SDTV (480p)	60	720 x 480
SDTV (576p)	50	720 x 576
HDTV (720p)	50/60	1280 x 720
HDTV (1080i)	50/60	1920 x 1080

Composite Video

Signal	Refresh Rate (Hz)	Resolution (dots)
TV (NTSC)	60	720 x 480
TV (SECAM)	50	720 x 576
TV (PAL)	50/60	720 x 576

Input Signal from the HDMI Port

Signal	Refresh Rate (Hz)	Resolution (dots)
VGA	60	640 x 480
SVGA	60	800 x 600
XGA	60	1024 x 768
WXGA	60	1280 x 800
	60	1366 x 768

Signal	Refresh Rate (Hz)	Resolution (dots)
WXGA+	60	1440 x 900
WXGA++	60	1600 x 900
SXGA	60	1280 x 960
	60	1280 x 1024
SXGA+	60	1400 x 1050
UXGA	60	1600 x 1200
WSXGA+*	60	1680 x 1050
SDTV (480i/480p)	60	720 x 480
SDTV (576i/576p)	50	720 x 576
HDTV (720p)	50/60	1280 x 720
HDTV (1080i)	50/60	1920 x 1080
HDTV (1080p)	24/30/50/60	1920 x 1080

* EB-536Wi/EB-535W/EB-525W only.

Projector General Specifications

Product name	EB-536Wi	EB-535W	EB-525W	EB-530	EB-520	
Dimensions	344 (W) x 94 (H) x 314.5 (D) mm (not including the feet)					
LCD panel size	0.59" Wide			0.55"		
Display method	Polysilicon TFT active matrix					
Resolution	1,024,000 WXGA (1280 (W) x 800 (H) dots) x 3			786,432 XGA (1024 (W) x 768 (H) dots) x 3		
Focus adjustment	Manual					
Zoom adjustment	Digital (1-1.35)					
Lamp	UHE lamp, 215 W Model No.: ELPLP87	UHE lamp, 200 W Model No.: ELPLP87	UHE lamp, 215 W Model No.: ELPLP87	UHE lamp, 200 W Model No.: ELPLP87	UHE lamp, 200 W Model No.: ELPLP87	
Max. audio output	16 W					
Speaker	1					
Power supply	100 - 240 V AC \pm 10% 50/60 Hz 3.2 - 1.4 A	100 - 240 V AC \pm 10% 50/60 Hz 3.0 - 1.3 A	100 - 240 V AC \pm 10% 50/60 Hz 3.2 - 1.4 A	100 - 240 V AC \pm 10% 50/60 Hz 3.0 - 1.3 A	100 - 240 V AC \pm 10% 50/60 Hz 3.0 - 1.3 A	
Power consumption	100 to 120 V area	Operating: 315 W Standby power consumption (Communication On): 1.90 W Standby power consumption (Communication Off): 0.22 W	Operating: 315 W Standby power consumption (Communication On): 1.90 W Standby power consumption (Communication Off): 0.22 W	Operating: 293 W Standby power consumption (Communication On): 1.90 W Standby power consumption (Communication Off): 0.22 W	Operating: 315 W Standby power consumption (Communication On): 1.90 W Standby power consumption (Communication Off): 0.22 W	Operating: 293 W Standby power consumption (Communication On): 1.90 W Standby power consumption (Communication Off): 0.22 W

	220 to 240 V area	Operating: 230 W Standby power consumption (Communication On): 2.10 W Standby power consumption (Communication Off): 0.28 W	Operating: 230 W Standby power consumption (Communication On): 2.10 W Standby power consumption (Communication Off): 0.28 W	Operating: 229 W Standby power consumption (Communication On): 2.10 W Standby power consumption (Communication Off): 0.28 W	Operating: 230 W Standby power consumption (Communication On): 2.10 W Standby power consumption (Communication Off): 0.28 W	Operating: 229 W Standby power consumption (Communication On): 2.10 W Standby power consumption (Communication Off): 0.28 W
Operating altitude	Altitude 0 to 3,000 m					
Operating temperature	+5 to +35°C (No condensation) (Altitude 0 to 2,286 m) +5 to +30°C (No condensation) (Altitude 2,287 to 3,000 m)					
Storage temperature	-10 to +60°C (No condensation)					
Mass	Approx. 3.9 kg	Approx. 3.7 kg	Approx. 3.7 kg	Approx. 3.7 kg	Approx. 3.7 kg	Approx. 3.7 kg

Connectors	Computer1 port	1	Mini D-Sub15-pin (female)
	Computer2 port	1	Mini D-Sub15-pin (female)
	Video port	1	RCA pin jack
	S-Video port	1	Mini DIN 4-pin
	Audio1 port	1	Stereo mini jack
	Audio2 port	1	Stereo mini jack
	Audio-L/R port	1	RCA pin jack x 2 (L-R)
	Mic port	1	Stereo mini jack
	Audio Out port	1	Stereo mini jack
	Monitor Out port	1	Mini D-Sub15-pin (female)
	HDMI port	1	HDMI (Audio is only supported by PCM)
	USB-A port*1	1	USB connector (Type A)
	USB-B port*1	1	USB connector (Type B)
	LAN port	1	RJ-45
	RS-232C port	1	Mini D-Sub 9-pin (male)
SYNC port*2	2	Stereo mini jack	

*1 Supports USB 2.0. However, USB ports are not guaranteed to operate all devices that support USB.

*2 EB-536Wi only.

This product is also designed for IT power distribution system with phase-to-phase voltage 230V.

Angle of tilt

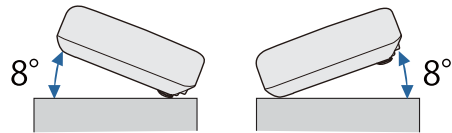

If you use the projector tilted at an angle of more than 8° it could be damaged and cause an accident.

DECLARATION of CONFORMITY

According to 47CFR, Part 2 and 15

Class B Personal Computers and Peripherals; and/or
CPU Boards and Power Supplies used with Class B Personal Computers

We: Epson America, Inc.
Located at: 3840 Kilroy Airport Way
MS: 3-13
Long Beach, CA 90806
Tel: 562-981-3840

Declare under sole responsibility that the product identified herein, complies with 47CFR Part 2 and 15 of the FCC rules as a Class B digital device. Each product marketed, is identical to the representative unit tested and found to be compliant with the standards. Records maintained continue to reflect the equipment being produced can be expected to be within the variation accepted, due to quantity production and testing on a statistical basis as required by 47CFR 2.909. Operation is subject to the following two conditions : (1) this device may not cause harmful interference, and (2) this device must accept any interference received, including interference that may cause undesired operation.

Trade Name: EPSON
Type of Product: LCD Projector
Model: H598C/H599C/H600C/H601C/H602C/H603C/
H604C/H605C

**FCC Compliance Statement
For United States Users**

This equipment has been tested and found to comply with the limits for a Class B digital device, pursuant to Part 15 of the FCC Rules. These limits are designed to provide reasonable protection against harmful interference in a residential installation. This equipment generates, uses, and can radiate radio frequency energy and, if not installed and used in accordance with the instructions, may cause harmful interference to radio communications. However, there is no guarantee that interference will not occur in a particular installation. If this equipment does cause interference to radio and television reception, which can be determined by turning the equipment off and on, the user is encouraged to try to correct the interference by one or more of the following measures.

- Reorient or relocate the receiving antenna.
- Increase the separation between the equipment and receiver.
- Connect the equipment into an outlet on a circuit different from that to which the receiver is connected.
- Consult the dealer or an experienced radio/TV technician for help.

WARNING

The connection of a non-shielded equipment interface cable to this equipment will invalidate the FCC Certification or Declaration of this device and may cause interference levels which exceed the limits established by the FCC for this equipment. It is the responsibility of the user to obtain and use a shielded equipment interface cable with this device. If this equipment has more than one interface connector, do not leave cables connected to unused interfaces. Changes or modifications not expressly approved by the manufacturer could void the user's authority to operate the equipment.



FCC Statement for Verification

This device complies with Part 15 of the FCC Rules. Operation is subject to the following two conditions:(1) this device may not cause harmful interference, and (2) this device must accept any interference received, including interference that may cause undesired operation.

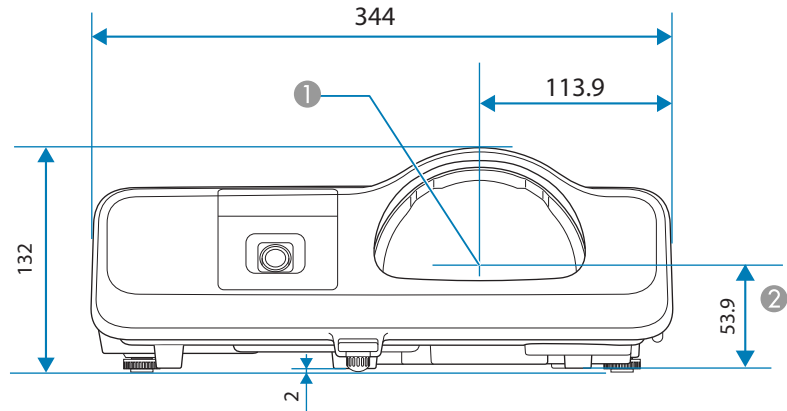

- ① Center of lens
- ② Measurements from the center of the lens to the wall mount plate fixing points or the ceiling mount fixing points.

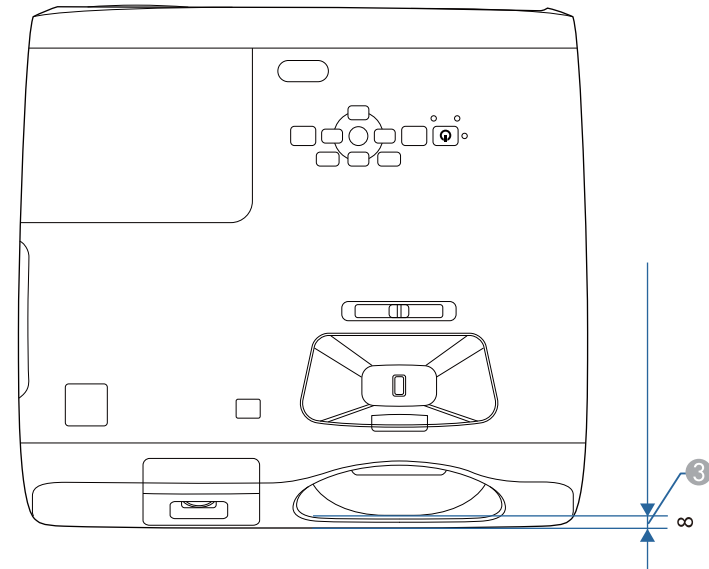

- ③ Measurements from the front of the projector to the front of the lens.

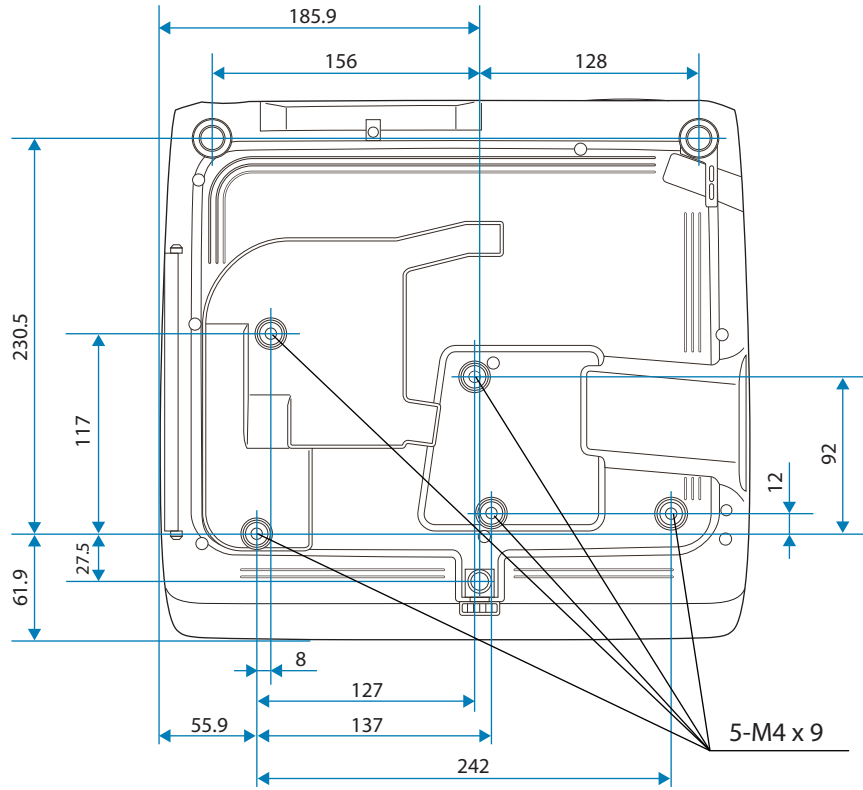

Units: mm

This section briefly explains the difficult terms that are not explained in the text of this guide. For details, refer to other commercially available publications.

Ad hoc mode	A method of wireless LAN connection that communicates with wireless LAN clients without using an access point.
AMX Device Discovery	AMX Device Discovery is a technology developed by AMX to facilitate AMX control systems for easy operation of the target equipment. Epson have implemented this protocol technology, and have provided a setting to enable the protocol function (ON). See the AMX Web site for more details. URL http://www.amx.com/
Aspect Ratio	The ratio between an image's length and its height. Screens with a horizontal:vertical ratio of 16:9, such as HDTV screens, are known as wide screens. SDTV and general computer displays have an aspect ratio of 4:3.
Component Video	A method that separates the video signal into a luminance component (Y), and a blue minus luminance (Cb or Pb) and a red minus luminance (Cr or Pr).
Composite video	A method that combines the video signal into a luminance component and a color component for transmission down a single cable.
Contrast	The relative brightness of the light and dark areas of an image can be increased or decreased to make text and graphics stand out more clearly, or to make them appear softer. Adjusting this particular property of an image is called contrast adjustment.
DHCP	An abbreviation of Dynamic Host Configuration Protocol, this protocol automatically assigns an IP address to equipment connected to a network.
Gateway Address	This is a server (router) for communicating across a network (subnet) divided according to subnet mask .
HDCP	HDCP is an abbreviation for High-bandwidth Digital Content Protection. It is used to prevent illegal copying and protect copyrights by encrypting digital signals sent over DVI and HDMI ports. Because the HDMI port on this projector supports HDCP, it can project digital images protected by HDCP technology. However, the projector may not be able to project images protected with updated or revised versions of HDCP encryption.
HDTV	An abbreviation for High-Definition Television that refers to high-definition systems which satisfy the following conditions. <ul style="list-style-type: none"> • Vertical resolution of 720p or 1080i or greater (p = Progressive, i = Interlace) • Screen aspect ratio of 16:9
Infrastructure mode	A method for wireless LAN connection in which devices communicate through access points.
Interlace	Transmits information needed to create one screen by sending every other line, starting from the top of the image and working down to the bottom. Images are more likely to flicker because one frame is displayed every other line.
IP Address	A number to identify a computer connected to a network.
Progressive	Projects information to create one screen at a time, displaying the image for one frame. Even though the number of scan lines is the same, the amount of flicker in images decreases because the volume of information has doubled compared with an interlace system.
Refresh Rate	The light-emitting element of a display maintains the same luminosity and color for an extremely short time. Because of this, the image must be scanned many times per second to refresh the light-emitting element. The number of refresh operations per second is called the Refresh rate and is expressed in hertz (Hz).

SDTV	An abbreviation for Standard Definition Television that refers to standard television systems which do not satisfy the conditions for HDTV ▶ High-Definition Television.
SNMP	An abbreviation for Simple Network Management Protocol, which is the protocol for monitoring and controlling devices such as routers and computers connected to a TCP/IP network.
sRGB	An international standard for color intervals that was formulated so that colors that are reproduced by video equipment can be handled easily by computer operating systems (OS) and the Internet. If the connected source has an sRGB mode, set both the projector and the connected signal source to sRGB.
SSID	SSID is identification data for connecting to another device on a wireless LAN. Wireless communication is possible between devices that correspond to SSID.
Subnet Mask	This is a numerical value that defines the number of bits used for the network address on a divided network (subnet) from the IP address.
SVGA	A screen size standard with a resolution of 800 (horizontal) x 600 (vertical) dots.
S-Video	A method that separates the video signal into a luminance component (Y) and a color component (C).
SXGA	A screen size standard with a resolution of 1,280 (horizontal) x 1,024 (vertical) dots.
Sync.	The signals output from computers have a specific frequency. If the projector frequency does not match this frequency, the resulting images are not of a good quality. The process of matching the phases of these signals (the relative position of the crests and the troughs in the signal) is called Synchronization. If the signals are not synchronized, flickering, blurriness, and horizontal interference occur.
Tracking	The signals output from computers have a specific frequency. If the projector frequency does not match this frequency, the resulting images are not of a good quality. The process of matching the frequency of these signals (the number of crests in the signal) is called Tracking. If Tracking is not carried out correctly, wide vertical stripes appear in the signal.
Trap IP Address	This is the IP address ▶ for the destination computer used for error notification in SNMP.
VGA	A screen size standard with a resolution of 640 (horizontal) x 480 (vertical) dots.
XGA	A screen size standard with a resolution of 1,024 (horizontal) x 768 (vertical) dots.

All rights reserved. No part of this publication may be reproduced, stored in a retrieval system, or transmitted in any form or by any means, electronic, mechanical, photocopying, recording, or otherwise, without the prior written permission of Seiko Epson Corporation. No patent liability is assumed with respect to the use of the information contained herein. Neither is any liability assumed for damages resulting from the use of the information contained herein.

Neither Seiko Epson Corporation nor its affiliates shall be liable to the purchaser of this product or third parties for damages, losses, costs, or expenses incurred by the purchaser or third parties as a result of: accident, misuse, or abuse of this product or unauthorized modifications, repairs, or alterations to this product, or (excluding the U.S.) failure to strictly comply with Seiko Epson Corporation's operating and maintenance instructions.

Seiko Epson Corporation shall not be liable against any damages or problems arising from the use of any options or any consumable products other than those designated as Original Epson Products or Epson Approved Products by Seiko Epson Corporation.

The contents of this guide may be changed or updated without further notice.

Illustrations in this guide and the actual projector may differ.

Restriction of Use

When this product is used for applications requiring high reliability/safety such as transportation devices related to aviation, rail, marine, automotive etc.; disaster prevention devices; various safety devices etc; or functional/precision devices etc, you should use this product only after giving consideration to including fail-safes and redundancies into your design to maintain safety and total system reliability. Because this product was not intended for use in applications requiring extremely high reliability/safety such as aerospace equipment, main communication equipment, nuclear power control equipment, or medical equipment related to direct medical care etc, please make your own judgment on this product's suitability after a full evaluation.

Wireless Telegraphy Act Regulations

The following acts are prohibited by the Wireless Telegraphy Act.

- Modifying and disassembling (including the antenna)
- Removing the label of conformance

About Notations

Microsoft® Windows® 2000 operating system
Microsoft® Windows® XP operating system
Microsoft® Windows Vista® operating system
Microsoft® Windows® 7 operating system
Microsoft® Windows® 8 operating system
Microsoft® Windows® 8.1 operating system

In this guide, the operating systems above are referred to as "Windows 2000", "Windows XP", "Windows Vista", "Windows 7", "Windows 8", and "Windows 8.1". Furthermore, the collective term Windows may be used to refer to Windows 2000, Windows XP, Windows Vista, Windows 7, Windows 8, and Windows 8.1, and multiple versions of Windows may be referred to as, for example, Windows 2000/XP/Vista/7/8/8.1, with the Windows notation omitted.

Mac OS X 10.3.x
Mac OS X 10.4.x
Mac OS X 10.5.x
Mac OS X 10.6.x
OS X 10.7.x
OS X 10.8.x
OS X 10.9.x

In this guide, the operating systems above are referred to as "Mac OS X 10.3.x", "Mac OS X 10.4.x", "Mac OS X 10.5.x", "Mac OS X 10.6.x", "OS X 10.7.x", "OS X 10.8.x", and "OS X 10.9.x". Furthermore, the collective term "OS X" is used to refer to them all.

General Notice:

EPSON is a registered trademark, EXCEED YOUR VISION, ELPLP and their logos are registered trademarks or trademarks of Seiko Epson Corporation.

Mac, Mac OS, and OS X, are trademarks of Apple Inc.

Microsoft, Windows, Windows Vista, PowerPoint, and Windows logo are trademarks or registered trademarks of Microsoft Corporation in the United States and/or other countries.

eneloop® is a registered trademark of the Panasonic Group.

WPA™ and WPA2™ are registered trademarks of Wi-Fi Alliance.

App Store is a service mark of Apple Inc.

Google play is a trademark of Google Inc.

HDMI and High-Definition Multimedia Interface are the trademarks or registered trademarks of HDMI Licensing LLC. 

PJLink trademark is a trademark applied for registration or is already registered in Japan, the United States of America and other countries and areas.

Crestron and Crestron RoomView are registered trademarks of Crestron Electronics, Inc.

All other trademarks are the property of their respective owners and used for identification purpose only.

©SEIKO EPSON CORPORATION 2014. All rights reserved.

Indication of the manufacturer and the importer in accordance with requirements of directive 2011/65/EU (RoHS)

Manufacturer: SEIKO EPSON CORPORATION

Address: 3-5, Owa 3-chome, Suwa-shi, Nagano-ken 392-8502 Japan

Telephone: 81-266-52-3131

Importer: SEIKO EUROPE B.V.

Address: Azië building, Atlas ArenA, Hoogoorddreef 5, 1101 BA Amsterdam Zuidoost
The Netherlands

Telephone: 31-20-314-5000

A

A/V Mute 12, 17, 90, 104
 A/V Mute Timer 134
 A/V Output 122
 A/V Settings 122
 Adjusting the tilt 52
 Advanced 123, 124
 Air exhaust vent 12
 Air filter 11, 172
 Air Filter Replacement Period 169
 Air intake vent 11
 AMX Device Discovery 132
 Annotation Mode 60, 75
 Anti-Theft Lock 101
 Aspect 16, 55, 118
 Attachment for optional strap or cord 20
 Audio Output 122
 Audio Settings 13
 Audio1 port 12
 Audio2 port 13
 Audio-L/R port 12
 Auto 16
 Auto Calibration 68, 123
 Auto Iris 54, 117
 Auto Power On 121
 Auto Setup 117
 Auto V-Keystone 52
 Automatic correction 52

B

Background 77
 Basic menu 126
 Battery cover 20

Battery light 20
 Blackboard 54
 Bonjour 132
 Brightness 116
 Button 20

C

Cable Layouts 106
 Ceiling 121
 Ceiling mount 172
 Ceiling mount fixing points 14
 Ceiling pipe 172
 Channel 127
 Cleaning 163
 Cleaning the air filter 163
 Cleaning the Lens 163
 Cleaning the Projector's Surface 163
 Color Adjustment 117
 Color Mode 18, 53, 116
 Color Saturation 116
 Color Temp. 117
 Command List 106
 Communications Protocol 107
 Component Video 176
 Component video cable 172
 Composite Video 176
 Computer 16, 104
 Computer cable 172
 Computer Interactive 62
 Computer Port 13
 Computer Signals 176
 Configuration menu 113, 114
 Connecting a computer 26

Connecting a LAN cable 35
 Connecting a microphone 32
 Connecting external equipment 33
 Connecting image sources 28
 Connecting multiple projectors 38
 Connecting USB devices 30
 Connection mode 127
 Consumables 172
 Continuous 89
 Contrast 116
 Control panel 11, 15
 Control Panel Lock 100
 Control panel lock 119
 Crestron RoomView 108, 132
 Cross 92

D

Direct Power On 121
 Display 121
 Display Background 121
 Display order 89
 Display settings 89
 Document Camera 172
 Dynamic 53

E

Easy Interactive Driver 65
 Easy Interactive Function 120, 122, 123
 Easy Interactive Function receiver 11
 Easy Interactive Pen 19, 172
 EasyMP Monitor 102
 EasyMP Network Projection 80
 ECO Display 134

- ECO menu 133
 Effect 89
 Electronic pen 67
 Email Address 131
 Enable Right Click 124
 Enter 15, 17
 Esc 15, 18
 ESC/VP21 106
 Extended menu 120
 E-Zoom 17, 92
- F**
- Flip Horizontal 8, 90
 Focus 53
 Focus ring 11
 Foot adjust lever 11
 Freeze 17, 91, 104
 Front 23, 121
 Front adjustable foot 11, 14
 Full Lock 100
- G**
- Gateway Address 128, 130
- H**
- H/V-Keystone 49
 HDMI 176
 HDMI port 13
 HDMI Video Range 118
 Help 15, 17
 Help function 142
 High Altitude Mode 121
 H-Keystone adjuster 51
 H-Keystone Slider 51
 Horizontal keystone adjuster 11
 Hovering 123
 How to Replace the Air Filter 169
 How to replace the lamp 166
- I**
- Image height 52
 Image menu 116
 Image Processing 118
 Image size 52
 Images 147, 148
 Indicators 15, 143
 Info menu 134
 Ink function 82, 83
 Input Signal 118
 Input signal 135
 Installing 23, 24, 46
 Interactive function 10, 24, 74, 157
 Interactive Pen Extension 172
 Interface box 172
 IP Address 131
 IP Address Display 128, 131
 IP Settings 128, 130
- K**
- Keystone 119
 Keystone distortion 48
- L**
- Lamp cover 11
 Lamp hours 133
 Lamp indicator 143
 Lamp replacement period 166
 Lamp unit 172
 LAN 18, 104
 LAN port 13
 Language 122
 Lens cover 12
 Light Optimizer 133
- M**
- Mail Notification 104, 131
 Mail Notification menu 131
 Manual Calibration 69, 123
 Manual corrections 49
 Menu 15, 16
 Message Broadcasting 102, 132
 Messages 121
 MHL Menu 18
 Mic Input Level 119
 Microphone input port 12
 Monitor Displays 176
 Monitor Out Port 12
 Mouse pointer 93
- N**
- Network Configuration 125
 Network information 124, 125
 Network Menu 124
 Noise Reduction 118
 Num 16
 Number pad 16
- O**
- Operating range 19

Operating temperature 179
 Operation 121
 Optional accessories 172
 Overheating 144
 Overscan 118

P

Page 17, 104
 Part Names and Functions 11
 Passphrase 129
 Password protect sticker 99
 Password Protection 98
 Pattern 120
 PC Free 8, 85, 86
 Pen 76
 Pen Calibration 68
 Pen input 82, 83
 Pen Mode 18, 123
 Pen Mode Icon 121
 Pen Operation Area 71
 Pen Operation Mode 124
 Pen tip 20
 PjLink 107
 PjLink Password 126
 Pointer 17, 91
 Pointer shape 119
 Port Number 131
 Position 118
 Power 15, 16, 104
 Power indicator 143
 Power inlet 12
 Power On Protection 98
 Presentation 54

Priority Gateway 132
 Problem Solving 143
 Progressive 118
 Projection 121
 Projection distance 173, 174
 Projection lens 11
 Projector 41, 42
 Projector control toolbar 77
 Projector General Specifications 178
 Projector Info 135
 Projector keyword 127
 Projector Name 126
 Projector Setup 102

Q

Quick Corner 49, 119
 Quick Wireless Connection USB Key 37, 172

R

Reading Mail 105
 Rear 23, 121
 Rear feet 14
 Rear screen 23
 Refresh 129
 Refresh Rate 135
 Remote control 16
 Remote control cable set 172
 Remote control light-emitting area 18
 Remote Receiver 119
 Remote receiver 11, 13
 Removing USB devices 31
 Replacement Pen Tips 172
 Replacing batteries 18, 20

Replacing the Air Filter 169
 Replacing the Lamp 166
 Replacing the tip 21
 Reset 117, 118, 120, 122, 133, 134
 Reset all 135
 Reset menu 133, 135
 Resetting the lamp operating time .. 135, 169
 Resolution 117, 135
 Rotating images 87
 RS-232C 12

S

Screen size 173
 Screen switching time 89
 Search Access Point 128, 129
 Security 129
 Security cable installation point 14
 Security menu 129
 Select Drive 86
 Serial connection 106
 Settings 137
 Settings menu 119
 Sharpness 116
 Signal menu 117
 Sleep Mode 134
 Sleep Mode Timer 134
 Slideshow 88
 SMTP Server 131
 SNMP 105, 132
 Soft carrying case 172
 Soft keyboard 125
 Sort Order 89
 Source Search 15, 18, 43, 104

- Speaker 13
 Specifications 178
 sRGB 54
 SSID 128
 SSID Auto Setting 128
 SSID Display 128
 Standby Mode 134
 Startup Screen 121
 Startup Source Search 121
 Status indicator 143
 Storage temperature 179
 Strap attachment hole 17
 Subnet Mask 128, 130
 Supported Monitor Displays 176
 Supported Resolutions 176
 S-Video Port 12
 Switching images 44
 SYNC IN/OUT port 13
 Sync Info 135
 Sync. 118
 System requirements 45
- T**
- Tele 15
 Temp indicator 143
 Theatre 54
 Tint 116
 Toolbars 121
 Tracking 118
 Trap IP address 132
- U**
- Uninstalling 47
- USB 18, 104
 USB cable 138
 USB Display 45
 USB Display/Easy Interactive Function . 122
 USB extension cable 172
 USB memory 136
 USB Storage 85
 USB Type B 122
 USB-A port 13
 USB-B port 13
 User 17
 User button 119
 User Pattern 96
 User's Logo 95, 121
 User's Logo Protection 98
- V**
- Version 135
 Video 16, 104
 Video Port 12
 Video Signal 135
 Video signal 118
 Volume 17, 53, 104, 119
- W**
- Wall mount 172
 Wall mount plate fixing points 14
 Web Control 102, 103
 Web Control Password 126
 Web Remote 103
 When projection starts 154
 Whiteboard Mode 61, 75
 Wide 15
- Wire lock 101
 Wired LAN Menu 130
 Wireless LAN menu 127
 Wireless LAN unit 36, 172
 Wireless LAN unit fixing screw 13
 Wireless Mode 124
 Wireless mouse function 93
 Wireless Mouse/USB Display 122
- Z**
- Zoom 119