

Pioneer Dj

MULTI PLAYER

CDJ-2000NXS2



<http://pioneerdj.com/support/>

The Pioneer DJ site shown above offers FAQs, information on software, and various other types of information and services to allow you to use your product in greater comfort.

<http://rekordbox.com/>

For various types of information and services regarding rekordbox™, see the Pioneer DJ website above.

<http://kuvo.com/>

Operating Instructions

Contents

How to read this manual

Thank you for buying this Pioneer DJ product.

Be sure to read both this manual and the Operating Instructions (Quick Start Guide). Both contain important information that you should understand before using this product.

In this document, names of screens, menus and touch keys displayed on the computer screen as well as the names of buttons and terminals on the product etc., are indicated within [] brackets.

Examples:

- Touch [LOOP MODE].
- Press the [CUE] button.
- The [UTILITY] screen is displayed.
- Click [All Programs] > [Pioneer] > [rekordbox 3.x.x] > [rekordbox 3.x.x] from the Windows [Start] menu.
- Connect the LAN cable properly to the [LINK] terminal.

01 Before start

Features	3
----------------	---

02 Before you start

Supported sources	5
Usable media	5
Playable music file formats	7
Preparing the software	8

03 Connections

Descriptions of terminals	9
Basic style	9
Using the DJ software	12

04 Part names and functions

Control panel	13
Rear panel	16
Front panel	16
Main unit display	17
Jog dial display section	18

05 Basic Operation

Turning the power on	19
Turning the power off	19
Loading and ejecting discs	19
Inserting and ejecting SD memory cards	19
Connecting and disconnecting USB devices	20
Playback	20
Operating the jog dial	22
Adjusting the playback and stopping speeds	22

06 Advanced Operation

Setting Cue	23
Setting loops	23
Setting Hot Cue	24
Storing cue or loop points	26
Deleting stored cue or loop points	26
Setting the cue point for auto cueing	26
Using beat jump/loop move	26
Using the slip mode	27
Playing from the touched position on the waveform display	28
Using the beat sync function	28
Adjusting the beat grid	28
Operating the CDJ-2000NXS2 in combination with other devices	29
Browsing tracks	29
Other browsing operations	30
Using hot cue banks	31
Checking the playing history (HISTORY)	31
Editing tag lists	31
Displaying the details of the currently loaded track	33
Changing track ratings	33
Displaying details of tracks loaded in other DJ players	33

07 Changing the settings

Storing the settings on a storage device (SD, USB)	34
Calling out settings stored on a storage device (SD, USB)	34
Changing the color set in a storage device (SD, USB)	34
Displaying the [UTILITY] screen	34
Changing the settings	34
Duplicating the settings onto DJ players connected by PRO DJ LINK	36

08 Using the DJ software

Operating the DJ software	37
---------------------------------	----

09 Additional information

Troubleshooting	39
About the liquid crystal display	40
Cleaning the touch display	40
Error messages	40
List of icons displayed on the main unit display section	41
About iPods/iPhones/iPads	41
Cautions on use	42
Handling discs	42
About trademarks and registered trademarks	43
Apple Lossless Audio Codec	43
FLAC	43

Before start

Features

This unit is a multi player for professional DJs, offering the variety of functions, durability and operability required for working in discos and nightclubs. Full-fledged DJ performances can be made using tracks not only on USB devices and computers but also on mobile devices (smart-phones, etc.). It is not only equipped with a wide range of features for DJ performances, including the PRO DJ LINK, WAVE and BEAT SYNC functions, it also has a high sound quality, high reliability design and panel layout providing high operability, thereby offering strong support for all types of DJ performances.

MULTI MEDIA, MULTI FORMAT

Music files stored on USB devices (flash memory devices or hard disks), SD memory cards, mobile devices, computers and discs (CD or DVD) can be played. The supported music file formats are MP3, AAC, WAV, AIFF, FLAC, ALAC and music CD (CD-DA). The music management software rekordbox can be used to carefully prepare the play lists, cues, loops and beat grids you will need for DJ performances at home. You can devote your attention to the DJ performance at the disco/club easily. This makes for a deejaying cycle smoothly integrating all the steps, from acquiring the music files to the actual DJ performance.

rekordbox (Mac/Windows)

rekordbox is a composite software that enables track management and DJ performances.

Music files on computers can be managed (analysis, setting, creation, history storage) with the music management software rekordbox (Mac/Windows) that can be downloaded for free.

An excellent DJ performance can be achieved by using the music files managed by rekordbox (Mac/Windows) together with this unit.

- In these operating instructions, the version of rekordbox for Mac/Windows is referred to as "rekordbox (Mac/Windows)". "rekordbox" is used to indicate the versions of rekordbox (Mac/Windows) and rekordbox (iOS/Android) simultaneously, as well as when referring to rekordbox functions directly.

rekordbox (iOS/Android)

rekordbox (iOS/Android), a smartphone application that can be downloaded free of charge, can be used for the management (analysis, settings, creation, history storage) of music files on mobile devices. Using music files managed with rekordbox (iOS/Android) in combination with this unit makes it possible to achieve outstanding DJ performances.

- In this manual, the mobile device edition of rekordbox is referred to as "rekordbox (iOS/Android)".

PRO DJ LINK

Two types of PRO DJ LINK functions are provided: "SD & USB Export" using an SD memory card or USB device (flash memory device or hard disk) and "rekordbox LINK Export" using a computer on which rekordbox is installed.

❖ SD & USB Export

rekordbox music files and management data can be exchanged using an SD memory card or a USB device. This eliminates the need to take the computer to discos or clubs.

At home or in a studio



- Add music files to collections and analyze them.
- Make the preparations on rekordbox.



Export the rekordbox data on a storage device (SD, USB).



At the disco or club

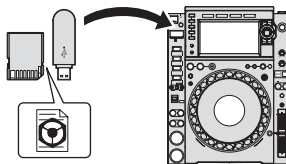

Connect the storage device (SD, USB) to the DJ player.

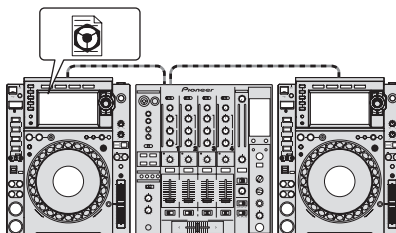

- Use the rekordbox data for the performance.
- Share the rekordbox data using the PRO DJ LINK function.



The playback history is stored on the storage device (SD, USB).



At home or in a studio

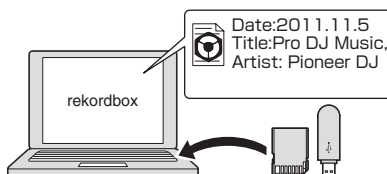

Check and manage the playback history with rekordbox.

❖ rekordbox LINK Export

When this unit and a computer are connected with a USB or LAN cable, rekordbox music files and management data can be exchanged directly. This eliminates the need to export the data to an SD memory card or a USB device.

At home or in a studio



- Add music files to collections and analyze them.
- Make the preparations on rekordbox.



At the disco or club

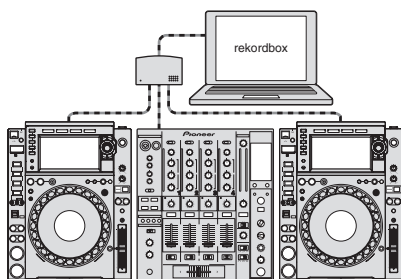

Connect the computer and DJ player.

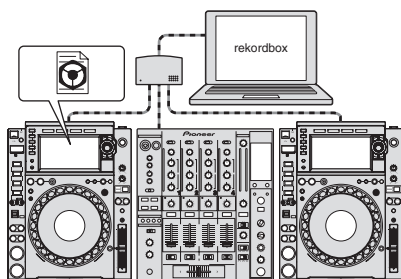

- Use the rekordbox data for the performance.
- Share the rekordbox data using the PRO DJ LINK function.



At home or in a studio

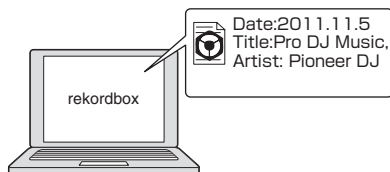

Check and manage the playback history with rekordbox.

TOUCH DISPLAY

This unit is equipped with a large, high-resolution full-color touch display making the information required for music file browsing or DJ performances easy to see.

❖ BROWSE

A large color LCD is equipped. It can display not only text data but also jacket photos. The combination of a GUI displaying music file information in easily understandable fashion and a rotary selector with easy operation enables to select tracks with no stress.

❖ TRACK FILTER

Tracks can be searched for by the tag information added to tracks using rekordbox or the information such as BPM and KEY. You can quickly find the tracks that match the specified condition.

❖ NEEDLE SEARCH

Just touch the overall waveform (WAVE) with your finger to instantly play the tune next to the touched one. A quick point search can be done by instinctive operation.

❖ WAVE/WAVE ZOOM

The high-resolution overall waveform ("WAVE") can be displayed so that you can grasp the overall composition of the track visually. Also, the frequency bands are color-coded, and a zoomable enlarged waveform ("WAVE ZOOM") can be displayed so that the development of the track can be grasped instantaneously.

MY SETTINGS

The function settings of this unit can be stored on SD memory cards, USB devices or mobile devices and loaded back onto this unit when necessary. It is also possible to make this unit's settings with rekordbox, then transfer them directly to this unit. This enables to quickly switch to the settings you have prepared in advance when replacing another DJ in a club.

BEAT SYNC

Based on the GRID information of tracks analyzed with rekordbox, the tempo (BPM) and beat position of tracks playing on this unit can automatically synchronize with other DJ players connected by PRO DJ LINK. The beat sync function helps you mix tracks and create mixing and effect performances, greatly expanding the range of DJ performances.

HIGH SOUND QUALITY

The CDJ-2000NXS2 is designed for thorough improvement of the sound quality, for both the digital and analog outputs.

For the digital circuitry, playback and transfer of the 96 kHz/24 bit high resolution audio is supported. This unit can faithfully reproduce even the most delicate sounds of the high resolution audio, achieving clear, high quality sound with a rich sense of mass and acoustic field. For the analog circuitry, this unit is equipped with a 32-bit high-performance D/A converter that reduces undesirable noise and distortion in wide frequency bands to the utmost limits by a single analog power supply, achieving clear, highly transparent sound faithful to the original.

SOUND CARD

This unit is equipped with a dedicated interface for controlling the DJ software and a MIDI interface. It also has a built-in sound card, allowing simple connections to other devices.

KUVO

KUVO is a service helping people to enjoy the club culture both inside and outside clubs connecting clubbers, DJs and clubs using the concept of "creating the next generation space to enjoy dance music".

See here for the service details.

<http://kuvo.com/>

Before you start

Supported sources







This unit supports the sources listed below.

- Disc (p.5)
- SD memory card (p.6)
- USB device (p.6)
- Computer (p.21)

Usable media

About discs

This unit can play the discs shown below.

Type	Mark ¹	Compatible formats	Supported file systems
CD		<ul style="list-style-type: none"> • Music CD (CD-DA) 	—
CD-R		<ul style="list-style-type: none"> • Music CD (CD-DA) • CD-ROM 	ISO9660 level 1, ISO9660 level 2, Romeo and Joliet
CD-RW			
CD-TEXT ²		Music CD (CD-DA)	—
DVD-R DVD-R DL (dual layer)			
DVD-RW		DVD-ROM	ISO9660 level 1, ISO9660 level 2, Romeo and Joliet
DVD+R DVD+R DL (dual layer)			
DVD+RW			

¹ Discs on which the marks on this table are indicated on the disc label, package or jacket can be played.

² Titles, album names and artist names recorded in the CD-Text data are displayed. When multiple text data are recorded on the disc, the information for the first text data is displayed.

❖ Discs that cannot be played

- DTS-CD
- Photo CDs
- Video CDs
- CD Graphics (CD-G) discs
- Unfinalized CDs
- DVD-Video discs
- DVD-Audio discs
- DVD-RAM discs
- Unfinalized DVDs

❖ About CD-R/-RW discs

Music files recorded on CD-R/-RW discs can be played.

Folder layers	Max. 8 layers (files in folders beyond the 8th layer cannot be played)
Max. number of folders	2 000 folders
Max. number of files	3 000 files

When there are many folders or files, some time may be required for loading.

❖ Playback of discs created on a computer or DVD recorder

Depending on the application's settings and the computer's environment settings, it may not be possible to play discs created on a computer. Record discs in a format playable on this unit. For details, contact your application's selling agent.

It may not be possible to play discs created on a computer or DVD recorder due to the disc's properties, scratches or dirt, or poor recording quality (dirt on the recording lens, etc.).

See *Handling discs* on page 42 for instructions on handling discs.

❖ Creating backup discs

When CD-R/-RW, DVD-R/-RW, DVD+R/+RW, DVD-R DL (dual layer) and DVD+R DL (dual layer) discs are paused or left in the pause mode at cue points for long periods of time, it may become difficult to play the disc that point, due to the properties of the disc. When a specific point is looped repeatedly an extremely large number of times, it may become difficult to play that point.

When playing valuable discs, we recommend making backup discs.

❖ Regarding copy protected CDs

This unit is designed to CD standards. Operation and performance of discs with standards other than CD standards is not guaranteed.

❖ About playing DualDiscs

A DualDisc is a new two-sided disc, one side of which contains DVD content — video, audio, etc. — while the other side contains non-DVD content such as digital audio material.

The non-DVD, audio side of the disc is not compatible with this player. For more detailed information on the DualDisc specification, please refer to the disc manufacturer or disc retailer.

❖ About 8 cm discs

8 cm discs cannot be played. Do not mount 8 cm adapters on discs and play the discs on this unit. The adapter could come off while the disc is rotating, damaging both the disc and this unit.

About SD memory cards

This unit can play music files recorded on SD memory cards conforming to SD standards can be played.

In this manual, "SD memory card" collectively refers to SD memory cards, SDHC memory cards, mini-SD memory cards mounted in SD memory card adapters and micro-SD memory cards mounted in SD memory card adapters.

Folder layers	Max. 8 layers (files in folders beyond the 8th layer cannot be played)
Max. number of folders	Unlimited (folders beyond the 10 000th folder within a single folder cannot be displayed)
Max. number of files	Unlimited (files beyond the 10 000th file within a single folder cannot be displayed)
Supported cards ^[1]	<ul style="list-style-type: none">SD memory cards: 8 MB – 2 GBSDHC memory cards: 4 GB – 32 GB
Compatible formats	<ul style="list-style-type: none">SD memory cards: FAT12 and FAT16 (conforming to SD standards)SDHC memory cards: FAT32 (conforming to SD standards)

[1] CPRM is not supported.

- If an SD memory card not formatted in one of the above compatible formats is inserted, [FORMAT SD] is displayed and the card cannot be used. Re-format the card on a computer, etc., before using it.
- Pioneer DJ does not guarantee that all SD memory cards will operate on this unit.

❖ Cautions on using SD memory cards

- SD memory cards are precision electronic devices. Handle them with care. Bending, dropping or subjecting SD memory cards to strong forces or shocks could break them. Also, do not use or store SD memory cards in environments where static electricity or electric noise tends to be produced. We recommend periodically making copies of valuable data.
- Please note that Pioneer DJ will accept no responsibility whatsoever for loss of data recorded by the customer on SD memory cards or other direct or indirect problems resulting from connection to this unit.
- After ejecting SD memory cards, store them in their dedicated case, etc.
- Depending on the SD memory card you are using, the desired performance may not be achieved.

About USB devices

This unit can play music files recorded on USB mass storage class USB devices (external hard disks, portable flash memory devices, etc.).

Folder layers	Max. 8 layers (files in folders beyond the 8th layer cannot be played)
Max. number of folders	Unlimited (folders beyond the 10 000th folder within a single folder cannot be displayed)
Max. number of files	Unlimited (files beyond the 10 000th file within a single folder cannot be displayed)
Supported file systems	FAT16, FAT32 and HFS+ (NTFS is not supported.)

Tracks managed by rekordbox can be played by connecting the mobile device on which rekordbox (iOS/Android) is installed via USB. For supported devices, see the Pioneer DJ support site (<http://pioneerdj.com/support/>). For rekordbox (iOS/Android), see the rekordbox online support site (<http://www.rekordbox.com>).

When there are many folders or files, some time may be required for loading.

Folders and files exceeding the limits cannot be displayed.

❖ USB devices that cannot be used

- Optical disc type devices such as external DVD/CD drives, etc., are not supported.
- USB hubs cannot be used.
- iPods cannot be used. (Music data on an iPad, iPod touch or iPhone can only be played on this unit if it is added to the rekordbox (iOS/Android) library.)

❖ Cautions on using USB devices

- Some USB devices may not operate properly. Please note that Pioneer DJ will accept no responsibility whatsoever for loss of data stored by the user on USB devices or other direct or indirect problems arising due to connection of USB devices to this unit.
- When the current above the permissible level is passed through the USB device insertion slot of this unit, the USB indicator will flash. The communication may be stopped by stopping the power supply to the USB device. To return to normal conditions, please remove the USB device connected to this unit. Avoid re-using the USB device for which the excess current has been detected. If you cannot return to the normal condition (cannot communicate) using the above-mentioned procedure, turn off the power supply unit once and then turn the power on again.
- If multiple partitions are set on the USB device, only the first partition can be used. (When rekordbox library information is present, the partition containing the rekordbox library information has priority.)
- USB devices equipped with flash card readers may not operate.
- Depending on the USB device you are using, the desired performance may not be achieved.

Playable music file formats

- This unit supports music files in the formats shown below.
- WAV (88.2 kHz, 96 kHz), AIFF (88.2 kHz, 96 kHz), Apple Lossless and FLAC files on discs cannot be played.
- Some files cannot be played with this unit even if the files are in the formats supported by this unit.

Type	File extension	Compatible formats	Bit depth	Bit rate	Sampling frequency	Encoding method
MP3	.mp3	MPEG-1 AUDIO LAYER-3	16 bit	32 kbps to 320 kbps	32 kHz, 44.1 kHz, 48 kHz	CBR, VBR
		MPEG-2 AUDIO LAYER-3	16 bit	8 kbps to 160 kbps	16 kHz, 22.05 kHz, 24 kHz	CBR, VBR
AAC	.m4a, .aac and .mp4	MPEG-4 AAC LC	16 bit	16 kbps to 320 kbps	16 kHz, 22.05 kHz, 24 kHz, 32 kHz, 44.1 kHz, 48 kHz	CBR, VBR
		MPEG-2 AAC LC	16 bit	16 kbps to 320 kbps	16 kHz, 22.05 kHz, 24 kHz, 32 kHz, 44.1 kHz, 48 kHz	CBR, VBR
WAV	.wav	WAV	16 bit, 24 bit	—	44.1 kHz, 48 kHz, 88.2 kHz, 96 kHz	Uncompressed PCM
AIFF	.aif, .aiff	AIFF	16 bit, 24 bit	—	44.1 kHz, 48 kHz, 88.2 kHz, 96 kHz	Uncompressed PCM
Apple Lossless	.m4a	ALAC	16 bit, 24 bit	—	44.1 kHz, 48 kHz, 88.2 kHz, 96 kHz	Lossless compression
FLAC	.flac, .fla	FLAC	16 bit, 24 bit	—	44.1 kHz, 48 kHz, 88.2 kHz, 96 kHz	Lossless compression

About MP3 files

MP3 files can have a constant bit rate (CBR) or a variable bit rate (VBR). Both types of files can be played on this unit, but the search and super fast search functions are slower with VBR files. If your priority is operability, we recommend recording MP3 files in CBR.

About AAC files

- AAC is the abbreviation of "Advanced Audio Coding", a basic format of audio compression technology used for MPEG-2 and MPEG-4.
- The file format and extension of AAC data depends on the application used to create the data.
- On this unit, in addition to AAC files encoded with iTunes® and with the extension ".m4a", files with the extensions ".aac" and ".mp4" files can also be played. However, AAC files that are copyright-protected, such as those purchased from the iTunes Store, cannot be played. Also, depending on the version of iTunes in which the file was encoded, it may not be possible to play the file.

About ID3 tags

The tag information types which can be registered from a music file are ID3 tags (v1, v1.1, v2.2.0, v2.3.0, and v2.4.0) or meta tags.

About music file artwork

The file format for artwork images that can be added to music files is JPEG (extensions: ".jpg" or ".jpeg").

- Files larger than 800 x 800 dots cannot be displayed.

About character displays

❖ CD-TEXT

This unit is compatible with CD-TEXT. Titles, album names and artist names recorded in CD-TEXT are displayed. When multiple text data is recorded, the first text data is displayed. The supported character codes are listed below.

- ASCII
- ISO-8859
- MS-JIS
- Mandarin Chinese character code

❖ Music files

When displaying track names, etc., to display characters written in local codes other than Unicode, change the [LANGUAGE] setting.

- ➡ *Changing the language* (p.36)

Preparing the software

Music management software rekordbox and driver software are not included.

To use rekordbox and the driver software, access the rekordbox site and Pioneer DJ Support site, and download the software.

- The user is responsible for preparing the computer, network devices and other elements of the Internet usage environment required for a connection to the Internet.

About rekordbox

rekordbox is a composite software that enables track management and DJ performances.

An excellent DJ performance can be achieved by using the music files managed by rekordbox together with this unit.

❖ Obtaining rekordbox (Mac/Windows)

1 Open your web browser on your computer, and access the rekordbox site.

<http://www.rekordbox.com>

2 Click [Download] in the rekordbox site and download rekordbox from the download page.

For inquiries on rekordbox (Mac/Windows), see the support site indicated above.

❖ About rekordbox (iOS/Android)

Tracks managed by rekordbox can be played by connecting the mobile device on which rekordbox (iOS/Android) is installed via USB. For supported devices, see the Pioneer DJ support site (<http://pioneerdj.com/support/>).

- For details on installing rekordbox (iOS/Android), see the Pioneer DJ website (<http://www.rekordbox.com>).

Cautions on copyrights

rekordbox restricts playback and duplication of copyright-protected music contents.

- When coded data, etc., for protecting the copyright is embedded in the music contents, it may not be possible to operate the program normally.
- When rekordbox detects that coded data, etc., for protecting the copyright is embedded in the music contents, processing (playback, reading, etc.) may stop.

Recordings you have made are for your personal enjoyment and according to copyright laws may not be used without the consent of the copyright holder.

- Music recorded from CDs, etc., is protected by the copyright laws of individual countries and by international treaties. It is the full responsibility of the person who has recorded the music to ensure that it is used legally.
- When handling music downloaded from the Internet, etc., it is the full responsibility of the person who has downloaded the music to ensure that it is used in accordance with the contract concluded with the download site.

Using the online support site

Before making inquiries on rekordbox operating procedures or technical issues, read the rekordbox (Mac/Windows) user's manual and online manual and check the FAQ provided on the rekordbox online support site.

<rekordbox online support site>

<http://www.rekordbox.com>

About the driver software

❖ Audio driver software (Windows)

- This driver software is an exclusive ASIO driver for outputting audio signals from the computer.
- There is no need to install the driver software when using Mac OS X.

❖ USB (LINK Export) connections driver software for rekordbox (Mac/Windows)

- The driver software is a dedicated driver for connecting this unit and rekordbox (Mac/Windows) via USB (LINK Export).

❖ Obtaining the driver software

1 Launch a web browser on the computer and access the Pioneer DJ support site below.

<http://pioneerdj.com/support/>

2 Click [Software Download] under [CDJ-2000NXS2] on the Pioneer DJ support site.

3 Click the icon of the driver software to download the driver software from the download page.

- For information on installing the driver software, see the Pioneer DJ support site.

Connections

- Be sure to turn off the power and unplug the power cord from the power outlet whenever making or changing connections.
- Refer to the operating instructions for the component to be connected.
- Connect the power cord after all the connections between devices have been completed.

- When using a LAN cable for connection, be sure to use either the LAN cable included with this product or an STP (shielded twisted pair) cable.
- Do not disconnect the LAN cable when music files and/or information are being shared using PRO DJ LINK.

Descriptions of terminals

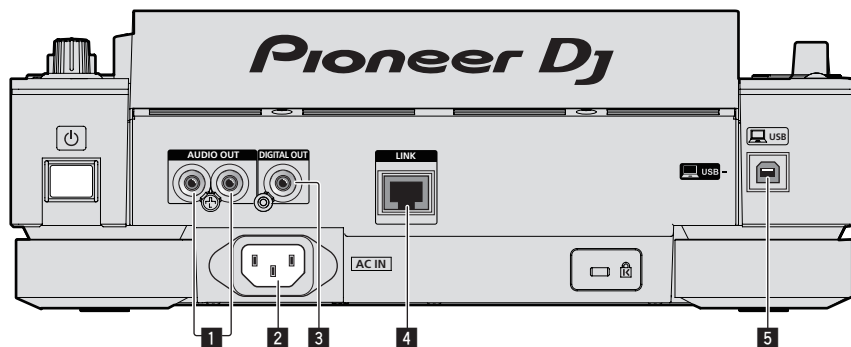

1 AUDIO OUT L/R terminals

Connect the audio cables (included) here.

2 AC IN

Connect this to a power outlet.
Connect the power cord after all the connections between devices have been completed.
Be sure to use the included power cord.

3 DIGITAL OUT terminal

Connect a digital audio cable here.

4 LINK terminal

Connect the LAN cable (included) here.

5 USB port

Connect to a computer.

Basic style

Playback on this unit is performed mainly using tracks prepared with rekordbox installed on a computer.

- For instructions on operating rekordbox, see the rekordbox (Mac/Windows) user's manual. The rekordbox (Mac/Windows) user's manual can be viewed from the [Help] menu of rekordbox (Mac/Windows).
- Also, for DJ players and DJ mixers, up to four PRO DJ LINK-compatible players can be connected with LAN cables (CAT5e) using PRO DJ LINK connections.
- A switching hub (commercially available) may be necessary, depending on the combination of models used. Use a switching hub of 100 Mbps or greater. Some switching hubs may not operate properly.
- A switching hub (commercially available) is necessary to connect to a mixer equipped with only one LAN port. For mixers with enough LAN ports for all the DJ players and computers in the system, connect directly to the LAN ports on the mixer's rear panel, without using a hub.
- Use a wireless router (commercially available) and access point (commercially available) conforming to either IEEE802.11n or IEEE802.11ac. Depending on the signal conditions in the usage environment and the wireless router or access point, PRO DJ LINK connections may not operate properly.

Connecting to a mixer with only one LAN port

When connecting to a mixer with only one LAN port using a switching hub, for optimum usage of rekordbox's music file management functions, set the channel number of the mixer to which the audio or digital audio cable is connected and the player number displayed at the bottom left of the main unit display to the same number.

(Ex.: When the audio cable is connected to channel 1)

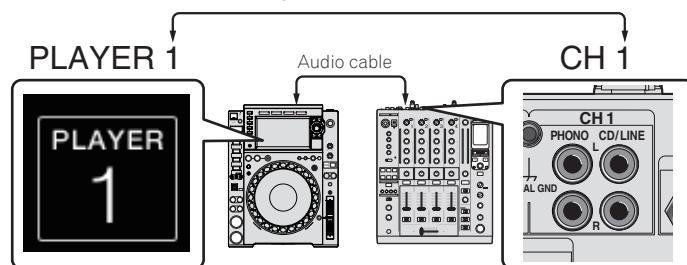

To change the player number, follow the procedure below.

- ① Disconnect the storage device (SD, USB) and LAN cable.
- ② Press the [MENU/UTILITY] button for over 1 second to display the [UTILITY] screen.
- ③ Turn the rotary selector to select [PLAYER No.], then press the rotary selector.
- ④ Turn the rotary selector to select the player number, then press the rotary selector to enter it.

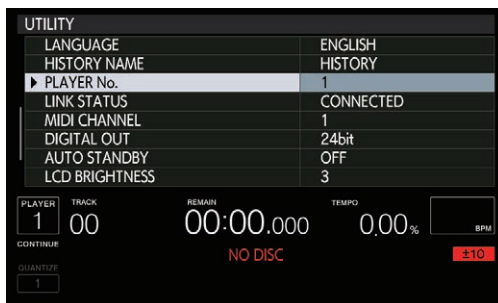

- ⑤ Press the [MENU/UTILITY] button to complete the setting.

PRO DJ LINK (SD & USB Export)

- rekordbox music files and data can be exchanged with this unit using a memory device (flash memory, hard disk, etc.), eliminating the need to take a computer into the DJ booth. Such information as playlists, cues, loops and hot cues set in advance with rekordbox can be used for playback.

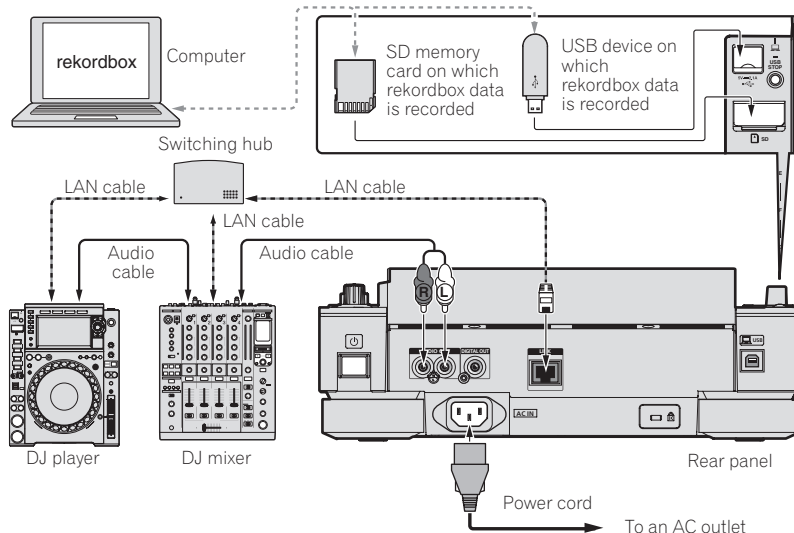

PRO DJ LINK (LINK Export)

- When a computer on which rekordbox is installed is taken into the DJ booth and connected to this unit using a LAN cable (CAT5e), USB cable or wireless LAN (Wi-Fi) router, tracks in rekordbox can be selected and played. This makes it possible to use the information such as playlists, cues, loops and hot cues that have been set ahead of time with rekordbox.
- Tracks in rekordbox can be selected and played when connected to a mobile device on which rekordbox (iOS/Android) is installed by USB cable or wireless LAN (Wi-Fi) router. Performances can be held using such information as playlists, cues, loops and hot cues that have been set ahead of time with rekordbox.
- With wired LAN or USB (LINK Export) connections, up to two computers on which rekordbox (Mac/Windows) is installed can be connected.
- With wireless LAN (Wi-Fi) connections, up to four computers or mobile devices on which rekordbox is installed can be connected.

iPods/iPhones/iPads that can be connected to this product

- This product supports iPhone 6s Plus, iPhone 6s, iPhone 6 Plus, iPhone 6, iPhone 5s, iPhone 5c, iPhone 5, iPhone 4s, iPad Pro, iPad mini4, iPad Air2, iPad mini3, iPad Air, iPad mini2, iPad mini, iPad (3rd and 4th generation), iPad2 and iPod touch (5th and 6th generation).
- For the latest supported devices, see the Pioneer DJ website (<http://pioneerdj.com/support/>).

❖ Using a switching hub

LAN connections

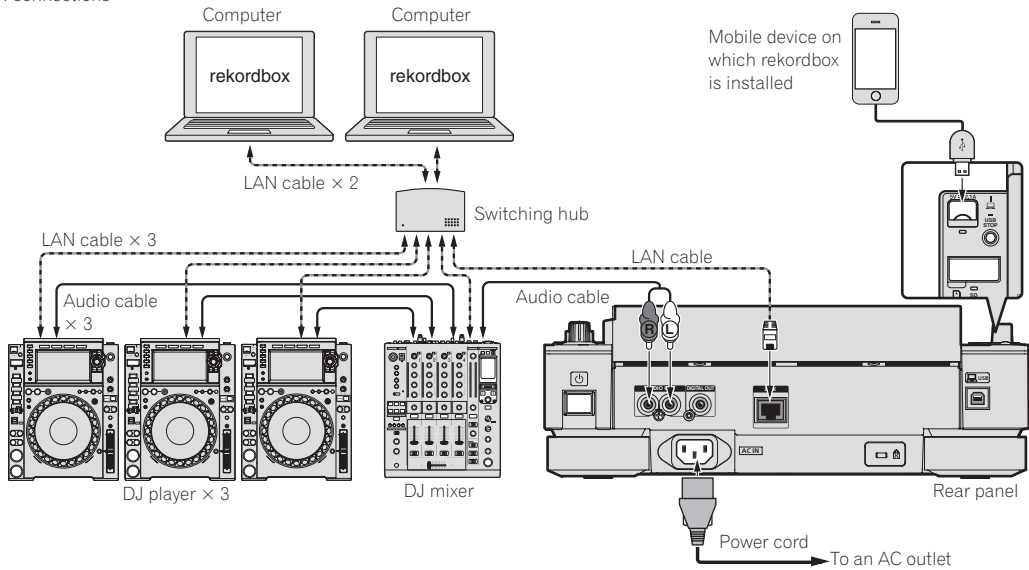

USB (LINK Export) connections

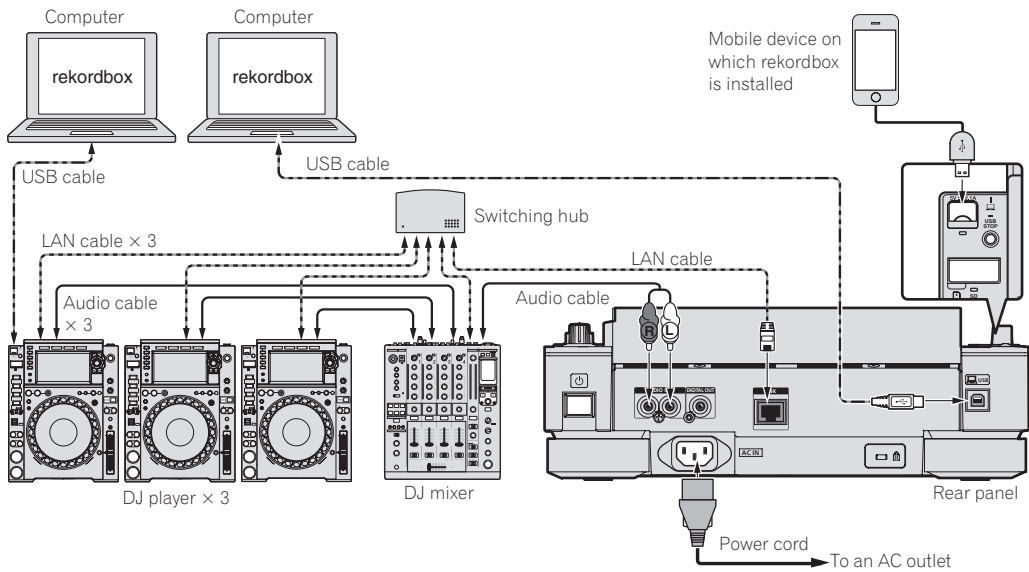

- Use your cable to connect this unit with an iPod, iPhone or iPad.
- A switching hub (commercially available) is necessary to connect to a mixer equipped with only one LAN port. For mixers with enough LAN ports for all the DJ players and computers in the system, connect directly to the LAN ports on the mixer's rear panel, without using a hub.
- Install the driver software before connecting a computer on which rekordbox (Mac/Windows) is installed via USB. For details, see *About the driver software* on page 8.

❖ Using a wireless router and access points

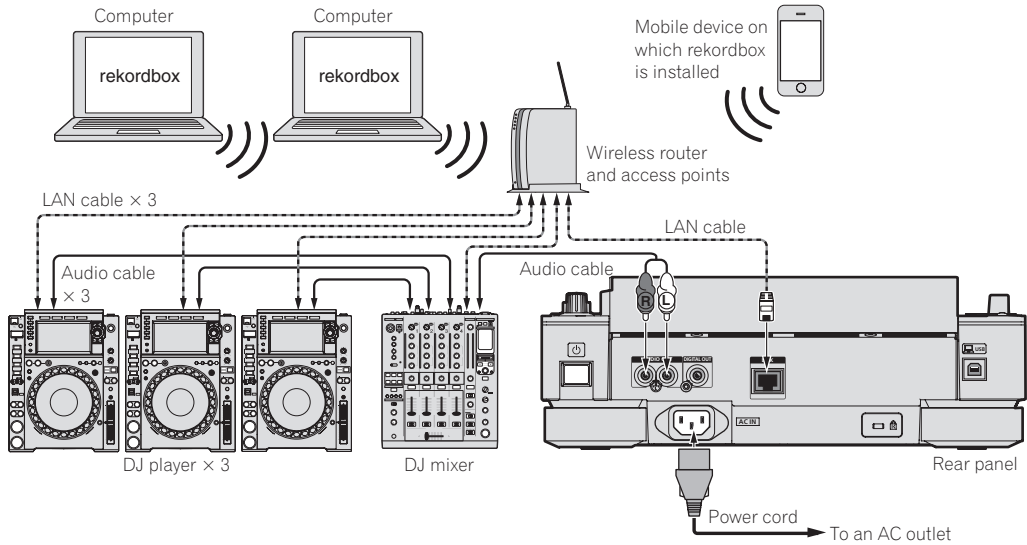

Cautions

To use rekordbox's music file management functions to their maximum, set the channel of the audio or digital audio cable connected to the mixer and the player number to the same number.

If the player number is different, change the [PLAYER No.] setting on the [UTILITY] screen.

- When a storage device is connected to this unit, [PLAYER No.] is displayed in gray and cannot be changed. Disconnect the storage device or LAN cable to turn the link off, then change the setting.

Using the DJ software

This unit outputs the operation information of buttons, tempo adjustment dial, etc. in universal MIDI or HID format. When connected by a USB cable to a computer on which a MIDI- or HID-compatible DJ software is installed, the DJ software can be operated from this unit. The sound of the music file that is playing on the computer can be output from this unit. For details, see *About the driver software* on page 8 and *Using the DJ software* on page 37.

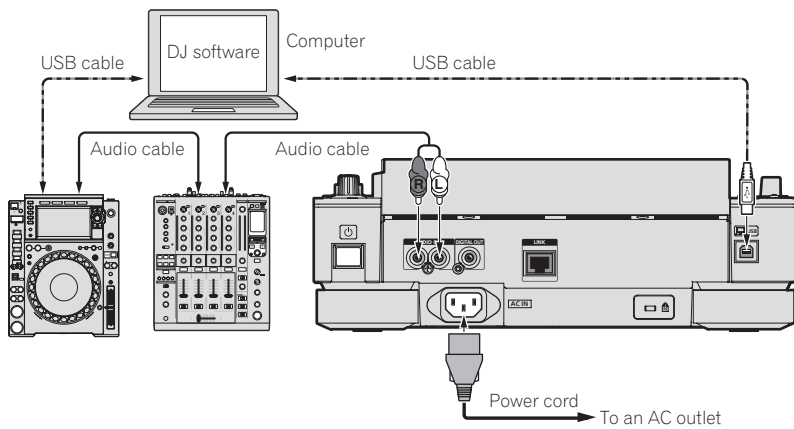

Part names and functions

Control panel

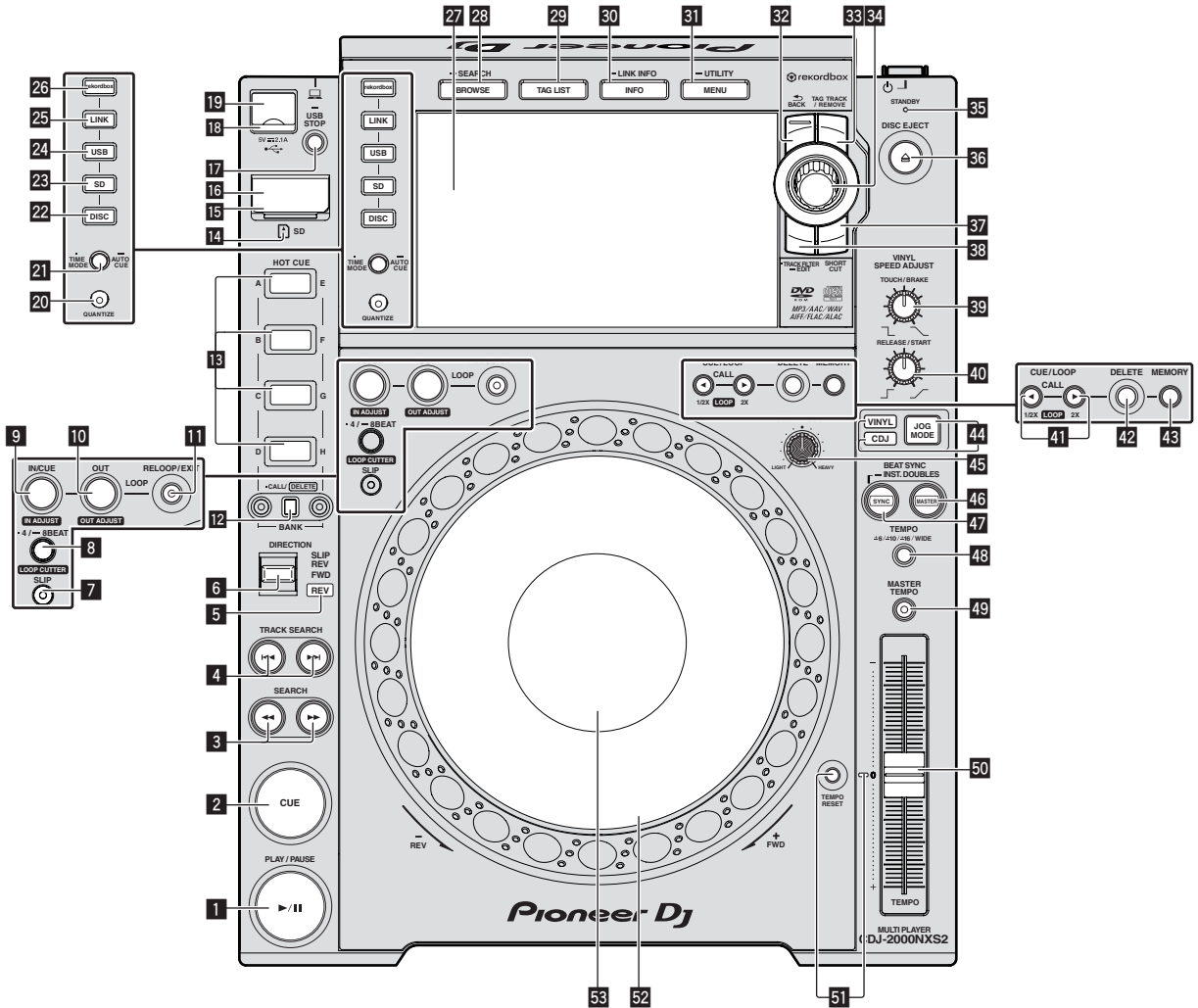

1 PLAY/PAUSE ►/|| button

This lights when playing tracks and flashes when in the pause mode.
 ➔ *Pausing* (p.21)

2 CUE button

This lights when a cue point is set (except during track searching), and flashes when a new cue point can be set in the pause mode.
 ➔ *Setting a Cue* (p.23)

3 SEARCH ◀◀, ▶▶ buttons

The track is forwarded/reversed while the button is held in.
 ➔ *Forward and reverse scanning* (p.21)

4 TRACK SEARCH ◀◀◀, ▶▶▶ buttons

Use these to search for the beginnings of tracks.
 ➔ *Finding the beginnings of tracks (Track Search)* (p.21)

5 REV indicator

This lights when playing in the reverse direction.
 ➔ *Playing in reverse* (p.22)

6 DIRECTION FWD/REV/SLIP REV lever

Use this to turn reverse playback on and off.
 ➔ *Playing in reverse* (p.22)
 Use this to turn the slip reverse mode on and off.
 ➔ *Using the slip mode* (p.27)

7 SLIP button

➔ *Using the slip mode* (p.27)

8 4/8BEAT (LOOP CUTTER) button

➔ *Setting loops automatically (4-beat Loop)* (p.24)

9 IN/CUE (IN ADJUST) button

Use this to set and fine-adjust the loop in point.
 ➔ *Setting loops* (p.23)

10 LOOP OUT (OUT ADJUST) button

Use this to set and fine-adjust the loop out point.
 ➔ *Setting loops* (p.23)

11 RELOOP/EXIT button

Use this to return to loop playback (reloop) or cancel loop playback (loop exit).
 ➔ *Returning to Loop playback (Reloop)* (p.24)

12 HOT CUE (A to H, CALL/DELETE) buttons

Use this to set, delete, play and call out hot cues.

☞ *Setting Hot Cue* (p.24)

13 HOT CUE BANK button

Use this to switch between **HOT CUE(A, B, C, D)** and **HOT CUE(E, F, G, H)**.

14 SD memory card indicator

This flashes when communicating with the SD memory card. The color of the SD memory card indicator changes to the color set in the SD memory card.

☞ *Changing the color set in a storage device (SD, USB)* (p.34)

15 SD memory card door

Open and close this door to insert or remove SD memory cards.

☞ *Inserting and ejecting SD memory cards* (p.19)

16 SD memory card insertion slot

Load SD memory cards here.

☞ *Inserting and ejecting SD memory cards* (p.19)

17 USB STOP button

Press for at least 2 seconds before disconnecting the USB device.

☞ *Connecting and disconnecting USB devices* (p.20)

18 USB indicator

This flashes when this unit is communicating with the USB device. The color of the USB indicator changes to the color set in the USB device.

☞ *Changing the color set in a storage device (SD, USB)* (p.34)

19 USB device insertion slot

Load the USB device here.

☞ *Connecting and disconnecting USB devices* (p.20)

20 TIME MODE/AUTO CUE button

When pressed once, the main unit display's time display mode (remaining time display or elapsed time display) switches. When pressed for over 1 second, auto cue turns on and off.

☞ *Setting auto cue* (p.23)

21 QUANTIZE button

Press this to use the quantize function.

When the quantize function is set to on, points are automatically set to the nearest beat position when setting loop in points, loop out points, hot cues and cues.

Also, the hot cue, loop, reverse and slip functions can be used without breaking the beat.

- When the quantize function is set to on, **[QUANTIZE]** and the **QUANTIZE** beat size are displayed on the main unit display.

☞ *Main unit display* (p.17)

The quantize function does not work in the following situations (**[QUANTIZE]** is displayed in gray):

- When playing tracks recorded on discs
- When playing music files that have not been analyzed with rekordbox

22 DISC button

Press this to play music files on CDs, CD-ROMs or DVD-ROMs.

☞ *Playing media connected to or inserted in this unit* (p.20)

23 SD button

Press this to play music files on the SD memory card.

☞ *Playing media connected to or inserted in this unit* (p.20)

24 USB button

Press this to play the music files on a USB device.

☞ *Playing media connected to or inserted in this unit* (p.20)

25 LINK button

Press this to play music files on storage device (SD, USB) loaded in other DJ players.

☞ *Playing storage devices (SD, USB) of other players and mobile devices on which rekordbox is installed* (p.20)

Press this to use DJ software for performances.

☞ *Using the DJ software* (p.12)

26 rekordbox button

Press this to play music files in rekordbox.

☞ *Playing the rekordbox library on a computer or mobile device* (p.21)

27 Main unit display

The screen switches to the normal playback screen when the **[BROWSE/SEARCH]**, **[TAG LIST]** and **[INFO/LINK INFO]** buttons are all turned off.

☞ *Main unit display* (p.17)

28 BROWSE/SEARCH button

Press this to display the **[BROWSE]** screen.

☞ *Switching to the browse screen* (p.29)

If you press **[BROWSE/SEARCH]** for over 1 second, the **[SEARCH]** screen appears.

☞ *Searching for tracks* (p.30)

29 TAG LIST button

Press this to display the **[TAG LIST]** screen.

☞ *Editing tag lists* (p.31)

30 INFO/LINK INFO button

Press this to display the **[INFO]** screen.

☞ *Displaying the details of the currently loaded track* (p.33)

31 MENU/UTILITY button

When pressed once, the menu screen is displayed.

The **[UTILITY]** screen is displayed when this is pressed for over 1 second.

☞ *Displaying the [UTILITY] screen* (p.34)

32 BACK button

Press this once to return to the previous screen.

Press for over 1 second to move to the top layer.

☞ *Playing media connected to or inserted in this unit* (p.20)

33 TAG TRACK/REMOVE button

Use these to add and remove tracks from the tag list.

☞ *Editing tag lists* (p.31)

34 Rotary selector

When selecting tracks or setting items, the cursor moves when the rotary selector is turned. Press the rotary selector to enter.

35 STANDBY indicator

This lights when in the standby mode.

☞ *Setting the auto standby mode* (p.35)

36 DISC EJECT button

Use this to eject discs.

☞ *Ejecting discs* (p.19)

37 SHORTCUT button

Press this to start the **TRACK**, **PLAYLIST** and **SEARCH** category screen on which the **PLAYER** settings can be configured.

38 TRACK FILTER/EDIT button

Tracks can be searched for by the tag information added to tracks using rekordbox or the information such as **BPM** and **KEY**.

☞ *Other browsing operations* (p.30)

39 VINYL SPEED ADJUST TOUCH/BRAKE control

This adjusts the speed at which playback stops when the top of the jog dial is pressed.

☞ *Adjusting the speed at which playback stops* (p.22)

40 VINYL SPEED ADJUST RELEASE/START control

This adjusts the speed at which playback returns to the normal speed when the top of the jog dial is released.

☞ *Adjusting the speed at which the normal playing speed is reached* (p.22)

41 CUE/LOOP CALL ◀(LOOP 1/2X), ▶(LOOP 2X) buttons

Use these to call out stored cue and loop points.

☞ *Calling out stored cue or loop points* (p.26)

When pressed during loop playback, the loop is cut or extended.

☞ *Cutting loops (Loop Cut)* (p.24)

☞ *Extending loops (loop doubling)* (p.24)

42 DELETE button

Use this to delete cue and loop points.

➔ *Deleting points individually* (p.26)

43 MEMORY button

Use this to store cue and loop points in the memory.

➔ *Storing cue or loop points* (p.26)

44 JOG MODE button, VINYL mode indicator and CDJ mode indicator

The mode switches between VINYL and CDJ each time this is pressed. The indicator for the selected mode lights.

➔ *Switching the jog dial mode* (p.22)

45 JOG ADJUST control

This adjusts the load applied when the jog dial is spun.

➔ *Adjusting the load when the jog dial is spun* (p.22)

46 BEAT SYNC MASTER button

Use this to set the track loaded in this unit as the master for the beat sync function.

➔ *Using the beat sync function* (p.28)

47 BEAT SYNC/INST.DOUBLE button

Use this to turn on the beat sync function.

➔ *Using the beat sync function* (p.28)

48 TEMPO ±6/±10/±16/WIDE button

Use this to switch the playing speed adjustment range.

➔ *Adjusting the playing speed (Tempo control)* (p.21)

49 MASTER TEMPO button

Use this to turn the master tempo function on and off.

➔ *Adjusting the playing speed without changing the pitch (Master Tempo)* (p.21)

50 TEMPO slider

Use this to adjust the track playing speed.

➔ *Adjusting the playing speed (Tempo control)* (p.21)

51 TEMPO RESET button and TEMPO RESET indicator

Use this to play the track at the original playing speed as recorded on the disc, etc., regardless of the position of the TEMPO slider. When the TEMPO RESET button is turned on, the indicator lights.

52 Jog dial (–REV/+FWD) and jog ring illumination

This can be used for such operations as scratching, pitch bending, etc.

➔ *Operating the jog dial* (p.22)

53 Jog dial display section

➔ *Jog dial display section* (p.18)

Rear panel

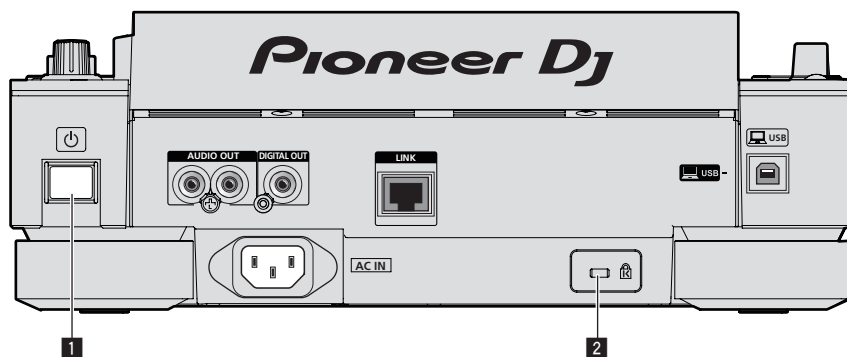

For the terminals used for connections, see *Descriptions of terminals* on page 9.

1 **switch**
Press to turn the power on and off.

2 **Kensington security slot**

Front panel

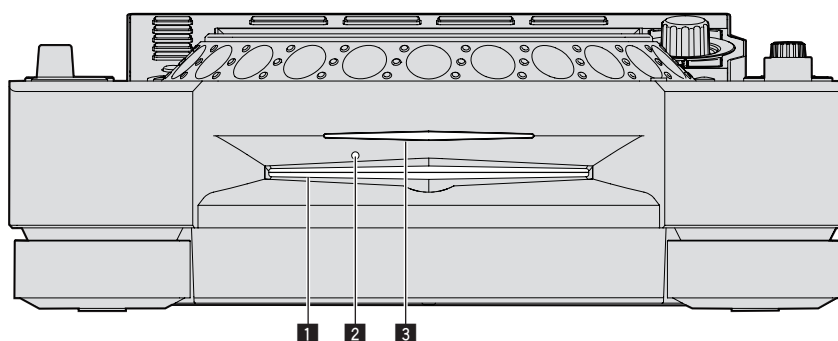

1 **Disc insertion slot**

2 **Disc force eject pin insertion hole**

3 **Disc insertion slot indicator**

About ejecting discs by force

- If the disc cannot be ejected by pressing the **[DISC EJECT▲]** button, the disc can be forcibly ejected by inserting the disc force eject pin into the disc force eject pin insertion hole on the main unit's front panel.
- When forcibly ejecting a disc, be sure to do so following the procedure below.

1 Press the switch to turn off this unit's power and wait for 1 minute or more.

Never forcibly eject a disc directly after turning off the set's power. Doing so is dangerous for the reasons described below. The disc will still be spinning when ejected and could hit your fingers, etc., causing injury. Also, the disc clamp will rotate in an unstable way, and the disc could get scratched.

2 Use the included disc force eject pin. (Do not use anything else.)

The included disc force eject pin is mounted on this unit's bottom panel. When the pin is inserted all the way into the insertion hole, the disc is ejected 5 mm to 10 mm out of the disc insertion slot. Grasp the disc with your fingers and pull it out.

Main unit display

Normal playback screen (display/touch keys)

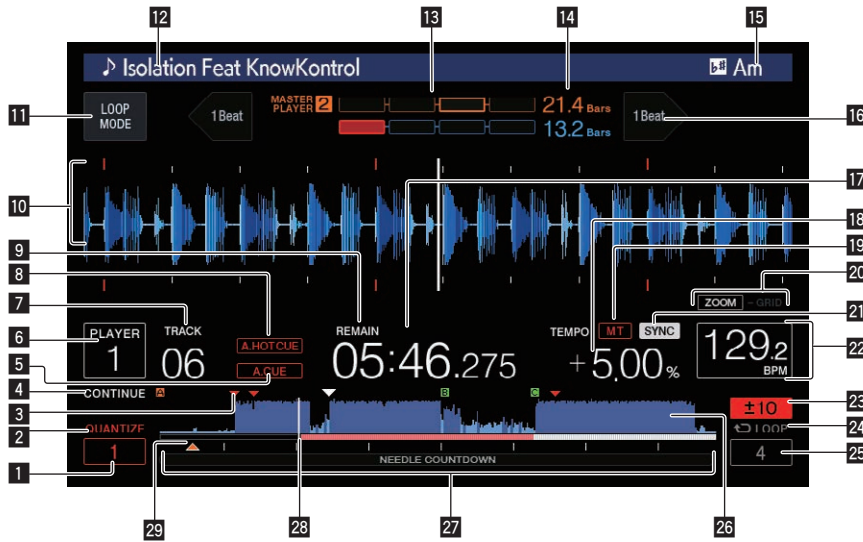

1 QUANTIZE BEAT VALUE

This indicates the **QUANTIZE** beat size.

2 QUANTIZE

This is displayed when **[QUANTIZE]** is on.

3 Cue/loop/hot cue point memory display

This displays the position of cue point, loop point and hot cue point recorded on the storage device (SD, USB) with the mark.

4 SINGLE/CONTINUE

Changes the way the tracks loaded in this unit are played.

5 A. CUE

This lights when auto cue is set.
➔ *Setting auto cue* (p.23)

6 PLAYER

This indicates the player number (1 – 4) assigned to this unit.

7 TRACK

This indicates the track number (01 – 999).

8 HOT CUE AUTO LOAD

This is displayed when **HOT CUE AUTO LOAD** is turned on.
➔ *Calling out hot cues* (p.25)

9 REMAIN

This lights when the time display is set to the remaining time.

10 Information display section

- The enlarged waveform analyzed with rekordbox, etc., is displayed here.
- The enlarged waveform color can be changed with rekordbox, or **[MENU]** or the **[SHORTCUT]** screen of the unit.
- ➔ *Changing the color set in a storage device (SD, USB)* (p.34)
 - If touching the waveform display during playback, the enlarged waveform of the touched point is displayed.

11 LOOP MODE

➔ *Setting the loop automatically based on the track's tempo (Auto Beat Loop)* (p.24)

12 Track names

You can set background color on rekordbox or this unit.
➔ *Changing the color set in a storage device (SD, USB)* (p.34)

13 PHASE METER

This indicates the amount of divergence of the bars and beats with the master player when using the beat sync function.
Touch this to switch the **[PHASE METER]** display. It can also be switched on the **[SHORTCUT]** screen.

14 BEAT COUNTDOWN

- This indicates the number of bars or beats from the currently playing position to the nearest stored cue point.
- If touching the waveform display during playback, the number of bars and beats from the current playing position to the touched point is displayed. The scale is displayed in 16-bar interval.

15 KEY

This indicates the track's key.

16 BEAT JUMP

This moves the playback position one beat forward or backward.
➔ *Using beat jump/loop move* (p.26)

17 Time display (minutes, seconds and msec)

This displays the remaining time or elapsed time.

18 Playing speed display

The value changes according to the position of the **[TEMPO]** slider.

19 MT

This lights when the master tempo is set.
➔ *Adjusting the playing speed without changing the pitch (Master Tempo)* (p.21)

20 ZOOM and GRID ADJUST mode display

When the rotary selector is pressed for over 1 second, the mode switches between the **[ZOOM]** mode and the **[GRID ADJUST]** mode.

- [ZOOM]** mode: The waveform zooms in or out when the rotary selector is turned.
- [GRID ADJUST]** mode: When the rotary selector is turned, the beat grid is adjusted.

The beat grid can be adjusted using the **[MENU/UTILITY]** button.
➔ *Adjusting the beat grid* (p.28)

21 SYNC

This is displayed when **[SYNC]** is turned on.

22 BPM

Displays BPM (Beats Per Minute) of the track currently being played.

- The BPM measured by this unit may differ from the BPM indicated on the disc or that of a Pioneer DJ's DJ mixer, etc. This is due to the different methods used for measuring the BPM, and is not a malfunction.

23 Playing speed adjustment range display

This indicates the range in which the playing speed can be adjusted with respect to the original playing speed recorded on the medium.

24 Loop display

This lights up during loop.

- ☞ *Setting loops* (p.23)

25 LOOP beat display

Beat count set in the loop is displayed.

26 Waveform display

This displays the sound as a waveform.

The overall waveform color can be changed with rekordbox, or [MENU] or the [SHORTCUT] screen of the unit.

- ☞ *Changing the color set in a storage device (SD, USB)* (p.34)

27 Playing address display/scale display (1-minute interval/16-bar interval)

The track is displayed as a bar graph. The current playback position is displayed as a white vertical line. When the elapsed time is displayed, the left edge of the graph lights. When the remaining time is displayed, the display turns off from the left side. The entire graph flashes slowly when there are less than 30 seconds remaining in the track, then begins flashing rapidly when less than 15 seconds remain.

28 Cache meter

This indicates how much of the currently playing track is cached in the memory.

29 Cue/loop/hot cue point display

This displays the position of cue point, loop point and hot cue point that have been set using the mark.

Jog dial display section

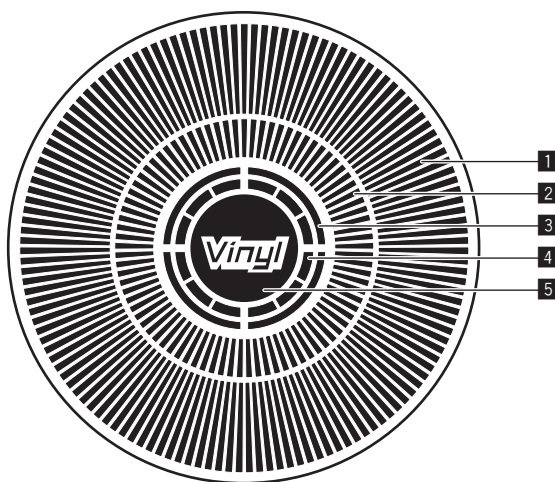

1 Operation display

This indicates the playing position, with one revolution equal to 135 frames. It turns during playback and stops in the pause mode.

2 Cue point display/slip play display

3 Audio memory status display

This flashes when the audio memory is being written. It stops flashing, remaining lit, when writing is completed.

It may not be possible to perform the real time cue operation while the audio memory is being written.

The display also flashes when there is not enough memory due to scratch play.

4 Jog touch detection display

When the jog mode is set to VINYL, the top of the jog dial lights when pressed.

5 VINYL

This lights when the jog mode is set to VINYL.

- ☞ *Operating the jog dial* (p.22)

Basic Operation

Turning the power on

1 Make all the connections, then plug the power cord into a power outlet.

➔ *Connections* (p.9)

2 Press the [⏻] switch.

This unit's indicators light and the power turns on.

Turning the power off

Press the [⏻] switch.

This unit's power turns off.

- Do not pull out the SD memory card or turn off this unit's power while the SD memory card indicator is flashing. Doing so could delete this unit's management data and damage the SD memory card, making it impossible to read.
- Do not remove the USB device or turn Off the power of the unit while the USB indicator is flashing. The management data in the unit may get deleted. Also, the USB device may become unreadable.

Loading and ejecting discs

- This unit is a one-disc player. Do not insert multiple disc.
- Do not force discs into the disc insertion slot when this unit's power is off. Doing so could damage the disc and lead to malfunction of this unit.
- When the disc is being drawn in or ejected, do not apply any force to the disc in the direction opposite its movement. Doing so could damage the disc or this unit.

Inserting discs

1 Press the [⏻] switch to turn this unit's power on.

2 Insert the disc horizontally into the disc insertion slot, with the printed surface facing up.

Playback starts after the medium's information has been read.

- When a disc containing music files recorded with a hierarchical structure is loaded, playback starts from the tracks in the uppermost layer.

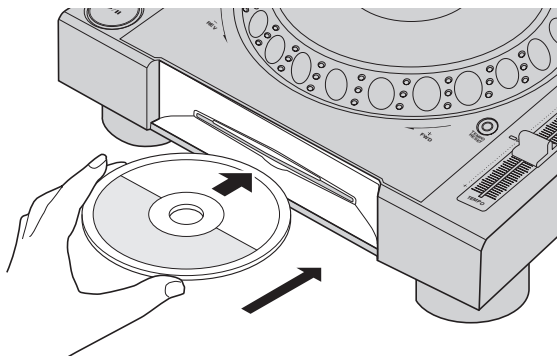

- When auto cue is turned on, the disc pauses at the audio start position. In this case, press the [▶/II] to start playback.
➔ For details on auto cue, see *Setting auto cue* on page 23.
- If a disc is inserted when a storage device (SD, USB) that has previously been connected to this unit or another Pioneer DJ's DJ player is connected, the number of discs including the disc information is displayed on the main unit display for a few seconds.
➔ For details on storing disc information, see *Procedure for calling out hot cues (for discs)* on page 25.

Ejecting discs

1 Press the [DISC EJECT▲] button to eject the disc.

The disc is ejected from the disc insertion slot.

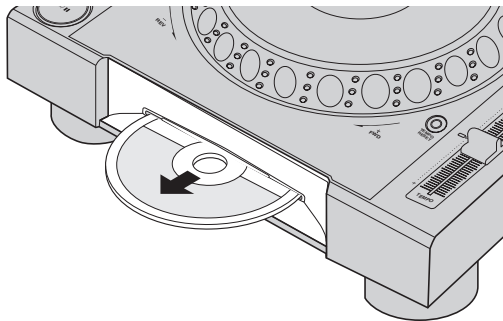

2 Pull the disc out, being careful not scratch its signal surface.

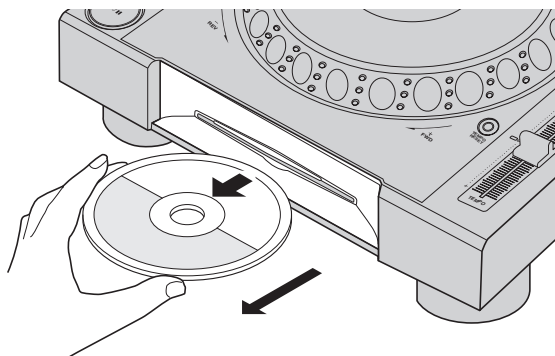

- If the [DISC EJECT▲] button is pressed accidentally, press the [▶/II] button immediately. Disc ejection is canceled and the unit is reset to as it was directly before the [DISC EJECT▲] button was pressed. (No sound is output during the resetting process.)
- When [EJECT/LOAD LOCK] on the [UTILITY] menu is set to [LOCK], discs cannot be ejected during playback. Either set [EJECT/LOAD LOCK] to [UNLOCK] or press the [▶/II] button to pause playback, then press the [DISC EJECT▲] button.

❖ About the resume function

If a disc is ejected during playback, when that same disc is reloaded, playback resumes from the point playing when the disc was ejected. If a disc is ejected while pausing, when that disc is reloaded, it pauses at the same point as when it was ejected. These points are stored in the memory until this unit's power is turned off or a different disc is loaded.

- This function does not work with storage devices (SD, USB).

Inserting and ejecting SD memory cards

- Do not insert any objects other than SD memory cards into the SD memory card insertion slot. Inserting coins or other metal objects could damage the internal circuitry, resulting in malfunction.
- Do not forcibly insert or remove SD memory cards. Doing so could damage the SD memory card or this unit.

Inserting SD memory cards

- 1 Press the [⏻] switch to turn this unit's power on.
- 2 Open the SD memory card door.
- 3 Insert the SD memory card.

Insert the SD memory card vertically, with the back side facing forward and the notch facing down. Push the card in slowly until it stops.

- 4 Close the SD memory card door.
-

Ejecting SD memory cards

- 1 Open the SD memory card door.

The SD memory card indicator flashes for several seconds.

- Do not pull out the SD memory card or turn off this unit's power while the SD memory card indicator is flashing. Doing so could delete this unit's management data and damage the SD memory card, making it impossible to read.

- 2 Press the SD memory card in. When it pops back up, pull it out vertically.
 - 3 Close the SD memory card door.
-

Connecting and disconnecting USB devices

Connecting USB devices

- 1 Press the [⏻] switch to turn this unit's power on.
 - 2 Open the cover of the USB device insertion slot and connect the USB device.
-

Disconnecting USB devices

- 1 Press the [USB STOP] button until the USB indicator stops flashing.
Do not remove the USB device or turn Off the power of the unit while the USB indicator is flashing. The management data in the unit may get deleted. Also, the USB device may become unreadable.
 - 2 Disconnect the USB device.
 - 3 Close the cover of the USB device insertion slot.
-

Playback

This section describes basic track selection operations and how to switch the screen.

- *Playing storage devices (SD, USB) of other players and mobile devices on which rekordbox is installed (p.20)*
 - *Playing the rekordbox library on a computer or mobile device (p.21)*
-

Playing media connected to or inserted in this unit

- 1 Load the medium in this unit.
 - *Inserting discs (p.19)*
 - *Inserting SD memory cards (p.20)*
 - *Connecting USB devices (p.20)*
-

- 2 Press the corresponding medium button ([DISC], [SD] or [USB]).

The tracks or folders are displayed on a list.

The medium whose contents are displayed on the main unit display can be switched.

[DISC] button: Displays the contents on the inserted disc.

[SD] button: Displays the contents on the inserted SD memory card.

[USB] button: Displays music files in the connected USB device or mobile device on which rekordbox is installed.

- For details on the [LINK] button, see *Playing storage devices (SD, USB) of other players and mobile devices on which rekordbox is installed* on page 20.
- For details on the [rekordbox] button, see *Playing the rekordbox library on a computer or mobile device* on page 21.

- 3 Turn the rotary selector.

Move the cursor and select the item.



- Press the rotary selector to move to a lower level in the folder. Press the [BACK] button to return to the level above.
- When the [BACK] button is pressed for over 1 second or the medium button for the medium being browsed is pressed, the display moves to the topmost level.
- Tracks in the currently playing track's category/folder of can also be selected using the [TRACK SEARCH I◀◀, ▶▶] buttons.

- 4 Select the track and press the rotary selector.

When the track is loaded, the screen switches to the normal playback screen.

The track is loaded, playback starts, and the corresponding medium button flashes.

- For details on the normal playback screen, see *Main unit display* on page 17.
 - When [EJECT/LOAD LOCK] on the [UTILITY] menu is set to [LOCK], it is not possible to load other tracks during playback. Either set [EJECT/LOAD LOCK] to [UNLOCK] or press the [PLAY/PAUSE▶/II] button to pause, then load the track.
 - When a track has been loaded while pausing, press the [PLAY/PAUSE▶/II] button to start playback.
 - When auto cue is turned on, the disc pauses at the audio start position. In this case, press the [PLAY/PAUSE▶/II] to start playback.
 - For details on auto cue, see *Setting auto cue* on page 23.
-

Playing storage devices (SD, USB) of other players and mobile devices on which rekordbox is installed

Display the contents of the storage device (SD, USB) or of the mobile device on which rekordbox is installed that is connected to the other player connected to this unit by PRO DJ LINK on this unit's screen.

- The information of discs inserted on other players cannot be browsed.

- 1 Connect the storage device (SD, USB) or mobile device on which rekordbox is installed to the other player connected to this unit by PRO DJ LINK.

- 2 Press the [LINK] button.

The tracks and/or folders on the storage device (SD, USB) or mobile device on which rekordbox is installed that is connected to the other player are displayed.

- When multiple media are connected, a screen for selecting the medium appears.

3 Turn the rotary selector.

Move the cursor and select the item.



4 Select the track and press the rotary selector.

When the track is loaded, the screen switches to the normal playback screen.

The track is loaded, playback starts, and the corresponding medium button flashes.

- ➔ For details on the normal playback screen, see *Main unit display* on page 17.

❖ If the medium contains the rekordbox library

If the SD memory card or USB device inserted into/connected to this unit or another player connected by PRO DJ LINK contains rekordbox library information, the rekordbox library is displayed.

- Music files are displayed in the categories (album, artist, etc.) set with rekordbox.
- The types of items on the category menu can be changed in rekordbox's preferences.

Playing the rekordbox library on a computer or mobile device

Music files are displayed in the categories (album, artist, etc.) set with rekordbox.

1 Press the [rekordbox] button.

The rekordbox library is displayed on this unit's main unit display.

- With wireless LAN (Wi-Fi) connections, if **[Please push the rotary selector to permit mobile connection.]** appears on this unit's main unit display when connecting, connection is possible by pressing the rotary selector.
- To select a mobile device connected by USB, press the [USB] button. Also, to select a mobile device connected to another player that is connected by PRO DJ LINK, press the [LINK] button.

2 Turn the rotary selector.

Move the cursor and select the item.

3 Select the track and press the rotary selector.

When the track is loaded, the screen switches to the normal playback screen.

The track is loaded, playback starts, and the corresponding medium button flashes.

- ➔ For details on the normal playback screen, see *Main unit display* on page 17.

Load previous tracks

The names of the last eight tracks that were played can be displayed and these tracks can be selected.

1 Display the normal playback screen.

2 Press the [MENU/UTILITY] button.

3 Turn the rotary selector to select the track, then press the rotary selector to set playback.

- The display of the track names is canceled by pressing the [MENU/UTILITY] or [BACK] button.

Pausing

During playback, press the [PLAY/PAUSE ►/II] button.

The [PLAY/PAUSE ►/II] and [CUE] buttons flash. When the [PLAY/PAUSE ►/II] button is pressed again, playback resumes.

- When tracks have been loaded from a disc, the disc automatically stops spinning if no operation is performed for 100 minutes while in the pause mode.

Forward and reverse scanning

Press one of the [SEARCH ◀◀, ▶▶] buttons.

The track is scanned in the forward or reverse direction while one of the [SEARCH ◀◀, ▶▶] buttons is pressed.

- It is not possible to move to a different category or folder during forward or reverse scanning.

Finding the beginnings of tracks (Track Search)

Press one of the [TRACK SEARCH ◀◀, ▶▶] buttons.

Press the [▶▶] to move to the beginning of the next track.

When [◀◀] is pressed, playback returns to the beginning of the currently playing track. When pressed twice in a row, playback returns to the beginning of the previous track.

- It is not possible to move to a different category or folder with the track search function.

Adjusting the playing speed (Tempo control)

Press the [TEMPO ±6/±10/±16/WIDE] button.

The [TEMPO] slider's adjustment range switches each time the button is pressed. The adjustment range setting is indicated on the main unit display.

Setting value	Units of adjustment
±6	0.02 %
±10	0.05 %
±16	0.05 %
WIDE	0.5 %

The [WIDE] adjustment range is ±100%. When set to -100%, playback stops.

- The adjustment range is set to ±10% when the power is turned on.

Move the [TEMPO] slider forward or backward.

The tempo increases when moved to the [+] side (down), decreases when moved to the [-] side (up). The rate at which the playing speed is changed is indicated on the playing speed display.

Adjusting the playing speed without changing the pitch (Master Tempo)

Press the [MASTER TEMPO] button.

The [MASTER TEMPO] button and [MT] indicator on the main unit display light.

Move the [TEMPO] slider forward or backward.

The pitch does not change even when the playing speed is changed with the [TEMPO] slider.

- The sound is digitally processed, so the sound quality decreases.
- The master tempo setting remains in the memory, even when the power is turned off.

Playing in reverse

- When the quantize function is on, there may be a slight delay in operation of this function in order to synchronize the beat.

Tilt the [DIRECTION FWD/REV/SLIP REV] lever to the [REV] side.

The [REV] indicator lights and the track is played in the reverse direction.

- When the music files are recorded in a folder structure, only tracks within the same category/folder can be played in reverse. Also note that reverse playback may not start immediately.
- The direction in which the playing speed is increased or decreased according to the direction in which the jog dial is turned is reversed.
- When such operations as track searching and loop playback are performed during reverse playback, the audio memory status display on the jog dial display section flashes and scratch play may not be possible.

Operating the jog dial

- The top of the jog dial has an embedded switch. Do not place objects on the jog dial or subject it to strong forces.
- Water or other liquids getting into the set will lead to malfunction.

Switching the jog dial mode

Press the [JOG MODE] button.

The mode switches between VINYL and CDJ each time the button is pressed.

- VINYL mode: When the top of the jog dial is pressed during playback, playback stops, and when the jog dial is spun at this time sound is produced according to the direction in which the jog dial is spun.
- CDJ mode: Playback does not stop even when the top of the jog dial is pressed. Such operations as scratching cannot be performed.

Pitch bend

During playback, spin the outer section of the jog dial without touching the top.

The playing speed increases when spun clockwise, decreases when spun counterclockwise. When spinning is stopped, playback returns to the normal speed.

- When the jog mode is set to the CDJ mode, the same operation can be performed by spinning the top of the jog dial.

Adjusting the load when the jog dial is spun

Turn the [JOG ADJUST] control.

The load gets heavier when turned clockwise, lighter when turned counterclockwise.

Scratch

When the jog mode is set to the VINYL mode, tracks can be played according to the direction and speed at which the jog dial is spun by spinning the top of the jog dial while pressing it.

1 Press the [JOG MODE] button.

Set the jog mode to VINYL.

2 During playback, press the top of the jog dial.

Playback slows then stops.

3 Spin the jog dial in the desired direction and at the desired speed.

The sound is played according to the direction and speed at which the jog dial is spun by spinning the top of the jog dial while pressing it.

4 Release your hand from the top of the jog dial.

Normal playback resumes.

Frame search

In the pause mode, spin the jog dial.

The position at which the track is pausing can be moved in units of 0.5 frames.

- The approximate time for 0.5 frame is 6.7 msec.
- The position is moved in the direction of the playback when the jog dial is spun clockwise, in the reverse direction when it is spun counterclockwise. The position moves 1.8 seconds for one revolution of the jog dial.

Super fast search

Turn the jog dial while pressing one of the [SEARCH ◀◀, ▶▶] buttons.

The track is fast-forwarded/fast-reversed in the direction in which the jog dial is spun.

- When the [SEARCH ◀◀, ▶▶] button is released, this function is canceled.
- When you stop the jog dial from spinning, normal playback resumes.
- The fast-forward/fast-reverse speed can be adjusted according to the speed at which the jog dial is spun.

Super fast track search

Turn the jog dial while pressing one of the [TRACK SEARCH I◀◀, ▶▶I] buttons.

The track is advanced at high speed in the direction in which the jog dial was turned.

Adjusting the playback and stopping speeds

This function is only valid when the jog mode is set to the VINYL mode.

Adjusting the speed at which playback stops

The speed at which playback stops when the top of the jog dial is pressed or when playback is stopped by pressing the [PLAY/PAUSE▶/II] button can be changed.

Turn the [VINYL SPEED ADJUST TOUCH/BRAKE] control.

The speed increases when turned clockwise, decreases when turned counterclockwise.

Adjusting the speed at which the normal playing speed is reached

The speed at which the normal playing speed is reached when the top of the jog dial is released or when the [PLAY/PAUSE▶/II] button is pressed while pausing can be changed.

- If the slip scratch play is canceled and playback in the background resumes, this function is disabled.

Turn the [VINYL SPEED ADJUST RELEASE/START] control.

The speed increases when turned clockwise, decreases when turned counterclockwise.

Advanced Operation

Setting Cue

1 During playback, press the [PLAY/PAUSE ►/II] button.
Playback is paused.

2 Press the [CUE] button.

The point at which the track is paused is set as the cue point. The [PLAY/PAUSE ►/II] indicator flashes and the [CUE] indicator lights. No sound is output at this time.

- When a new cue point is set, the previously set cue point is canceled.

Adjusting the cue point position

1 Press the [SEARCH ◀◀, ▶▶] buttons while pausing at the cue point.

The [PLAY/PAUSE ►/II] and [CUE] indicators flash.

2 Press one of the [SEARCH ◀◀, ▶▶] buttons.

The cue point can be fine-adjusted in steps of 0.5 frames.

- The same operation is possible using the jog dial.

3 Press the [CUE] button.

The position at which the button was pressed is set as the new cue point.

- When a new cue point is set, the previously set cue point is canceled.

Returning to Cue Point (Back Cue)

During playback, press the [CUE] button.

The set immediately returns to the currently set cue point and pauses.

- When the [PLAY/PAUSE ►/II] button is pressed, playback starts from the cue point.

Checking Cue Point (Cue Point Sampler)

Keep pressing the [CUE] button after returning to the cue point.

Playback starts from the set cue point. Playback continues while the [CUE] button is pressed.

- If the [PLAY/PAUSE ►/II] button is pressed while sampling the cue, playback continues even if the [CUE] button is released.

Setting Cue Point during playback (Real Time Cue)

During playback, press the [IN/CUE (IN ADJUST)] button at the point at which you want to set a cue point.

The point at which the button was pressed is set as the cue point.

Setting auto cue

When a track is loaded or the track search operation is performed, the silent section at the beginning of the track is skipped and the cue point is automatically set at the point immediately before the sound starts.

Press the [TIME MODE/AUTO CUE] button for over 1 second.

[A. CUE] lights.

- When [TIME MODE (AUTO CUE)] is pressed again for at least 1 second, auto cue is set to off.
- The auto cue level setting remains in the memory, even when the power is turned off.

Setting loops

This function can be used to play specific sections repeatedly.

- Loops that include sections in different tracks can only be set for tracks recorded on music CDs (CD-DA).
- When the quantize function is on, there may be a slight delay in operation of this function in order to synchronize the beat.

1 During playback, press the [IN/CUE (IN ADJUST)] button at the point at which you want to start loop playback (the loop in point).

Loop In Point is set.

- This operation is not necessary if you want to set the currently set cue point as the loop in point.

2 Press the [LOOP OUT (OUT ADJUST)] button at the point at which you want to end loop playback (the loop out point).

The loop out point is set, and loop playback begins.

Fine-adjusting the loop in point (loop in adjust)

1 During loop playback, press the [IN/CUE (IN ADJUST)] button.

The [IN/CUE (IN ADJUST)] button flashes fast and the light of the [LOOP OUT (OUT ADJUST)] button turns off.

The loop in point's time is displayed on the main unit display.

2 Press one of the [SEARCH ◀◀, ▶▶] buttons.

The loop in point can be adjusted in units of 0.5 frames.

- The same operation is possible using the jog dial.
- The loop in point's range of adjustment is ± 30 frames.
- The loop in point cannot be set at a point beyond the loop out point.

3 Press the [IN/CUE (IN ADJUST)] button.

Loop playback resumes.

- Normal loop playback also resumes if no operation is performed for over 10 seconds.

Fine-adjusting the loop out point (loop out adjust)

1 During loop playback, press the [LOOP OUT (OUT ADJUST)] button.

The [LOOP OUT (OUT ADJUST)] button flashes fast and the light of the [IN/CUE (IN ADJUST)] button turns off.

The loop out point's time is displayed on the main unit display.

2 Press one of the [SEARCH ◀◀, ▶▶] buttons.

The loop out point can be adjusted in units of 0.5 frames.

- The same operation is possible using the jog dial.
- The loop out point cannot be set at a point before the loop in point.

3 Press the [LOOP OUT (OUT ADJUST)] button.

Loop playback resumes.

- Normal loop playback also resumes if no operation is performed for over 10 seconds.

Canceling Loop playback (Loop Exit)

During loop playback, press the [RELOOP/EXIT] button.

Playback continues beyond the Loop Out Point without returning to the Loop In Point.

Returning to Loop playback (Re-loop)

After canceling loop playback, press the [RELOOP/EXIT] button during playback.

Playback returns to the previously set Loop In Point, and Loop playback resumes.

Setting loops automatically (4-beat Loop)

Press the [4/8BEAT (LOOP CUTTER)] button during playback.

A loop extending 4 beats from the point at which the button was pressed is set automatically according to the BPM of the track currently being played and loop playback starts.

- If the track's BPM cannot be detected, the BPM is set to 130.
- 4-beat loop can also be set by pressing the [IN/CUE (IN ADJUST)] button for over 1 second.

❖ 8-beat loop

Press the [4/8BEAT (LOOP CUTTER)] button for over 1 second during playback.

A loop extending 8 beats from the point at which the button was pressed is set automatically and loop playback begins.

Cutting loops (Loop Cut)

During loop playback, press the [CUE/LOOP CALL◀ (LOOP 1/2X)] button.

The loop playing time is cut in half each time the button is pressed.

- A loop can be divided by pressing the [4/8BEAT (LOOP CUTTER)] button during loop playback.

Extending loops (loop doubling)

During loop playback, press the [CUE/LOOP CALL▶ (LOOP 2X)] button.

The loop's length is doubled each time the button is pressed.

Setting the loop automatically based on the track's tempo (Auto Beat Loop)

A loop with the specified number of beats is set and loop playback starts.

1 Touch [LOOP MODE] during playback.

The beat number selection screen appears on the main unit display.

- The beat select screen is also displayed when loops are set and when the slip function is turned on.



2 Touch the beat you want to set.

The touched number of beats lights and loop playback starts with the selected number of beats.

3 Touch [LOOP MODE].

The beat number selection screen turns off.

- The beat select screen also turns off when a track is loaded.
- When a track that has not been analyzed is playing, the loop is set according to the track's BPM.
- If the track's BPM cannot be detected, the BPM is set to 130.

Using active loops

1 Connect a storage device (SD, USB) to this unit.

2 Load a track for which an active loop has been set with rekordbox.

One loop stored in rekordbox can be set as the active loop.

The set active loop points are indicated on the waveform display as shown below.

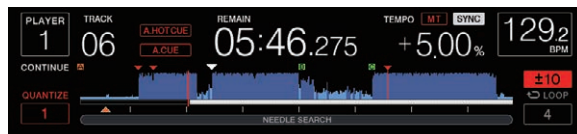

When the set point is reached, the loop is set automatically and loop playback begins.

Emergency loops

With this unit, a 4-beat loop is set automatically to prevent the sound from being interrupted if a track can no longer continue to play.

- DJ playback is restricted during emergency looping. To cancel emergency looping, load the next track.

Setting Hot Cue

When a hot cue is set, that point can be called out and played instantaneously. Up to 8 hot cues can be set per music track.

- Press [BANK] button to switch between [HOT CUE] (A, B, C, D) and [HOT CUE] (E, F, G, H).
- Up to four hot cues can be set per disc. [HOT CUE] (E, F, G, H) cannot be used.
- When the quantize function is on, there may be a slight delay in operation of this function in order to synchronize the beat.

1 Connect a storage device (SD, USB) to this unit.

2 During playback or pause, press one of the [HOT CUE] (A to H) buttons at the point at which you want to set a hot cue.

The point at which the button was pressed is set as a hot cue, and the corresponding [HOT CUE] button lights.

- During loop playback, the loop is registered as a hot cue. The direction of playback is not recorded for hot cues. While the hot cue is being recorded, it is not possible to record other hot cues, to set cue points, to scan in the forward or reverse direction or to scratch.
- When a storage device (SD, USB) is connected to this unit, the point information is automatically stored on it.
- When a hot cue is set during scratch play, playback may stop temporarily.
- Hot cues cannot be set to the [HOT CUE] (A to H) buttons that a hot cue is already set to. To set a new hot cue, first delete the hot cue stored on the button.
- For the hot cues on discs, the point information for the hot cues set to [HOT CUE] (A, B, C) can only be stored on a storage device (SD, USB).

Playing hot cues

During playback or pause, press one of the [HOT CUE] (A to H) buttons.

The hot cue recorded at that button is called out and playback begins.

- The information of the loop play stored on the [HOT CUE] button is different from the loop play set by the [IN/CUE (IN ADJUST)] and [LOOP OUT (OUT ADJUST)] buttons.
- After the loop stored on the [HOT CUE] button is called out, you can cancel the loop playback with the [RELOOP/EXIT] button. You can also fine-tune the loop in point with the [LOOP IN (IN ADJUST)] button or the loop out point with the [LOOP OUT (OUT ADJUST)] button. The adjustment directly changes the information stored on the [HOT CUE] (A to H) buttons.

❖ Lighting color of the [HOT CUE] (A to H) buttons

When [HOT CUE COLOR] of the [UTILITY] menu is set to [OFF]

Contents recorded as hot cue	Button color when lit
Cue Point	Green
Loop	Orange
Nothing is recorded.	Not lit

When [HOT CUE COLOR] of the [UTILITY] menu is set to [ON]

Contents recorded as hot cue	Button color when lit
Cue Point	Fixed color of each button
Loop	Orange
Nothing is recorded.	Not lit

- When playing tracks on discs, the [OFF] settings are applied for the hot cues registered in hot cue banks, regardless of the setting.
- The hot cue colors can be set with rekordbox.

Calling out hot cues

❖ Procedure for calling out hot cues (for discs)

To call out hot cues using storage devices (SD, USB), the disc's hot cues must first be stored using the storage device (SD, USB).

1 Connect the storage device (SD, USB) on which the disc's hot cues are stored.

2 Load a disc in this unit.

The unit switches to the hot cue call-out mode and the [HOT CUE] ((A, B, C)) buttons on which a hot cue is stored flash.

3 Press the [HOT CUE] ((A, B, C)) button whose hot cue you want to call out.

The hot cue is called out, and the [HOT CUE] ((A, B, C)) button lights in green or orange.

- If you do not want to call out the hot cue, press the [HOT CUE] (CALL/DELETE) button without pressing the [HOT CUE] ((A, B, C)) button. The light of the buttons whose hot cue is not called out turns off.
- When playing tracks recorded on media other than discs, hot cues cannot be called out even when a disc for which hot cues are recorded is loaded in the this unit.
- If the hot cue call-out mode is cancelled accidentally, disconnect the storage device (SD, USB), then reconnect it.

❖ Call-out procedure (storage device (SD, USB))

1 Connect a storage device (SD, USB) to this unit.

2 Load the track whose hot cue you want to call out.

3 Press the [HOT CUE] (CALL/DELETE) button.

The unit switches to the hot cue call-out mode and the [HOT CUE] (A to H) buttons on which a hot cue is stored flash.

4 Press the [HOT CUE] (A to H) button whose hot cue you want to call out.

The hot cue is called out, and the [HOT CUE] (A to H) button lights in green or orange. If the hot cue color has been set using rekordbox or the unit, the button lights in the set color.

- If you do not want to call out the hot cue, press the [HOT CUE] (CALL/DELETE) button without pressing the [HOT CUE] (A to H) button. The light of the buttons whose hot cue is not called out turns off.
- If you accidentally cancel the hot cue call-out mode, press the [HOT CUE] (CALL/DELETE) button again.





❖ Calling out hot cues automatically when tracks are loaded (storage device (SD, USB))

The player settings can be changed to automatically call out hot cues when tracks are loaded.

1 Press the [SHORTCUT] button.

2 Select ON, rekordbox SETTING or OFF of HOT CUE AUTO LOAD on the [SHORTCUT] screen.

The setting can also be changed in [UTILITY].

- **ON:**
 is displayed for all tracks and hot cues are automatically called out when the tracks are loaded. Hot cues are also automatically called out when the track search is performed.
 [A. HOT CUE] on the main unit display lights in red.
- **rekordbox SETTING:**
 is displayed only for the tracks set with rekordbox, and hot cues are automatically called out when the tracks displayed with  are loaded. Hot cues are not called out when the track search is performed.
 [A. HOT CUE] on the main unit display lights in white.
- **OFF:**
 is not displayed. Hot cues are not called out when tracks are loaded.

❖ Canceling the hot cue call out mode

Perform one of the operations below to cancel the hot cue call out mode. When tracks have been loaded from a disc, the hot cue call-out mode is not canceled even if the track being played is changed.

1 Calling out all hot cues

2 Press the [HOT CUE] (CALL/DELETE) button.

3 Change the track to be played on the storage device (SD, USB).

❖ Deleting hot cues

Press one of the [HOT CUE] (A to H) buttons while pressing the [CALL/DELETE] button.

The hot cue stored on the corresponding button is deleted, and a new hot cue can be stored on the button.

Storing cue or loop points

1 Connect a storage device (SD, USB) to this unit.

2 Set Cue Point or Loop Point.

3 Press the [MEMORY] button.

[MEMORY] or [MEMORY] is displayed for several seconds on the main unit display, and the point information is stored on the storage device (SD, USB).

Stored cue and loop points are indicated [] at the top of the waveform display.

- When a track recorded on a disc is playing, if both an SD memory card and a USB device are connected, the point information is stored with priority on the SD memory card. The storage device to store the information to can be selected in [MENU]. It is also possible to select a storage device connected to other DJ players by PRO DJ LINK.
- To store loop points, press the [MEMORY] button during loop playback.

Calling out stored cue or loop points

1 Connect a storage device (SD, USB) to this unit.

2 Load the track whose cue or loop points you want to call out.

Stored cue and loop points are indicated [] at the top of the waveform display.

3 Press the [CUE/LOOP CALL ◀(LOOP 1/2X)] or [CUE/LOOP CALL ▶(LOOP 2X)] button.

Press [CUE/LOOP CALL ◀(LOOP 1/2X)] to call out a point before the currently playing position, [CUE/LOOP CALL ▶(LOOP 2X)] to call out a point after the currently playing position.

The track cues to the called out point and pauses.

- When multiple points are stored, a different point is called out each time the button is pressed.
- Loops set as active loops can also be called out as stored loops.
- If a comment is set to the called out point by rekordbox, the comment is displayed in the area where the track name is displayed.

4 Press the [PLAY/PAUSE ▶/II] button.

Normal or loop playback starts from the point that was called out.

Deleting stored cue or loop points

Deleting points individually

1 Connect a storage device (SD, USB) to this unit.

2 Load the track containing the cue point or loop points you want to delete.

Stored cue and loop points are indicated [] at the top of the waveform display.

3 Press the [CUE/LOOP CALL ◀(LOOP 1/2X)] or [CUE/LOOP CALL ▶(LOOP 2X)] button to call out the point to be deleted.

The track cues to the called out point and pauses.

- When multiple points are stored, a different point is called out each time the button is pressed.

4 Press the [DELETE] button.

[DELETE] or [DELETE] is displayed on the main unit display, and the selected point information is deleted.

- When a stored loop set as an active loop is deleted, the active loop is also deleted.

Deleting points in units of discs

1 Load a disc in this unit.

When tracks from a medium other than a disc are loaded, load any track from the disc.

2 Connect a storage device (SD, USB) to this unit.

3 Press the [DELETE] button for over 5 second.

[DISC CUE/LOOP DATA-DELETE? PUSH MEMORY] appears on the main unit display.

4 Press the [MEMORY] button.

All cue and loop points for the disc currently loaded in this unit are deleted.

- The delete mode is canceled if any button other than [MEMORY] is pressed.

Deleting all the disc information stored on a storage device (SD, USB)

Connect the storage device (SD, USB) on which the disc information is stored to this unit.

1 Connect a storage device (SD, USB) to this unit.

2 With no disc loaded on this unit, press the [DELETE] button for over 5 seconds.

[DISC CUE/LOOP DATA-DELETE ALL? PUSH MEMORY] appears on the main unit display.

3 Press the [MEMORY] button.

All the disc information stored on the storage device (SD, USB) is deleted.

- The delete mode is canceled if any button other than [MEMORY] is pressed.

Setting the cue point for auto cueing

The cue point to be set as the auto cue can be selected using one of the methods below.

Setting the cue point by the acoustic pressure level identified as a silent section (8 levels)

–36 dB, –42 dB, –48 dB, –54 dB, –60 dB, –66 dB, –72 dB and –78 dB

Automatically setting stored cues as cue points

MEMORY: The stored cue point nearest the beginning of the track is set as the cue point for auto cueing.

- When [MEMORY] is set, [A. CUE] lights in white on the main unit display.

The setting of the cue point for auto cueing can be changed using one of the methods below.

1 Press the [MENU/UTILITY] button for over 1 second.

The [UTILITY] screen is displayed.

2 Turn the rotary selector then press it.

Select [AUTO CUE LEVEL].

3 Turn the rotary selector then press it.

Select the acoustic pressure level or [MEMORY].

Using beat jump/loop move

The playback position can be moved one beat forward or backward.

Touch [1BEAT].

- If it is touched during loop playback, the loop playback position moves.
- If the track's BPM cannot be detected, the BPM is set to 130.
- When the quantize function is on, the sound is matched to the beat, so there may be a slight delay in the function's operation.

Using the slip mode

When the slip mode is turned on, normal playback with the original rhythm continues in the background while in the pause (vinyl mode), scratch play, loop play, hot cue play and reverse play modes. When the slip mode is canceled, normal playback resumes from the point reached while the slip mode was turned on.

- When the quantize function is on, there may be a slight delay in operation of this function in order to synchronize the beat. (Slip beat loop, slip reverse and slip hot cue only)

Display of the position playing in the background



- When in the slip mode, the currently playing position is indicated by a yellow line on the main unit display's waveform display (overall waveform or enlarged waveform). The position playing in the background is indicated by a white line on the main unit display's waveform display (overall waveform).
- It is also displayed on the jog dial's slip play display.

Slip pausing

1 Press the [JOG MODE] button.

Set the jog mode to VINYL.

2 Press the [SLIP] button.

The mode switches to the slip mode.

3 During playback, press the [PLAY/PAUSE ►/II] button.

Normal playback continues in the background even while in the pause mode.

The [SLIP] button flashes in beat with the sound playing in the background.

4 Press the [PLAY/PAUSE ►/II] button to cancel the pause mode.

Normal playback of the sound that was playing in the background resumes.

Slip scratching

1 Press the [JOG MODE] button.

Set the jog mode to VINYL.

2 Press the [SLIP] button.

The mode switches to the slip mode.

3 During playback, press the top of the jog dial.

The scratch play mode is set.

Normal playback continues in the background even while scratching.

The [SLIP] button flashes in beat with the sound playing in the background.

4 Release your hand from the top of the jog dial.

Normal playback of the sound that was playing in the background resumes.

Slip looping

1 Press the [SLIP] button.

The mode switches to the slip mode.

2 Press the [IN/CUE (IN ADJUST)] button, and then press the [LOOP OUT (OUT ADJUST)] button.

Loop playback starts.

Normal playback continues in the background even during loop playback.

The [SLIP] button flashes in beat with the sound playing in the background.

- Loops of over 8 seconds cannot be set.

The operations are the same as when a loop is set by the following methods.

- Press the [4/8BEAT (LOOP CUTTER)] button.
- Press the [IN/CUE (IN ADJUST)] button for over 1 second.

3 Press the [RELOOP/EXIT] button.

Looping is canceled, and normal playback of the sound that was playing in the background resumes.

Slip beat looping

1 Press the [SLIP] button.

The mode switches to the slip mode.

2 Touch and hold the beat you want to set.

The loop is set automatically and loop playback begins.

Normal playback continues in the background even during loop playback.

The [SLIP] button flashes in beat with the sound playing in the background.

- The beat select screen is displayed when the slip mode is turned on.
- A different beat can also be selected by sliding your finger.

3 Release your finger from the selected beat.

Normal playback of the sound that was playing in the background resumes.

4 Press the [RELOOP/EXIT] button.

The last loop that was set is played and the slip loop mode is set.

- When slip beat looping is canceled after selecting a different beat by sliding your finger, the loop set first (during playback) is called out with the [RELOOP/EXIT] button.

Slip reverse

1 Press the [SLIP] button.

The mode switches to the slip mode.

2 Tilt the [DIRECTION FWD/REV/SLIP REV] lever to the [REV] side during playback.

The [REV] indicator lights and the track is played in the reverse direction. Normal playback continues in the background even during reverse playback.

The [SLIP] button flashes in beat with the sound playing in the background.

- The slip reverse mode is automatically canceled at the position 8 beats past the position at which the [DIRECTION FWD/REV/SLIP REV] lever is tilted to the [REV] side, normal playback of the sound playing in the background resumes and the [REV] indicator flashes.
- If the [DIRECTION FWD/ REV/SLIP REV] lever is tilted to the [FWD] side before 8 beats elapse, the slip reverse mode is canceled and normal playback of the sound playing in the background resumes.
- If the [DIRECTION FWD/REV/SLIP REV] lever is tilted to the SLIP REV side, the slip reverse is performed while the lever is tilted regardless of whether SLIP is turned on or off.

Slip hot cue

1 Press the [SLIP] button.

The mode switches to the slip mode.

2 Press and hold the [HOT CUE] (A to H) button.

Hot cueing begins.

Normal playback of the sound playing in the background continues even while the [HOT CUE] (A to H) button is pressed.

The [SLIP] button flashes in beat with the sound playing in the background.

- At the point 4 beats after hot cueing began, the slip hot cue mode is automatically canceled and normal playback of the sound that was playing in the background resumes.

3 Release your finger from the [HOT CUE] (A to H) button.

If the [HOT CUE] (A to H) button is released before 4 beats elapse from the starting position of the hot cue, normal playback of the sound playing in the background resumes.

Canceling the slip mode

Press the [SLIP] button.

The slip mode is canceled.

- The slip mode is also canceled when a track is loaded.

Playing from the touched position on the waveform display

Touch the waveform display with your finger to easily play the audio starting from the touched position. Move your finger while touching the waveform display to quickly move to the desired position.

You can perform track search by touching the waveform display only in the following conditions.

- In the pause mode
- While the jog dial is being pressed with the jog mode set to VINYL

Touch the waveform display during pause.

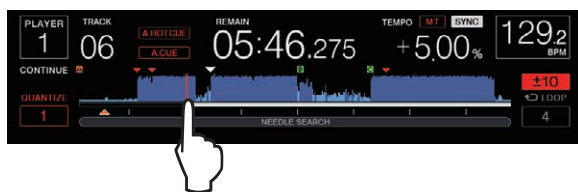

The current playing position on the playing address display moves to the touched point.

- If you move your finger quickly, the playing address display may not be shown properly.

Using the beat sync function

When beat sync is turned on, the BPM and beat position of tracks played on this unit can automatically be synchronized with the DJ player connected by PRO DJ LINK that is set as the sync master.

- The beat sync function does not operate for tracks that have not been analyzed with rekordbox.

1 Press the [BEAT SYNC MASTER] button on the DJ player you want to set as the sync master.

Set the DJ player you want to be the sync master.

When the beat sync function is on, the BPM display on the DJ player set as the sync master changes to orange.

- rekordbox (Mac/Windows) can also be set as the sync master.
 - ➔ For the procedure to set rekordbox (Mac/Windows) as a sync master, see the rekordbox (Mac/Windows) user's manual.

2 Press the [BEAT SYNC] button.

The BPM and beat position of the currently playing track are synchronized to the sync master.

- During synchronization, tempo control with the tempo slider is disabled and the playing speed display switches to the tempo slider position's BPM display, displayed in gray.

Changing the DJ player set as the sync master

The sync master can be changed to another DJ player connected by PRO DJ LINK as described below.

- Change or pause the track on the DJ player set as the sync master.
- Press the [BEAT SYNC MASTER] button on the DJ player set as the sync master.
- Press the [BEAT SYNC MASTER] button on a DJ player other than the one set as the sync master.

Starting playback from the same playback position as the track loaded in the DJ player set as the sync master

You can start playback from the same playback point as the track loaded in the DJ player set as the sync master using the DJ player not set as the sync master by the following methods.

- Load the track loaded in the DJ player set as the sync master to the DJ player not set as the sync master.
- Press the [BEAT SYNC/INST.DOUBLE] button of the DJ player not set as the sync master for over 1 second.

Canceling synchronization

Press the [BEAT SYNC/INST.DOUBLE] button.

- If the synchronized playing tempo (BPM) and the slider position's tempo (BPM) do not match, the synchronized playing tempo is maintained and tempo control with the tempo slider remains disabled. Normal operation is restored when the position of the tempo slider is moved to the synchronized playing tempo position.
- If the pitch is bent using the DJ player not set as the sync master, the synchronization is canceled and the [BEAT SYNC/INST.DOUBLE] button flashes.

Adjusting the beat grid

The enlarged waveform displays the beat grid with red lines. The beat grid can be adjusted by the following procedure.

1 Press the rotary selector for at least 1 second.

The mode switches to the [GRID ADJUST] mode.

2 When the rotary selector is turned, the beat grid is adjusted.

You can adjust from the menu screen by touching the [MENU/UTILITY] button.

- [RESET]: Resets the adjusted beat grid.
- [SNAP GRID(CUE)]: Moves the first beat to the position of the currently set cue.
- [SHIFT GRID]: Reflects the results adjusted during synchronization (pitch bend, etc.) on the beat grid.

3 Press the rotary selector for at least 1 second.

Return to [ZOOM] mode.

Operating the CDJ-2000NXS2 in combination with other devices

When connected by a LAN cable to a Pioneer DJ's DJ mixer, operations such as starting playback on this unit can be controlled with the DJ mixer's fader.

- Connect this unit to a Pioneer DJ's DJ mixer beforehand. For instructions on connecting, see *Connections* on page 9.
- For instructions on setting the player number, see *Connecting to a mixer with only one LAN port* on page 9.
- Also refer to the description of the fader start function included in the operating instructions of Pioneer DJ's DJ mixer.

Starting playback using a DJ mixer's fader (Fader Start)

1 Connect this unit to a Pioneer DJ's DJ mixer using a LAN cable.

For instructions on connecting, see *Basic style* on page 9.

2 Turn on the DJ mixer's fader start function.

3 Set cues on this unit.

4 Move the DJ mixer's channel fader or cross fader.

This unit's pause mode is canceled and the track is played instantaneously.

- When the channel fader or cross fader is set back to its original position, playback cues back to the set cue point and the pause mode is set (Back Cue).

Browsing tracks

The various devices and the rekordbox library on the connected computer can be browsed to display a list of the tracks.

- When a storage device (SD, USB) on which no rekordbox library information is stored is browsed, the folders and tracks (music files) are listed in a layer structure.

Switching to the browse screen

Press the device button corresponding to the device you want to display.

When a button is pressed, the contents of the corresponding source are displayed on a list.

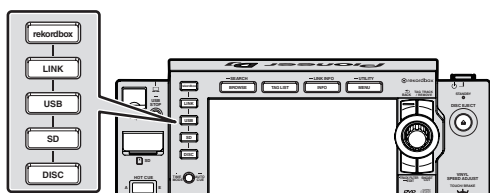

- **[DISC]** button: Displays music files on the inserted disc.
- **[SD]** button: Displays music files on the inserted SD memory card.
- **[USB]**: Displays music files in the connected USB device or mobile device on which rekordbox is installed.
- **[LINK]** button: Displays music files on a storage device (SD, USB) connected to other DJ player or mobile device on which rekordbox is installed.
- **[rekordbox]** button: Displays music files in rekordbox.
- When the browse screen is displayed, the **[BROWSE/SEARCH]** button lights.
- When the **[BROWSE/SEARCH]** button is pressed while the browse screen is displayed, the browse screen closes and the screen returns to the normal playback screen.
- When the **[BROWSE/SEARCH]** button is pressed again, the previous browse screen opens.

❖ Description of the screen

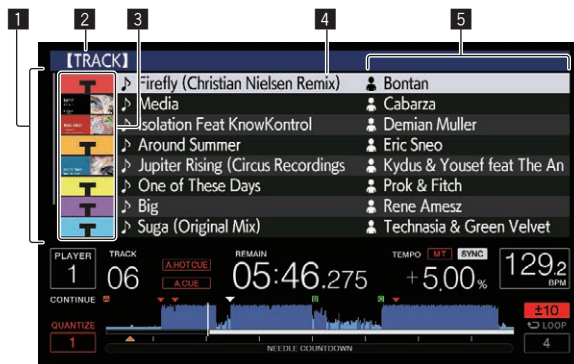

1 List of contents	The contents of the selected medium are displayed.
2 Upper level	Displays the name of the upper folder or media of the displayed item.
3 Jacket photo	Part of the artwork registered in rekordbox is displayed here. When the [INFO/LINK INFO] button is pressed, the jacket photo turns off and the track names are displayed along the left edge. For lists of playlists and playing histories, a serial number is displayed. If there is no rekordbox library, the track names are constantly displayed along the left edge.
4 Cursor	Turn the rotary selector to move the cursor up and down.
5 User-set categories	The categories displayed with rekordbox can be selected. When the [INFO/LINK INFO] button is pressed, the details of the track selected with the cursor are displayed. If there is no rekordbox library, the details of the track selected with the cursor are displayed.

❖ Distinguishing the currently playing device

The currently playing device and the device displayed on the browse screen can be distinguished according to how the device buttons are lit.

- Lit: That device is being browsed.
- Flashing: Tracks on that device are loaded.

Basic operations on the browse screen

❖ Selecting items

1 Display the browse screen.

➤ *Switching to the browse screen* (p.29)

2 Turn the rotary selector to select an item.

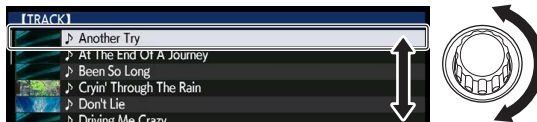

The jump function can be used by pressing the rotary selector for over 1 second.

➤ For details on the jump function, see *Searching using the jump function* on page 30.

3 Press the rotary selector to enter the item.



When there is a lower layer, that layer opens. When a menu, etc., is displayed, the selected item is entered.

When the rotary selector is pressed while the cursor is set at a track, that track is loaded in this unit.

❖ Moving back up to a higher layer

Press the [BACK] button while the browser screen is displayed.

The screen moves back to the layer above.

- When the [BACK] button is pressed for over 1 second or the medium button for the medium being browsed is pressed, the display moves to the topmost level.
- When playing the rekordbox library on a storage device (SD, USB), computer or mobile device, the information below can be displayed by pressing the [BACK] button at the topmost level.
 - When there is no rekordbox library information on the storage device (SD, USB): The device's free and used space
 - When there is rekordbox library information on the storage device (SD, USB): The device's free and used space, the number of tracks and playlists in the library information and the date they were last modified
 - rekordbox on a computer or mobile device: The number of tracks and playlists in the library information

Other browsing operations

Rearranging tracks (Sort menu)

While browsing, the sort menu can be used to change the order of the tracks.

- This function only works in the following cases:
 - When browsing the rekordbox library on a computer or mobile device
 - While browsing the rekordbox library on a storage device (SD, USB)

1 Display the rekordbox library.

- ☞ *Playing media connected to or inserted in this unit* (p.20)
- ☞ *Playing storage devices (SD, USB) of other players and mobile devices on which rekordbox is installed* (p.20)
- ☞ *Playing the rekordbox library on a computer or mobile device* (p.21)

2 When a list of the tracks is displayed, press the [MENU/UTILITY] button.

The sort menu appears on the screen.

3 Use the rotary selector to select and enter the sort item.

The tracks on the list are sorted according to the selected item.

- The sort items displayed on the sort menu can be changed in the rekordbox settings. For rekordbox libraries on storage devices (SD, USB), the settings are reflected after they are changed then re-exported.

Searching for tracks

- This function only works in the following cases:
 - When browsing the rekordbox library on a computer or mobile device
 - While browsing the rekordbox library on a storage device (SD, USB)

❖ Searching using the [SEARCH] category

In the library browse mode, tracks can be searched for using the [SEARCH] category.

1 Display the rekordbox library.

- ☞ *Playing media connected to or inserted in this unit* (p.20)
- ☞ *Playing storage devices (SD, USB) of other players and mobile devices on which rekordbox is installed* (p.20)
- ☞ *Playing the rekordbox library on a computer or mobile device* (p.21)

2 Use the rotary selector to select and enter the [SEARCH] category.

The keyboard is displayed on the touch display.

The [SEARCH] screen can be started by the following methods.

- Press the [BROWSE/SEARCH] button for over 1 second.
- Touch [SEARCH] on the [SHORTCUT] screen.

3 Input the characters using the keyboard on the touch display.

Tracks including the input characters are displayed.

- When more characters are input, tracks, etc. including the input characters are displayed.
- When the [BACK] button is pressed, the category selection screen reappears.

❖ Searching using [TRACK FILTER]

1 Display the rekordbox library.

- ☞ *Playing media connected to or inserted in this unit* (p.20)
- ☞ *Playing storage devices (SD, USB) of other players and mobile devices on which rekordbox is installed* (p.20)
- ☞ *Playing the rekordbox library on a computer or mobile device* (p.21)

2 When a track list is displayed, press the [TRACK FILTER] button.

Only the tracks that match the conditions specified with BPM, KEY, etc. are displayed.

- The condition setting screen appears if the [TRACK FILTER] button is pressed for over 1 second, and the [TRACK FILTER] conditions (tag information added to tracks, BPM, KEY, RATING, COLOR) can be set on the screen. The [TRACK FILTER] conditions can also be set with rekordbox.
- BPM and KEY of the DJ player set as the sync master can be used for the [TRACK FILTER] conditions by touching [MASTER PLAYER].
- The set conditions are recorded on each storage device (SD, USB).

Searching using the currently playing track's key

The icon for tracks whose keys are a good match with the key of the track loaded in the DJ player set as the sync master changes to the key icon (green).

Searching using the jump function

The jump function can be used to instantaneously move to the track, category or folder you want to play.

The jump function includes the two modes below.

- Letter jumping: Use this when the tracks are arranged or sorted in alphabetical order.
- Page jumping: Use this when tracks are not in alphabetical order or are not sorted.

❖ In the letter jump mode

1 Display a list sorted in alphabetical order.

Display a list that is sorted in alphabetical order, such as the rekordbox library, the track list on the storage device (SD, USB), etc.

2 Press the rotary selector for at least 1 second.

Switch to the letter jump mode. The first letter of the track or category selected with the cursor is enlarged.

3 Turn the rotary selector to select the character or symbol.

The cursor moves to tracks or categories starting with the selected character or symbol.

- If there are no tracks or categories starting with the selected character on the list, the cursor does not move. The characters displayed in the letter jump mode are letters A to Z, numbers 0 to 9 and certain symbols.

❖ In the page jump mode

1 Display a list not sorted in alphabetical order.

Display a list that is not sorted in alphabetical order, such as the tracks on a music CD, folders on a storage device (SD, USB) or a disc, etc.

2 Press the rotary selector for at least 1 second.

The mode switches to the page jump mode.

3 Turn the rotary selector to select the page.

The display moves to the selected page.

❖ Using the information jump function

The categories to which tracks belong can be displayed by selecting items displayed in the details. This function is convenient for searching for tracks in the same genre as the loaded track, tracks with similar BPMs, etc.

1 Load a track.

2 Press the [INFO/LINK INFO] button on the normal playback screen.

The track's details are displayed.

- For details, see *Displaying the details of the currently loaded track* on page 33.

3 Select and enter the item.

The screen switches to the browse screen and the category for the selected item is displayed.

- To close the browse screen, press the [BROWSE/SEARCH] button.
- It may not be possible to select items, for example for items with nothing to be displayed on the browse screen, items for which only icons are displayed in the details, etc.
- When a track is selected, the screen displayed immediately before the track was loaded is displayed.
- For tracks on disc and storage devices (SD, USB) that do not contain rekordbox libraries, only the track items can be selected.

Using hot cue banks

Hot cue banks that have been set with rekordbox ahead of time can be loaded as a set into this unit's [HOT CUE] (A to H) buttons.

1 Connect the storage device (SD, USB) on which the hot cue banks are stored to this unit.

2 Use the rotary selector to select and enter the [HOT CUE BANK] category on the browse screen.

A list of hot cue banks is displayed.

3 Use the rotary selector to select and enter the hot cue bank you want to call out.

The hot cues registered in the hot cue bank are displayed on the screen.

- The cursor is set to hot cue bank A, and cannot be moved with the rotary selector or any other button.

4 Press the rotary selector.

The hot cues set at this unit's [HOT CUE] (A to H) buttons are overwritten with the hot cues registered in the hot cue bank.

- When the hot cues stored on this unit's [HOT CUE] (A to H) buttons are overwritten with new hot cues after loading the hot cue bank, all the hot cues registered from the hot cue bank are deleted.
- Hot cue banks cannot be edited on this unit. Use rekordbox to edit hot cue banks. For details, see the rekordbox (Mac/Windows) user's manual.

Checking the playing history (HISTORY)

The track playing history is stored and displayed at the [HISTORY] category on the browse screen.

- Playlists can be created based on the playing history at [HISTORY] using rekordbox. For details, see the rekordbox (Mac/Windows) user's manual.

Storing the playing history

1 Connect a storage device (SD, USB) to this unit.

2 Play tracks.

Tracks that have been played for approximately 1 minute are stored on the playing history list.

- When a storage device (SD, USB) is connected to this unit for the first time or when it is reconnected, a new playing history list is automatically created on the storage device (SD, USB).
- The names of playing history lists can be preset at [UTILITY].
 ➔ *Setting the playing history list name* (p.36)
- When the same track is played two or more times consecutively, it may not be stored in the history.
- The maximum number of tracks that can be stored on a playing history list is 999. From the 1 000th track on, the oldest entries on the playing history are deleted to make room for the new entries. Up to 999 playing history lists can be created.
- When tracks are registered on the playing history list, their track names, etc., are displayed in green (indicating that they have been played).
- Names, etc. of the tracks in the [PLAYLIST] category can be changed to green (played) using the [MENU/UTILITY] button. When changed, the tracks are registered in the playing history list.

Deleting the playback history

1 Connect a storage device (SD, USB) to this unit.

2 Display the rekordbox library.

- ➔ *Playing media connected to or inserted in this unit* (p.20)
- ➔ *Playing storage devices (SD, USB) of other players and mobile devices on which rekordbox is installed* (p.20)
- ➔ *Playing the rekordbox library on a computer or mobile device* (p.21)

3 Use the rotary selector to select and enter the [HISTORY] category.

A list of the playing history lists is displayed.

4 Turn the rotary selector and select the playing history list to be deleted.

5 Press the [MENU/UTILITY] button.

The remove menu is displayed.

6 Turn the rotary selector to select and enter the range to be deleted.

- [DELETE]: The currently selected playing history list is deleted.
- [ALL DELETE]: All the playing history lists are deleted.
- When playing history lists on a storage device (SD, USB) are imported to rekordbox as playlists, the imported playing history lists are deleted from the storage device (SD, USB).
- Names, etc. of the tracks in the [PLAYLIST] category can be changed from green (played) to white (not played) using [MENU/UTILITY]. When changed, the tracks are deleted from the playing history list.

7 Use the rotary selector to select and enter [OK].

Editing tag lists

Tracks to be played next or tracks selected according to DJ situations can be marked and collected on lists. The list of collected tracks is called the "tag list". These tag lists can be shared in real time among multiple DJ players connected by PRO DJ LINK.

- Up to 100 tracks per device can be added to a tag list.
- One tag list is created per storage device (SD, USB). It is not possible to collect tracks from different storage devices (SD, USB) on one tag list.
- It is not possible to register the same track in the same folder twice.

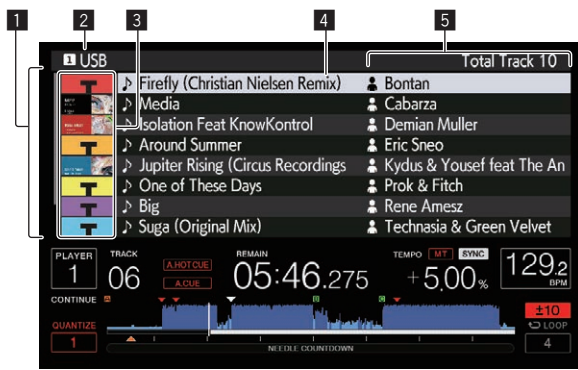

1	List of contents	The contents of the tag list are displayed here.
2	Medium name	The name of the medium on which the track is recorded is displayed here.
3	Jacket photo	Part of the artwork registered in rekordbox is displayed here. When the [INFO/LINK INFO] button is pressed, the jacket photo turns off and serial numbers are displayed.
4	Cursor	Turn the rotary selector to move the cursor up and down.
5	User-set categories	The categories displayed with rekordbox can be selected. When the [INFO/LINK INFO] button is pressed, the details of the track selected with the cursor are displayed.

Adding tracks to the tag list

❖ Selecting tracks and adding them

1 Switch to the browse screen and display the list of tracks.

2 Set the cursor to the track and press the [TAG TRACK/REMOVE] button.

☑ appears at the left of the track and that track is added to that storage device's (SD, USB) tag list.

- Tracks can be recorded in the tag list ahead of time using rekordbox.
 - ☞ For detailed operating procedure, see the rekordbox (Mac/Windows) user's manual.

❖ Adding loaded tracks

1 Load a track.

2 Press the [TAG TRACK/REMOVE] button.

The track loaded in this unit is added to the tag list.

- The tracks being loaded can be added to the tag lists by pressing the [TAG TRACK/REMOVE] button on the track's details screen.

❖ Adding entire categories or folders

All the tracks in a selected category or folder can be added to the tag list.

1 Switch to the browse screen and set the cursor to the category or folder that includes tracks directly under it.

A list of the tracks is displayed on the right half of the information display screen.

2 Press the [TAG TRACK/REMOVE] button.

The category or folder name flashes, and all the tracks in that category or folder are added to the tag list.

- When folders are added while in the folder browse mode, tracks for which ID3 tags, etc., have not been loaded a single time are registered using the file name as the track name. The artist names are not registered.
- After tracks have been added to the tag list, when the registered tracks are displayed on the track list on the browse screen or are loaded in a player and their ID3 tags, etc., are loaded, the file names switch to the track names and the artist names are also registered.

❖ Adding tracks from playlists

All the tracks on a selected playlist can be added to the tag list.

1 Switch to the browse screen and select and enter the [PLAYLIST] category.

A list of the playlists is displayed, and a list of the tracks is displayed on the right half of the information display screen.

2 Set the cursor to the playlist, then press the [TAG TRACK/REMOVE] button.

The playlist name flashes, and all the tracks on that playlist are added to the tag list.

Loading tracks from the tag list

1 Press the [TAG LIST] button.

The tag list is displayed.



- When multiple storage devices (SD, USB) are connected to the DJ player, the number of the player to which that storage device (SD, USB) is connected is displayed in front of the storage device's (SD, USB) name.

2 Use the rotary selector to select and enter the storage device (SD, USB).

When a storage device (SD, USB) is selected, the tag list on that storage device (SD, USB) is displayed.

3 Use the rotary selector to select and enter the track you want to load.

The track is loaded and playback starts.

Removing tracks from the tag list

Tracks can be removed from tag lists.

- If a track that has been added to the tag list is removed from the tag list while it is playing, the track is played to the end, then the stop mode is set. The next track is not played.

❖ Removing one track at a time

1 Press the [TAG LIST] button.

The tag list is displayed.

2 Use the rotary selector to select and enter the storage device (SD, USB).

When a storage device (SD, USB) is selected, the tag list on that storage device (SD, USB) is displayed.

3 Use the rotary selector to set the cursor to the track you want to remove.

4 Press the [TAG TRACK/REMOVE] button for over 1 second.

Tracks can be removed from tag lists by pressing the [TAG TRACK/REMOVE] button at the screens and in the situations described below.

- When the cursor is set to a track registered in the tag list on the browse screen
- When the normal playback screen or a track's details screen is displayed while a track registered in the tag list is loaded

❖ Removing all the tracks

1 Press the [TAG LIST] button.

The tag list is displayed.

2 Use the rotary selector to select and enter the storage device (SD, USB).

When a storage device (SD, USB) is selected, the tag list on that storage device (SD, USB) is displayed.

3 Press the [MENU/UTILITY] button.

[LIST MENU] is displayed.

4 Use the rotary selector to select and enter [TAGLIST MENU].

[TAGLIST MENU] is displayed.

5 Use the rotary selector to select and enter [REMOVE ALL TRACKS].

6 Use the rotary selector to select and enter [OK].

Transforming the tag list into a playlist

Tracks collected in tag lists can be converted into playlists.

- Converted playlists are displayed as items in the [PLAYLIST] category.

1 Press the [TAG LIST] button.

The tag list is displayed.

2 Use the rotary selector to select and enter the storage device (SD, USB).

When a storage device (SD, USB) is selected, the tag list on that storage device (SD, USB) is displayed.

3 Press the [MENU/UTILITY] button.

[LIST MENU] is displayed.

4 Use the rotary selector to select and enter [TAGLIST MENU].

[TAGLIST MENU] is displayed.

5 Use the rotary selector to select and enter [CREATE PLAYLIST].

6 Use the rotary selector to select and enter [OK].

The contents of the tag list are converted into a playlist with the name [TAG LIST XXX].

- Tag lists cannot be converted into playlists when no rekordbox library information is stored on the storage device (SD, USB).
- When tag lists include both tracks being managed with rekordbox and tracks not being managed with rekordbox, only the tracks being managed with rekordbox are converted into playlists.

Displaying the details of the currently loaded track

The details of the currently loaded track can be checked.

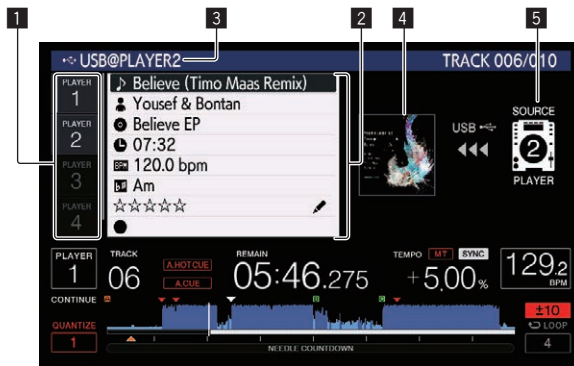

1	Player selection	The indicator of the touched player selection lights.
2	Track details	The details of the tracks loaded in the DJ player that is specified by the player selection are displayed here.
3	Medium/player number	The place where the track information is stored is displayed here.
4	Jacket photo, comment	The jacket photo and comment about the track loaded in the DJ player are displayed here.
5	Source indicator	This indicates the location of the currently loaded track.

The source indicator (5) is not displayed when a track is loaded from the media inserted to this unit.

1 Load a track.

2 Press the [INFO/LINK INFO] button on the normal playback screen.

The track's details are displayed.

- If this unit is not selected with the player selection, touch [PLAYER SELECT] to select this unit.
- The details of the tracks being loaded can be displayed by pressing the [INFO/LINK INFO] button for over 1 second on the browse or tag list screen.

Changing track ratings

The tracks' ratings can be changed.

1 Load a track.

2 Press the [INFO/LINK INFO] button on the normal playback screen.

The track's details are displayed.

3 Select the rating displayed in the detailed information (display example: ☆☆☆☆☆).

4 Press the rotary selector for over 1 second, then turn the rotary selector clockwise or counterclockwise.

The rating of the loaded track is changed.

5 Press the rotary selector and enter the rating.

Displaying details of tracks loaded in other DJ players

When another DJ player is connected by PRO DJ LINK, the details of the track loaded on the other DJ player can be checked.

1 Connect this unit and the other DJ players by PRO DJ LINK.

2 Press the [INFO/LINK INFO] button on the normal playback screen.

3 Touch the player selection to select the DJ player to view the track information of.

The details of the tracks loaded in the selected DJ player are displayed.

Changing the settings

Storing the settings on a storage device (SD, USB)

The [UTILITY] settings and other settings can be stored on a storage device (SD, USB).

The stored settings can be exported to rekordbox.

It is also to make this unit's settings with rekordbox then store them on a storage device (SD, USB) and reflect those settings on other DJ players.

- The stored settings are shown below.
 - [UTILITY] settings
PLAY MODE, EJECT/LOAD LOCK, QUANTIZE BEAT VALUE, HOT CUE AUTO LOAD, HOT CUE COLOR, AUTO CUE LEVEL, SLIP FLASHING, ON AIR DISPLAY, JOG BRIGHTNESS, JOG INDICATOR, DISC SLOT ILLUMINATION, LANGUAGE, LCD BRIGHTNESS
 - Other settings
TIME MODE (time display format on the main unit display), AUTO CUE, JOG MODE, TEMPO RANGE, MASTER TEMPO, QUANTIZE, SYNC, PHASE METER

1 Connect the storage device (SD, USB) on which you want to store the settings.

2 Press the device button (SD or USB).

When the storage device (SD, USB) on which you want to store the settings is connected to another DJ player connected by PRO DJ LINK, press the [LINK] button to select the storage device.

3 Press the [MENU/UTILITY] button.

4 Use the rotary selector to select and enter [SAVE] at [MY SETTINGS].

The settings are stored.

- The settings can also be stored on the [SHORTCUT] screen.

Calling out settings stored on a storage device (SD, USB)

The [UTILITY] settings and other settings stored on a storage device (SD, USB) can be called out.

1 Connect the storage device (SD, USB) on which the settings are stored.

2 Press the device button (SD or USB).

When the storage device (SD, USB) on which you want to store the settings is connected to another DJ player connected by PRO DJ LINK, press the [LINK] button to select the storage device.

3 Press the [MENU/UTILITY] button.

4 Use the rotary selector to select and enter [LOAD] at [MY SETTINGS].

The settings are called out.

- The settings can also be called on the [SHORTCUT] screen.

Changing the color set in a storage device (SD, USB)

The SD memory card/USB indicator color displayed when the storage media (SD, USB) is connected to this unit and a part of the display color on the screen can be changed.

1 Connect a storage device (SD, USB) to this unit.

2 Press the device button (SD or USB).

When the storage device (SD, USB) on which you want to store the settings is connected to another DJ player connected by PRO DJ LINK, press the [LINK] button to select the storage device.

3 Press the [MENU/UTILITY] button.

4 Select [BACKGROUND COLOR] of [MY SETTINGS] or [WAVE FORM COLOR] using the rotary selector.

[BACKGROUND COLOR]: Select to change the color of the SD indicator, USB indicator or a part of the display.

[WAVE FORM COLOR]: Select to change the color of overall waveform or enlarged waveform.

The colors can be changed for the storage devices (SD, USB) that include music files or management data exported from rekordbox.

5 Use the rotary selector to choose and decide the color to be set.

Displaying the [UTILITY] screen

Press the [MENU/UTILITY] button for over 1 second.

The [UTILITY] screen is displayed.

Description of the screen

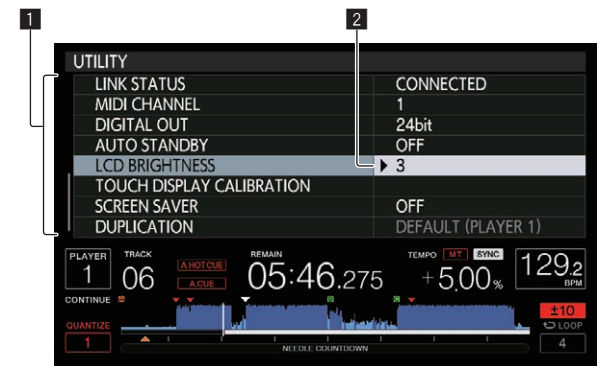

1 Setting item This unit's settings items are displayed here.

2 Setting The settings for the various items are displayed here.

Changing the settings

1 Press the [MENU/UTILITY] button for over 1 second.

The [UTILITY] screen is displayed.

2 Use the rotary selector to select the setting item.

3 Set the cursor to the item you want to change, then press the rotary selector.

The cursor moves to the setting.

4 Turn the rotary selector and change the setting.

5 Press the rotary selector to enter the setting.

The cursor returns to the setting.

- When the [BACK] button is pressed before entering the setting, the change is aborted.

6 Press the [MENU/UTILITY] button.

The screen returns to the screen displayed before the [MENU/UTILITY] button was pressed.

Setting preferences

Options settings	Setting ranges	Descriptions
PLAY MODE	CONTINUE*/SINGLE	Changes the way the tracks loaded in this unit are played. For details, see <i>Changing the play mode</i> on page 35.
EJECT/LOAD LOCK	LOCK/UNLOCK*	Sets whether to disable or enable ejecting of discs during playback and loading of new tracks during playback.
QUANTIZE BEAT VALUE	1/8, 1/4, 1/2, 1*	Changes the beat size of QUANTIZE. The setting can also be changed on the [SHORTCUT] screen.
HOT CUE AUTO LOAD	ON/rekordbox SETTING*/OFF	For details, see <i>Calling out hot cues automatically when tracks are loaded (storage device (SD, USB))</i> on page 25.
HOT CUE COLOR	ON/OFF*	The lighting color of the [HOT CUE] (A to H) buttons can be changed. For details, see <i>Lighting color of the [HOT CUE] (A to H) buttons</i> on page 25.
AUTO CUE LEVEL	-36 dB/-42 dB/-48 dB/-54 dB/-60 dB/-66 dB/-72 dB/-78 dB/MEMORY*	For details, see <i>Setting the cue point for auto cueing</i> on page 26.
SLIP FLASHING	ON*/OFF	Sets whether or not the indicators of buttons, etc., for which the slip function is activated when the [SLIP] button is pressed flash.
ON AIR DISPLAY	ON*/OFF	Selects the method of display when connected by PRO DJ LINK to an ON AIR DISPLAY compatible mixer. Also refer to the operating instructions of the ON AIR DISPLAY compatible mixer (DJM-2000, etc.).
JOG BRIGHTNESS	OFF/1/2*	Selects the brightness of the JOG RING ILLUMINATION.
JOG INDICATOR	ON*/OFF	Selects whether the JOG RING ILLUMINATION flashes or not when the track's remaining time is low.
DISC SLOT ILLUMINATION	OFF/1/2*	Sets the brightness of the disc insertion slot indicator.
LANGUAGE	—	Sets the main unit display's language.
HISTORY NAME	—	For details, see <i>Setting the playing history list name</i> on page 36.
PLAYER No.	AUTO*, 1 – 4	Sets this unit's player number. The player number cannot be changed when a medium is loaded in this unit.
LINK STATUS	—	When PRO DJ LINK connections are made, the connection status is displayed here.
MIDI CHANNEL	1* to 16	For details, see <i>Changing the MIDI channel setting</i> on page 37.
DIGITAL OUT	16 bit/24 bit*	This switches the number of bits of the audio signals output from the [DIGITAL OUT] terminal.
AUTO STANDBY	ON*/OFF	For details, see <i>Setting the auto standby mode</i> on page 35.
LCD BRIGHTNESS	1 – 3* – 5	Sets the main unit display's brightness.
TOUCH DISPLAY CALIBRATION	—	For details, see <i>Correct the alignment of touch display</i> on page 36.

Options settings	Setting ranges	Descriptions
SCREEN SAVER	ON*/OFF	When set to [ON], the screensaver starts up in the following cases: <ul style="list-style-type: none"> When no track is loaded in this unit for over 5 minutes When no operation is performed for over 100 minutes while in the pause or cue standby mode or when [END] is displayed on the main unit display.
DUPLICATION	DEFAULT*, ALL, PLAYER1-4	For details, see <i>Duplicating the settings onto DJ players connected by PRO DJ LINK</i> on page 36.
VERSION No.	—	Displays this unit's software version.

*: Setting upon purchase

Changing the play mode

1 Display the [UTILITY] screen.

➔ *Displaying the [UTILITY] screen* (p.34)

2 Use the rotary selector to select and enter [PLAY MODE].

3 Use the rotary selector to select and enter [CONTINUE] or [SINGLE].

[CONTINUE]: Moving to the previous or following track is possible in all modes.

[SINGLE]: Moving to the previous or following track is not possible with the buttons other than the [TRACK SEARCH] or [SEARCH] button, and the set cue points are canceled if the track being played is changed. The set cue points are not canceled even if the track being played is changed while tracks are loaded from a disc.

- For tracks on music CDs, operation is the same as in the [CONTINUE] mode, regardless of this setting.

Setting the auto standby mode

1 Display the [UTILITY] screen.

➔ *Displaying the [UTILITY] screen* (p.34)

2 Use the rotary selector to select and enter [AUTO STANDBY].

3 Use the rotary selector to select and enter [ON] or [OFF].

When [AUTO STANDBY] is set to [ON], the auto standby function is activated and the standby mode is set in the cases described below.

- When no operation has been performed for over 4 hours with no disc inserted, no storage device (SD, USB) connected, no device connected by PRO DJ LINK and no computer connected to the USB port (on the main unit's rear panel).
- When this unit is operated, the standby mode is canceled.
- This unit is shipped with the auto standby function turned on. If you do not want to use the auto standby function, set [AUTO STANDBY] to [OFF].

Setting the playing history list name

The name of the playing history list stored on storage devices (SD, USB) can be preset.

1 Display the [UTILITY] screen.

☞ *Displaying the [UTILITY] screen (p.34)*

2 Use the rotary selector to select and enter [HISTORY NAME].

3 Input the characters using the keyboard shown on the touch display.

4 Press the rotary selector to enter.

The name is changed to the name you have input.

- When the name of the playing history list is changed, the number after the playing history list name returns to 001. This number is incremented each time a playing history list is created.
- The maximum number of characters that can be set for the [HISTORY] name is 32, including both letters, numbers and symbols.

Changing the language

Select the language to be used for displaying track names and messages on the screen.

- When the language is changed, the messages on the main unit display are displayed in the selected language.
- When displaying track names, etc., to display characters written in local codes other than Unicode, change the [LANGUAGE] setting.

1 Display the [UTILITY] screen.

☞ *Displaying the [UTILITY] screen (p.34)*

2 Use the rotary selector to select and enter [LANGUAGE].

3 Use the rotary selector to select and enter the language.

The language of the on-screen display is changed.

Correct the alignment of touch display

1 Display the [UTILITY] screen.

☞ *Displaying the [UTILITY] screen (p.34)*

2 Use the rotary selector to select and enter [TOUCH DISPLAY CALIBRATION].

3 Touch [+] displayed on the screen, in order.

Touch 16 places in all.

- If [+] does not move when you release it, touch it a little longer and then release it.

4 Press the rotary selector to enter.

The changed settings are stored.

- When setting the calibration, do not use a pointed object like a ball-pen.

Duplicating the settings onto DJ players connected by PRO DJ LINK

The [UTILITY] settings and other settings can be duplicated onto DJ players connected by PRO DJ LINK.

- The duplicated settings are as shown below.
 - [UTILITY] settings
PLAY MODE, EJECT/LOAD LOCK, QUANTIZE BEAT VALUE, HOT CUE AUTO LOAD, HOT CUE COLOR, AUTO CUE LEVEL, SLIP FLASHING, ON AIR DISPLAY, JOG BRIGHTNESS, JOG INDICATOR, DISC SLOT ILLUMINATION, LANGUAGE, LCD BRIGHTNESS
 - Other settings
TIME MODE (time display format on the main unit display), AUTO CUE, JOG MODE, TEMPO RANGE, MASTER TEMPO, QUANTIZE, SYNC, PHASE METER

1 Select [DUPLICATION] and enter.

2 Stop playback on the DJ player(s) on which you want to reflect the settings.

3 Use the rotary selector to select and enter [PLAYER X] or [ALL].

[PLAYER1]–[PLAYER4]: The settings are duplicated on the specified DJ player. Currently playing DJ players cannot be selected.

[ALL]: The settings are duplicated on all the DJ players connected by PRO DJ LINK. The settings cannot be duplicated on currently playing DJ players.

[DUPLICATED] is displayed on the specified player's display and this unit's [UTILITY] settings and other settings are duplicated on the specified player.

[DEFAULT]: Restores this unit's settings to the settings set upon purchase.

Using the DJ software

Operating the DJ software

This unit outputs the operation information of buttons and controls, etc. in universal MIDI or HID format. When connected by a USB cable to a computer on which a MIDI- or HID-compatible DJ software program is installed, the DJ software can be operated from this unit. The sound of the music file that is playing on the computer can be output from this unit.

To use this unit as an audio device, install the driver software on the computer beforehand (p.8). This unit must also be selected in the DJ software's audio output device settings. For details, see your DJ software's operating instructions.

1 Connect the USB port on this unit to your computer.

For instructions on connections, see *Using the DJ software* on page 12.

2 Press the [BROWSE/SEARCH] button, and then press the [LINK] button.

[CONTROL MODE] and [USB-MIDI] are displayed on the menu screen.

3 Select [CONTROL MODE] and enter.

The connecting screen is displayed.

4 Select [USB-MIDI] and enter.

This unit switches to the control mode.

5 Launch the DJ software.

Communication with the DJ software starts.

- The DJ software on the computer can be operated using the buttons and rotary selector on this unit.
- It may not be possible to use some buttons to operate the DJ software.
- The control mode is canceled when a track is loaded in this unit.
- For messages output by this unit, see *List of MIDI Messages* on page 38.

Changing the MIDI channel setting

This operation is not necessary if the operation information is output in HID format.

1 Press the [MENU/UTILITY] button for over 1 second.

The utility screen appears.

2 Select [MIDI CHANNEL] and enter.

3 Turn the rotary selector.

Select the MIDI channel and change the setting. A setting from 1 – 16 can be selected.

4 Press the rotary selector to enter.

5 Press the [MENU/UTILITY] button.

The previous screen reappears.

List of MIDI Messages

SW Name	SW Type	MIDI Messages			Notes
		MSB			
JOG (TOUCH)	—	Bn	10	dd	A linear value corresponding to the speed, from stop to 4X: 64 for stop, 65 (0.06X) – 127 (4X) in the forward direction, 63 (0.06X) – 0 (4X) in the reverse direction.
NEEDLE	GUI	Bn	1C	dd	OFF = 0 1 to 127 position data from left to right side
TEMPO SLIDER	VR	Bn	1D	dd	0 – 127, 0 on the – side, 127 on the + side
TOUCH/BRAKE	VR	Bn	1E	dd	0 – 127, 0 (min.) on the left side, 127 (max.) on the right side
RELEASE/START	VR	Bn	1F	dd	0 – 127, 0 (min.) on the left side, 127 (max.) on the right side
JOG RING	—	Bn	30	dd	A linear value corresponding to the speed from 0.5X to 4X: 64 when stopped (under 0.49X), 65 (0.5X) to 127 (4X) in the forward direction, 63 (0.5X) to 0 (4X) in the reverse direction.
ENCODER	General Purpose Controller	Bn	4F	dd	98 – 127, 1 – 30 Difference of count from previous time is sent ($\pm 1 - \pm 30$) When over ± 30 , set at ± 30
PLAY/PAUSE	SW	9n	00	dd	OFF=0, ON=127
CUE	SW	9n	01	dd	OFF=0, ON=127
SEARCH FWD	SW	9n	02	dd	OFF=0, ON=127
SEARCH REV	SW	9n	03	dd	OFF=0, ON=127
TRACK SEARCH NEXT	SW	9n	04	dd	OFF=0, ON=127
TRACK SEARCH PREV	SW	9n	05	dd	OFF=0, ON=127
LOOP IN	SW	9n	06	dd	OFF=0, ON=127
LOOP OUT	SW	9n	07	dd	OFF=0, ON=127
RELOOP	SW	9n	08	dd	OFF=0, ON=127
QUANTIZE	SW	9n	09	dd	OFF=0, ON=127
MEMORY	SW	9n	0A	dd	OFF=0, ON=127
CALL NEXT	SW	9n	0B	dd	OFF=0, ON=127
CALL PREV	SW	9n	0C	dd	OFF=0, ON=127
DELETE	SW	9n	0D	dd	OFF=0, ON=127
TIME/A.CUE	SW	9n	0E	dd	OFF=0, ON=127
TEMPO RESET	SW	9n	0F	dd	OFF=0, ON=127
TEMPO RANGE	SW	9n	10	dd	OFF=0, ON=127
MT	SW	9n	11	dd	OFF=0, ON=127
JOG MODE	SW	9n	12	dd	OFF=0, ON=127
HOT CUE CALL/DELETE	SW	9n	13	dd	OFF=0, ON=127
HOT CUE E	SW	9n	14	dd	OFF=0, ON=127
HOT CUE F	SW	9n	15	dd	OFF=0, ON=127
HOT CUE G	SW	9n	16	dd	OFF=0, ON=127
HOT CUE H	SW	9n	17	dd	OFF=0, ON=127
HOT CUE A	SW	9n	18	dd	OFF=0, ON=127
HOT CUE B	SW	9n	19	dd	OFF=0, ON=127
HOT CUE C	SW	9n	1A	dd	OFF=0, ON=127
HOT CUE D	SW	9n	1B	dd	OFF=0, ON=127
MASTER	SW	9n	1E	dd	OFF=0, ON=127
SYNC	SW	9n	1F	dd	OFF=0, ON=127

SW Name	SW Type	MIDI Messages			Notes
		MSB			
JOG TOUCH	SW	9n	20	dd	OFF=0, ON=127
REVERSE	SW	9n	21	dd	OFF=0, ON=127
BEAT LOOP 1/3	GUI button	9n	22	dd	OFF=0, ON=127
BEAT LOOP 3/4	GUI button	9n	23	dd	OFF=0, ON=127
BEAT LOOP 1/16	GUI button	9n	24	dd	OFF=0, ON=127
BEAT LOOP 1/8	GUI button	9n	25	dd	OFF=0, ON=127
BEAT LOOP 1/4	GUI button	9n	26	dd	OFF=0, ON=127
BEAT LOOP 1/2	GUI button	9n	27	dd	OFF=0, ON=127
BEAT LOOP 1	GUI button	9n	28	dd	OFF=0, ON=127
BEAT LOOP 2	GUI button	9n	29	dd	OFF=0, ON=127
BEAT LOOP 4	SW/GUI button	9n	2A	dd	OFF=0, ON=127
BEAT LOOP 8	GUI button	9n	2B	dd	OFF=0, ON=127
BEAT LOOP 16	GUI button	9n	2C	dd	OFF=0, ON=127
BEAT LOOP 32	GUI button	9n	2D	dd	OFF=0, ON=127
EJECT	SW	9n	2F	dd	OFF=0, ON=127
TAG TRACK	SW	9n	30	dd	OFF=0, ON=127
BACK	SW	9n	32	dd	OFF=0, ON=127
ENCODER PUSH	SW	9n	33	dd	OFF=0, ON=127
BEAT JUMP FWD	GUI button	9n	38	dd	OFF=0, ON=127
BEAT JUMP REV	GUI button	9n	39	dd	OFF=0, ON=127
SLIP	SW	9n	3A	dd	OFF=0, ON=127
SLIP REVERSE	SW	9n	3B	dd	OFF=0, ON=127

n is the channel number.

Additional information

Troubleshooting

- Incorrect operation is often mistaken for trouble or malfunction. If you think that there is something wrong with this component, check the points below and the [FAQ] for the [CDJ-2000NXS2] on the Pioneer DJ support site.
<http://pioneerdj.com/support/>
 Sometimes the problem may lie in another component. Inspect the other components and electrical appliances being used. If the problem cannot be rectified, ask your nearest Pioneer authorized service center or your dealer to carry out repair work.
- This unit may not operate properly due to static electricity or other external influences. In this case, proper operation may be restored by turning the power off, waiting 1 minute, then turning the power back on.

Problem	Check	Remedy
Disc cannot be ejected.	Is [EJECT/LOAD LOCK] set to [LOCK]?	Press the [PLAY/PAUSE▶/II] button to set the pause mode, then press the [DISC EJECT▲] button.
	—	Set [EJECT/LOAD LOCK] at [UTILITY] to [UNLOCK], then press the [DISC EJECT▲] button. If the [DISC EJECT▲] button does not work, insert the pin into the disc force eject hole to eject the disc.
Playback does not start when disc is loaded.	Is the disc or file playable?	See <i>Usable media</i> on page 5.
	Is the auto cue function activated?	Press [AUTO CUE] for at least 1 second to turn cancel the auto cue function.
File cannot be played.	Is the file copyright-protected (by DRM)?	Copyright-protected files cannot be played.
No sound is produced, or sound is distorted or noisy.	Are you operating the connected DJ mixer properly?	Check the operation of the DJ mixer.
	Is this unit placed near a TV?	Turn the TV's power off or install this unit and TV away from each other.
Loud noise is produced or playback stops when a certain disc is played.	Is the disc scratched?	Scratched discs may not play.
	Is the disc dirty?	Wipe the dirt off the disc. (p.42)
File information is not properly displayed.	Is [LANGUAGE] properly set?	Set [LANGUAGE] to the proper language.
	Is the information recorded in a language not supported by this unit?	When creating files using DJ software, etc., record the information in a language supported by this unit.
Track search operation takes too long.	Is the auto cue function activated?	Track searching may take some time when there are long silent sections between tracks.
	—	If track searching is not possible within 10 seconds, a cue point is set at the beginning of the track.
Back cue function does not work.	Is a cue point set?	Set the cue point (p.23).
Loop play function does not work.	Is a cue point set?	Set the cue point (p.23).
Settings are not stored in the memory.	Has the power been turned off directly after changing the setting?	After changing settings, wait at least 10 seconds before turning the power off.
USB device is not recognized.	Is the USB device properly connected?	Connect the device securely (all the way in).
	Is the USB device connected via a USB hub?	USB hubs cannot be used.
	Is the USB device supported by this unit?	This player supports USB mass storage class devices. This player supports mobile devices on which rekordbox (iOS/Android) is installed.
	Is the file format supported by this unit?	Check the file format of the connected USB device. For the file formats supported by this unit, see <i>About USB devices</i> on page 6.
	—	Turn the power off then back on.
Cue or loop points are not stored on storage devices (SD, USB).	Are you trying to store more points than the limit?	The maximum number of cue or loop points that can be stored on storage devices (SD, USB) per disc is 100. For devices other than discs, the maximum limit is 10 points per track. If you try to store more points than the limit, [CUE/LOOP POINT FULL] is displayed and the points cannot be stored. In this case, delete some points before storing new ones.
	Is the storage device (SD, USB) write-protected?	When an SD memory card is write-protected, [CARD PROTECTED] is displayed and the points cannot be stored. When a USB device is write-protected, [USB FULL] is displayed and the points cannot be stored. Disable write-protection then store the points.
	Is there enough free space on the storage device (SD, USB)?	If there is not enough free space on an SD memory card, [CARD FULL] is displayed and the points cannot be stored. If there is not enough free space on a USB device, [USB FULL] is displayed and the points cannot be stored. Free some space then store the points.
Cue points or loop of tracks stored on a storage device (SD, USB) are not displayed.	Was the USB device properly stopped before it was disconnected the last time?	Points may not be displayed if the SD memory card/USB device is removed without performing the proper stopping procedure or if this unit's power is turned off. Check that the SD memory card or USB indicator is not flashing before disconnecting storage devices (SD, USB) or turning this unit's power off.

Problem	Check	Remedy
When buttons are pressed to call out the hot cue storing mode or to reloop, or when the lever is moved to set reverse playback, the operation does not start immediately.	Is the quantize function on?	When the quantize function is on, the operation starts from the nearest beat position from where buttons are pressed or the lever is moved. To start the operation immediately when buttons are pressed or the lever is moved, turn the quantize function off.
The playing address display is not displayed in the remaining time mode.	—	When playing files recorded in VBR, it may happen that the set cannot detect the length of the track immediately and that some time is required for the playing address display to appear.
Much time is required for reading storage devices (SD, USB) (flash memory devices or hard disks).	Is there a large number of folders or files stored on the storage device (SD, USB)?	When there are many folders or files, some time may be required for loading.
	Are files other than music files saved on the storage device (SD, USB)?	When files other than music files are stored in folders, time is required to read them as well. Do not store files or folders other than music files on the USB device.
Library browsing is not possible.	Is a medium on which library information is recorded loaded?	The library browse mode is only set when media on which library information is recorded are loaded. When a medium on which no library information is recorded is loaded, the folder browse mode is set.
[HISTORY] is not displayed.	Is the storage device (SD, USB) connected?	The [HISTORY] function can only be used on the DJ player to which the storage device (SD, USB) is connected.
Nothing is displayed.	Is the auto standby function activated?	This unit is shipped with the auto standby function turned on. If you do not want to use the auto standby function, set [AUTO STANDBY] to [OFF]. (p.35)
The scale is not displayed.	Is the track over 15 minutes long?	The scale is not displayed for tracks whose playing time is over 15 minutes. (p.17)
PRO DJ LINK does not work well.	Are the player numbers properly set?	Set [PLAYER No.] to [AUTO] or to a number different from the number currently set. (p.35)
	Is the LAN cable properly connected?	Connect the LAN cable properly to the [LINK] terminal.
	Is the switching hub's power turned on?	Turn the switching hub's power on.
	Is an unnecessary device connected to the switching hub?	Disconnect the unnecessary device from the switching hub.
There is no response when you touch the screen, or the response is bad. A position different from the actually touched location responds.	Calibration adjustment of touch display is deviating.	Adjust the touch display by using the [TOUCH DISPLAY CALIBRATION] settings in the [UTILITY] screen.

About the liquid crystal display

- Small black or shining points may appear on the liquid crystal display. This is a phenomenon inherent to liquid crystal displays; this is not a malfunction.
- When using in cold places, the liquid crystal display may be dark for a while after this unit's power is turned on. It will reach the normal brightness after a while.
- When the liquid crystal display is exposed to direct sunlight, the light will reflect off it, making it difficult to see. Block the direct sunlight.

Cleaning the touch display

































Do not use organic solvents, acids or alkalis for cleaning the surface of the touch display. Wipe with a dry soft cloth or a cloth immersed in neutral detergent and squeezed properly.

Error messages

When this unit cannot operate normally, an error code appears on the display. Check the table below and take the measures indicated. If an error code not shown on the table below is displayed, or if the same error code is displayed again after taking the indicated action, contact your store of purchase.

Error code	Error type	Description of error	Cause and action
E-7201	CANNOT READ DISC	TOC data cannot be read.	<ul style="list-style-type: none"> • Disc is cracked. → Replace the disc. • Disc is dirty. → Clean the disc.
E-8301	CANNOT READ DISC	Disc that cannot be played normally is loaded.	<ul style="list-style-type: none"> • If operation is normal with other discs, the problem is with that disc.
E-8302	CANNOT PLAY TRACK(****)	Track data (file) on the disc or storage device (SD, USB) cannot be read properly.	<ul style="list-style-type: none"> • The track data (file) may be corrupt. → Check whether the track (file) can be played on another player, etc., capable of playing the same formats as this unit.
E-8304 E-8305	UNSUPPORTED FILE FORMAT	Music files that cannot be played normally are loaded.	Format is wrong. → Replace with music files in the proper format.
E-9101	MECHANICAL TIMEOUT	Mechanical error (time out) during loading or ejecting of disc.	Displayed when mechanism operation is not completed within the specified time.

List of icons displayed on the main unit display section

 Genre	 Player number (1 – 4)	 SD	 Open folder	 Comment
 Artist	 Hot Cue	 Computer	 Close folder	 WAIT
 Album	 Disc	 Year	 Remixer	 rekordbox
 Track/file name	 Registered in tag list	 Label	 Original artist	 Mixer
 Playlist HISTORY Hot Cue Bank List	 Tempo (BPM)	 Key	 Search	 Edit the rating
 Rating	 Color	 Bit rate	 DJ play count	
 Time	 USB	 Playing	 Date library added	

About iPods/iPhones/iPads

- This product has been developed and tested based on the iPod/iPhone/iPad software versions indicated on the Pioneer DJ support site. (<http://pioneerdj.com/support/>)
- Compatibility with this product may be lost if software of a version other than the one indicated on the Pioneer DJ support site is installed on your iPod/iPhone/iPad.
- Note that Pioneer DJ does not offer any guarantee regarding operation of iPods/iPhones/iPads.
- Pioneer DJ will accept no responsibility whatsoever for loss of iPod/iPhone/iPad data during use.
- With iPods/iPhones/iPads, material that is not copyrighted or material for which duplication and playback is legally permitted may be duplicated and played by individuals on a private basis. Infringement of copyrights is prohibited by law.

Cautions on use

About condensation

Water droplets (condensation) may form inside the unit (on operating parts and lenses) in the winter, for example, if the unit is moved from a cold place into a warm room or if the temperature in the room in which the unit is installed rises suddenly (through heating, etc.). The unit will not operate properly and will not be playable with condensation inside. Let the unit stand for 1 to 2 hours at room temperature (though this time depends on the conditions of the condensation) without turning on the power. The water droplets will evaporate and the unit will become playable. Condensation can occur in the summer as well if the unit is exposed to the direct wind from an air-conditioner, etc. If this happens, move the unit to a different location.

Cleaning the lens

The player's lens should not become dirty in normal use, but if for some reason it should malfunction due to dust or dirt, consult your nearest Pioneer authorized service center. Although lens cleaners for players are commercially available, we advise against using them since some may damage the lens.

Handling discs

Storing

- Always place discs in their cases and store them vertically, avoiding hot, humid places, places exposed to direct sunlight and extremely cold places.
 - Be sure to read the cautions included with the disc.
-

Cleaning discs

- Discs may not play if there are fingerprints or dust on them. In this case, use a cleaning cloth, etc., to gently wipe the disc from the inside towards the outside. Do not use dirty cleaning cloths.

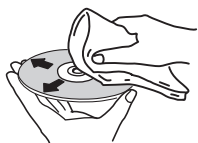

- Do not use benzene, thinner or other volatile chemicals. Also do not use record spray or antistatic agents.
- For tough dirt, apply some water to a soft cloth, wring out thoroughly, wipe off the dirt, then wipe off the moisture with a dry cloth.
- Do not use damaged (cracked or warped) discs.
- Do not let the signal surface of discs get scratched or dirty.
- Do not place two discs in the disc tray, one on top of the other.
- Do not attach pieces of paper or stickers to discs. Doing so could warp discs, making it impossible to play them. Also note that rental discs often have labels attached to them, and the label's glue may have oozed out. Check that there is no glue around the edges of such labels before using rented discs.

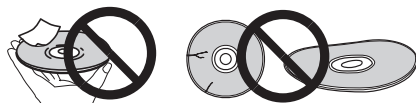

About specially shaped discs

Irregularly shaped discs other than standard 12 cm discs cannot be played on this unit (doing so will lead to damage or accidents). Specially shaped discs (heart-shaped, hexagonal, etc.) cannot be played on this unit. Do not attempt to play such discs, as they could damage the unit.



About condensation on discs

Water droplets (condensation) may form on the surface of discs if they are moved from a cold place (particularly in winter) into a warm room. Discs may not play normally if there is condensation on them. Carefully wipe the water droplets off the surface of the disc before loading it.

About trademarks and registered trademarks

- Pioneer DJ is a trademark of the PIONEER CORPORATION and is used under license. rekordbox and KUVO are trademarks or registered trademarks of the Pioneer DJ Corporation.
- Windows is a registered trademark of Microsoft Corporation in the United States and other countries.
- Adobe and Reader are either registered trademarks or trademarks of Adobe Systems Incorporated in the United States and/or other countries.
- ASIO is a trademark of Steinberg Media Technologies GmbH.
- SD Logo is a trademark of SD-3C, LLC.



- SDHC Logo is a trademark of SD-3C, LLC.



- **DVD** is a trademark of DVD Format/Logo Licensing Corporation.
- "Made for iPod," "Made for iPhone," and "Made for iPad" mean that an electronic accessory has been designed to connect specifically to iPod, iPhone, or iPad, respectively, and has been certified by the developer to meet Apple performance standards. Apple is not responsible for the operation of this device or its compliance with safety and regulatory standards. Please note that the use of this accessory with iPod, iPhone, or iPad may affect wireless performance.

Made for



iPod



iPhone



iPad

- Apple, iPad, iPhone, iPod, iPod touch, iTunes, Mac, Mac OS, and OS X are trademarks of Apple Inc., registered in the U.S. and other countries.
- iOS is a trademark on which Cisco holds the trademark right in the US and certain other countries.
- Android™ is a trademark of Google Inc.
- Wi-Fi is a registered mark of the Wi-Fi Alliance.
- The names of companies and products mentioned herein are trademarks or registered trademarks of their respective owners.

- This software is based in part on the work of the Independent JPEG Group.

About using MP3 files

This product has been licensed for nonprofit use. This product has not been licensed for commercial purposes (for profit-making use), such as broadcasting (terrestrial, satellite, cable or other types of broadcasting), streaming on the Internet, Intranet (a corporate network) or other types of networks or distributing of electronic information (online digital music distribution service). You need to acquire the corresponding licenses for such uses. For details, see <http://www.mp3licensing.com>.

Apple Lossless Audio Codec

Copyright © 2011 Apple Inc. All rights reserved.

Licensed under the Apache License, Version 2.0. You may obtain a copy of the License at <http://www.apache.org/licenses/LICENSE-2.0>

FLAC

FLAC Decoder

Copyright © 2000-2009 Josh Coalson

Copyright © 2011-2014 Xiph.Org Foundation

Redistribution and use in source and binary forms, with or without modification, are permitted provided that the following conditions are met:

- Redistributions of source code must retain the above copyright notice, this list of conditions and the following disclaimer.
- Redistributions in binary form must reproduce the above copyright notice, this list of conditions and the following disclaimer in the documentation and/or other materials provided with the distribution.
- Neither the name of the Xiph.org Foundation nor the names of its contributors may be used to endorse or promote products derived from this software without specific prior written permission.

THIS SOFTWARE IS PROVIDED BY THE COPYRIGHT HOLDERS AND CONTRIBUTORS "AS IS" AND ANY EXPRESS OR IMPLIED WARRANTIES, INCLUDING, BUT NOT LIMITED TO, THE IMPLIED WARRANTIES OF MERCHANTABILITY AND FITNESS FOR A PARTICULAR PURPOSE ARE DISCLAIMED. IN NO EVENT SHALL THE FOUNDATION OR CONTRIBUTORS BE LIABLE FOR ANY DIRECT, INDIRECT, INCIDENTAL, SPECIAL, EXEMPLARY, OR CONSEQUENTIAL DAMAGES (INCLUDING, BUT NOT LIMITED TO, PROCUREMENT OF SUBSTITUTE GOODS OR SERVICES; LOSS OF USE, DATA, OR PROFITS; OR BUSINESS INTERRUPTION) HOWEVER CAUSED AND ON ANY THEORY OF LIABILITY, WHETHER IN CONTRACT, STRICT LIABILITY, OR TORT (INCLUDING NEGLIGENCE OR OTHERWISE) ARISING IN ANY WAY OUT OF THE USE OF THIS SOFTWARE, EVEN IF ADVISED OF THE POSSIBILITY OF SUCH DAMAGE.

- The music management software rekordbox is not covered under free repair, etc. given in the warranty. Before using the rekordbox, read carefully the terms given in the "Software License Agreement" of rekordbox.
- The specifications and design of this product are subject to change without notice.

© 2015 Pioneer DJ Corporation. All rights reserved.

<DRI1290-A>